

Lecture 17
Thur. 10.29.2015

Hamilton Equations for Trebuchet and Other Things
(Ch. 5-9 of Unit 2)

Review of Hamiltonian equation derivation (Elementary trebuchet)

Hamiltonian definition from Lagrangian and γ_{mn} tensor

Hamilton's equations and Poincare invariant relations

Hamiltonian expression and contravariant γ^{mn} tensor

Hamiltonian energy and momentum conservation and symmetry coordinates

Coordinate transformation helps reduce symmetric Hamiltonian

Free-space trebuchet kinematics by symmetry

Algebraic approach

Direct approach and Superball analogy

Trebuchet vs Flinger and sports kinematics

Many approaches to Mechanics

Chapter 1. The Trebuchet: A dream problem for Galileo?

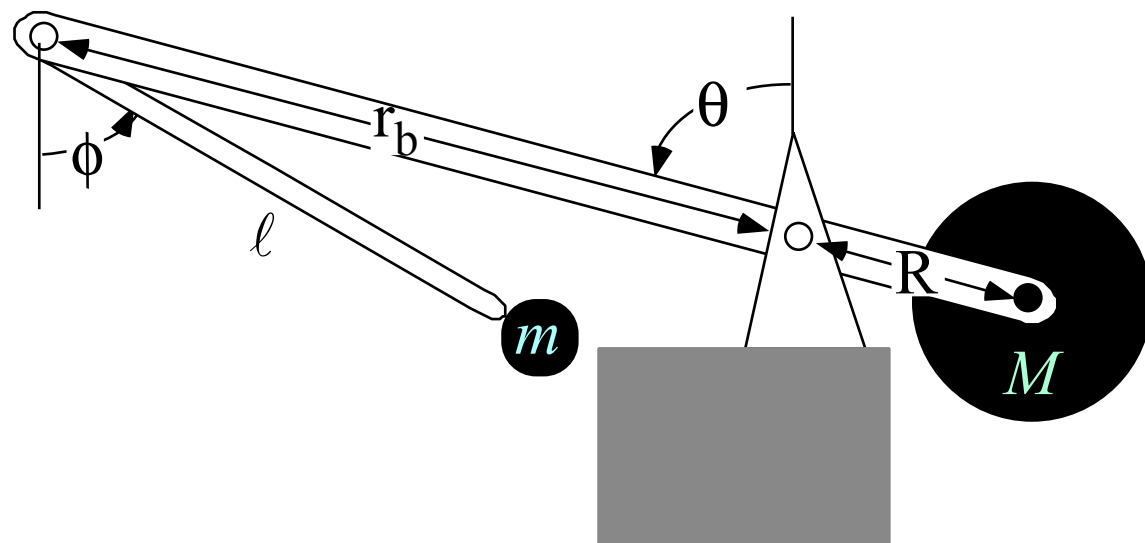
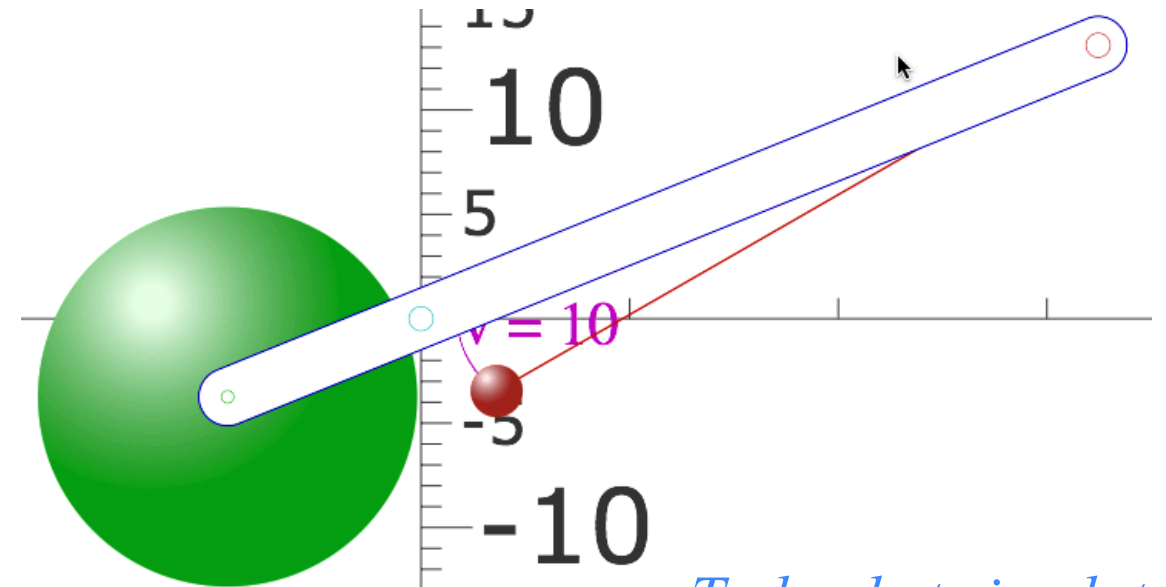
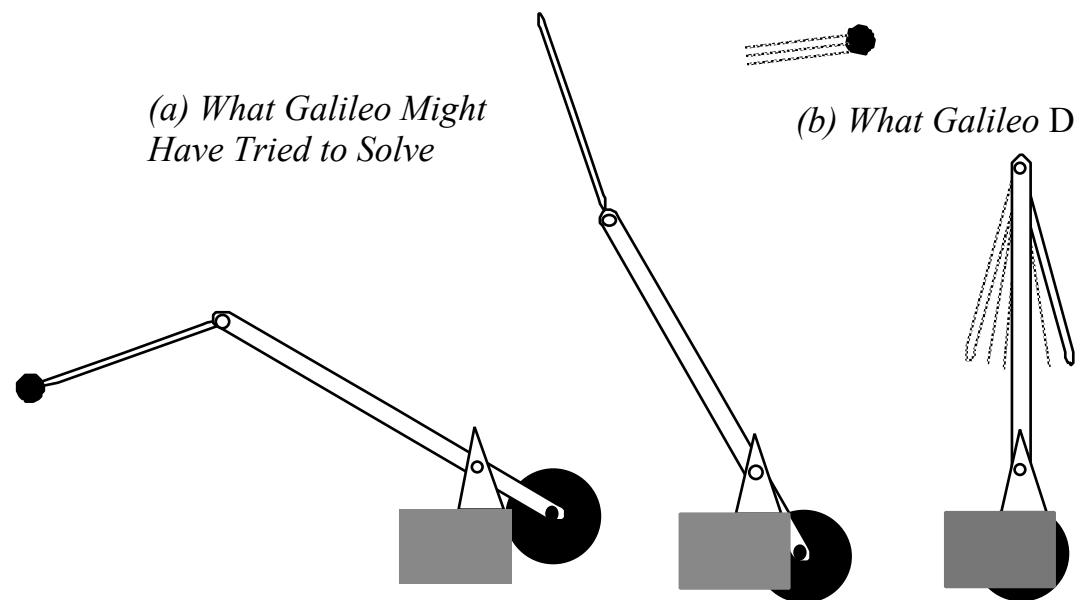

Fig. 2.1.1 An elementary ground-fixed trebuchet



Trebuchet simulator

<http://www.uark.edu/ua/modphys/markup/TrebuchetWeb.html>



(a) What Galileo Might Have Tried to Solve

(b) What Galileo Did Solve

(Simple pendulum dynamics)

Fig. 2.1.2 Galileo's (supposed) problem

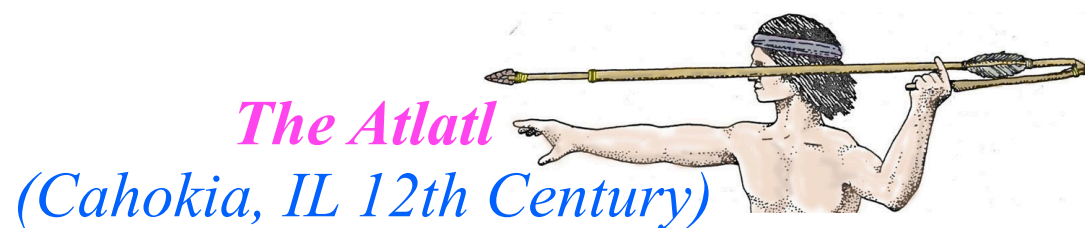

The Atlatl

(Cahokia, IL 12th Century)



Review of Hamiltonian equation derivation (Elementary trebuchet)
→ *Hamiltonian definition from Lagrangian and γ_{mn} tensor*
Hamilton's equations and Poincare invariant relations
Hamiltonian expression and contravariant γ^{mn} tensor

$$\text{Total KE} = T = \frac{1}{2} [M\dot{X}^2 + M\dot{Y}^2 + m\dot{x}^2 + m\dot{y}^2] = \frac{1}{2} [(MR^2 + mr^2)\dot{\theta}^2 - 2mrl \cos(\theta - \phi)\dot{\theta}\dot{\phi} + ml^2\dot{\phi}^2]$$

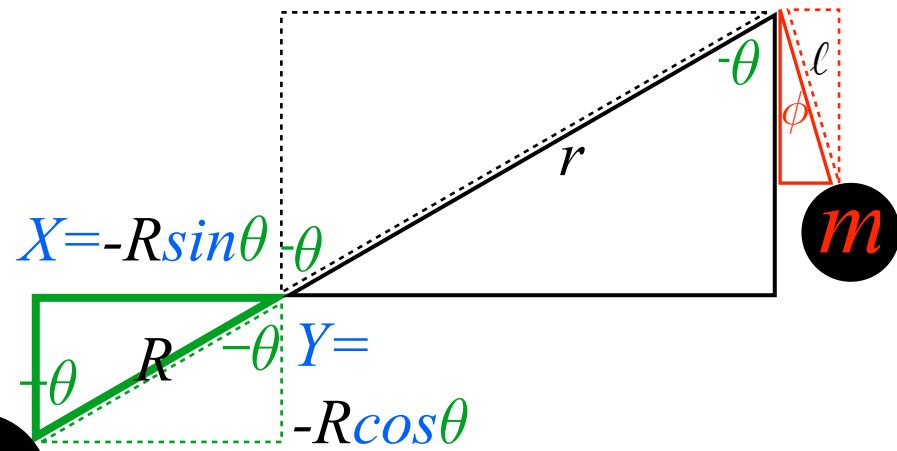

$$T = \frac{1}{2} \begin{pmatrix} \dot{\theta} & \dot{\phi} \end{pmatrix} \begin{pmatrix} MR^2 + mr^2 & -mrl \cos(\theta - \phi) \\ -mrl \cos(\theta - \phi) & ml^2 \end{pmatrix} \begin{pmatrix} \dot{\theta} \\ \dot{\phi} \end{pmatrix} = \frac{1}{2} \gamma_{mn} \dot{q}^m \dot{q}^n$$

$$\begin{pmatrix} p_{\theta} \\ p_{\phi} \end{pmatrix} = \begin{pmatrix} \gamma_{\theta,\theta} & \gamma_{\theta,\phi} \\ \gamma_{\phi,\theta} & \gamma_{\phi,\phi} \end{pmatrix} \begin{pmatrix} \dot{\theta} \\ \dot{\phi} \end{pmatrix} \quad \text{Dynamic metric tensor } \gamma_{mn} \text{ in GCC } \theta \text{ and } \phi$$

Lagrangian function of GCC and velocities: $L(\theta, \phi, \dot{\theta}, \dot{\phi}, t) = T(\theta, \phi, \dot{\theta}, \dot{\phi}, t) - V(\theta, \phi, t)$

$$dL(\theta, \phi, \dot{\theta}, \dot{\phi}, t) = \frac{\partial L}{\partial \theta} d\theta + \frac{\partial L}{\partial \phi} d\phi + \frac{\partial L}{\partial \dot{\theta}} d\dot{\theta} + \frac{\partial L}{\partial \dot{\phi}} d\dot{\phi} + \frac{\partial L}{\partial t} dt \quad \text{1st differential chain}$$

$$\text{Total KE} = T = \frac{1}{2} [M\dot{X}^2 + M\dot{Y}^2 + m\dot{x}^2 + m\dot{y}^2] = \frac{1}{2} [(MR^2 + mr^2)\dot{\theta}^2 - 2mrl \cos(\theta - \phi)\dot{\theta}\dot{\phi} + ml^2\dot{\phi}^2]$$

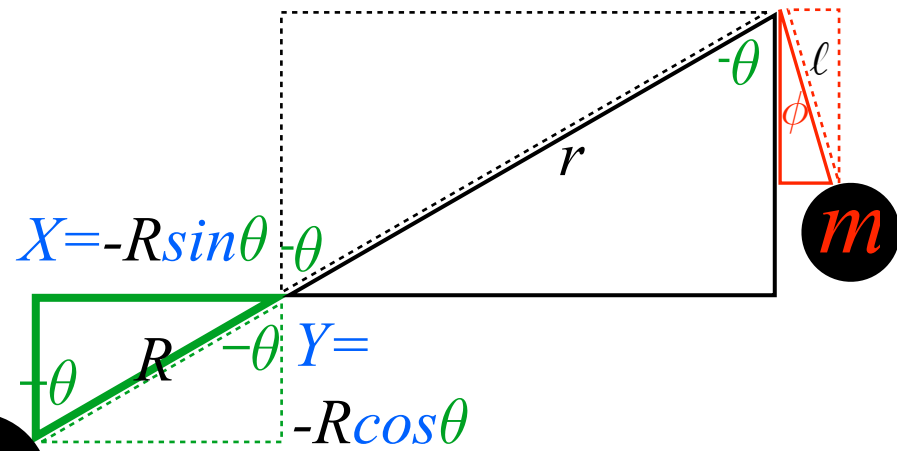

$$T = \frac{1}{2} \begin{pmatrix} \dot{\theta} & \dot{\phi} \end{pmatrix} \begin{pmatrix} MR^2 + mr^2 & -mrl \cos(\theta - \phi) \\ -mrl \cos(\theta - \phi) & ml^2 \end{pmatrix} \begin{pmatrix} \dot{\theta} \\ \dot{\phi} \end{pmatrix} = \frac{1}{2} \gamma_{mn} \dot{q}^m \dot{q}^n$$

$$\begin{pmatrix} p_{\theta} \\ p_{\phi} \end{pmatrix} = \begin{pmatrix} \gamma_{\theta,\theta} & \gamma_{\theta,\phi} \\ \gamma_{\phi,\theta} & \gamma_{\phi,\phi} \end{pmatrix} \begin{pmatrix} \dot{\theta} \\ \dot{\phi} \end{pmatrix} \quad \begin{array}{l} \text{Dynamic metric tensor} \\ \gamma_{mn} \\ \text{in GCC } \theta \text{ and } \phi \end{array}$$

Lagrangian function of GCC and velocities: $L(\theta, \phi, \dot{\theta}, \dot{\phi}, t) = T(\theta, \phi, \dot{\theta}, \dot{\phi}, t) - V(\theta, \phi, t)$

$$dL(\theta, \phi, \dot{\theta}, \dot{\phi}, t) = \frac{\partial L}{\partial \theta} d\theta + \frac{\partial L}{\partial \phi} d\phi + \frac{\partial L}{\partial \dot{\theta}} d\dot{\theta} + \frac{\partial L}{\partial \dot{\phi}} d\dot{\phi} + \frac{\partial L}{\partial t} dt \quad \text{1st differential chain}$$

$$\frac{dL}{dt} \equiv \dot{L}(\theta, \phi, \dot{\theta}, \dot{\phi}, t) = \frac{dL}{dt} = \frac{\partial L}{\partial \theta} \frac{d\theta}{dt} + \frac{\partial L}{\partial \phi} \frac{d\phi}{dt} + \frac{\partial L}{\partial \dot{\theta}} \frac{d\dot{\theta}}{dt} + \frac{\partial L}{\partial \dot{\phi}} \frac{d\dot{\phi}}{dt} + \frac{\partial L}{\partial t} \quad \text{velocity chain}$$

$$\text{Total KE} = T = \frac{1}{2} [M\dot{X}^2 + M\dot{Y}^2 + m\dot{x}^2 + m\dot{y}^2] = \frac{1}{2} [(MR^2 + mr^2)\dot{\theta}^2 - 2mrl \cos(\theta - \phi)\dot{\theta}\dot{\phi} + ml^2\dot{\phi}^2]$$

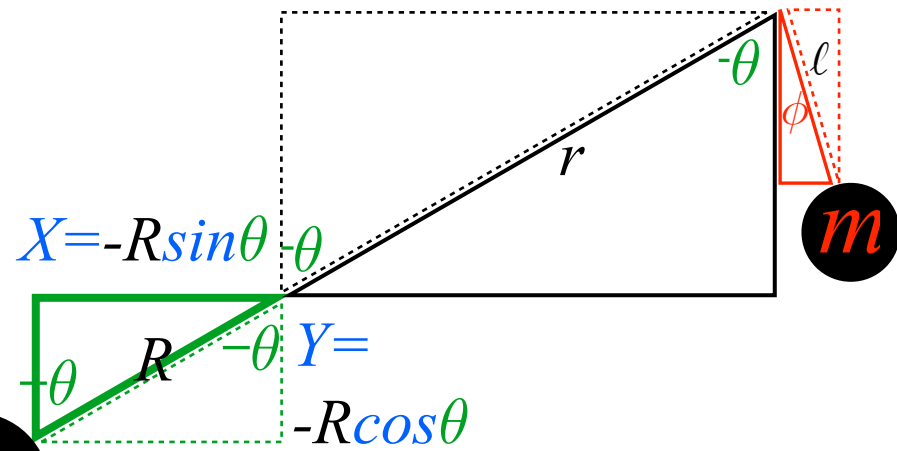

$$T = \frac{1}{2} \begin{pmatrix} \dot{\theta} & \dot{\phi} \end{pmatrix} \begin{pmatrix} MR^2 + mr^2 & -mrl \cos(\theta - \phi) \\ -mrl \cos(\theta - \phi) & ml^2 \end{pmatrix} \begin{pmatrix} \dot{\theta} \\ \dot{\phi} \end{pmatrix} = \frac{1}{2} \gamma_{mn} \dot{q}^m \dot{q}^n$$

$$\begin{pmatrix} p_{\theta} \\ p_{\phi} \end{pmatrix} = \begin{pmatrix} \gamma_{\theta,\theta} & \gamma_{\theta,\phi} \\ \gamma_{\phi,\theta} & \gamma_{\phi,\phi} \end{pmatrix} \begin{pmatrix} \dot{\theta} \\ \dot{\phi} \end{pmatrix} \quad \text{Dynamic metric tensor } \gamma_{mn} \text{ in GCC } \theta \text{ and } \phi$$

Lagrangian function of GCC and velocities: $L(\theta, \phi, \dot{\theta}, \dot{\phi}, t) = T(\theta, \phi, \dot{\theta}, \dot{\phi}, t) - V(\theta, \phi, t)$

$$dL(\theta, \phi, \dot{\theta}, \dot{\phi}, t) = \frac{\partial L}{\partial \theta} d\theta + \frac{\partial L}{\partial \phi} d\phi + \frac{\partial L}{\partial \dot{\theta}} d\dot{\theta} + \frac{\partial L}{\partial \dot{\phi}} d\dot{\phi} + \frac{\partial L}{\partial t} dt \quad \text{1st differential chain}$$

$$\dot{L}(\theta, \phi, \dot{\theta}, \dot{\phi}, t) = \frac{dL}{dt} = \frac{\partial L}{\partial \theta} \frac{d\theta}{dt} + \frac{\partial L}{\partial \phi} \frac{d\phi}{dt} + \frac{\partial L}{\partial \dot{\theta}} \frac{d\dot{\theta}}{dt} + \frac{\partial L}{\partial \dot{\phi}} \frac{d\dot{\phi}}{dt} + \frac{\partial L}{\partial t} \quad \text{velocity chain}$$

$$\dot{L}(\theta, \phi, \dot{\theta}, \dot{\phi}, t) = \frac{dL}{dt} = \dot{p}_{\theta} \frac{d\theta}{dt} + \dot{p}_{\phi} \frac{d\phi}{dt} + p_{\theta} \frac{d\dot{\theta}}{dt} + p_{\phi} \frac{d\dot{\phi}}{dt} + \frac{\partial L}{\partial t} \quad \text{Lagrange equations}$$

$$\text{Total KE} = T = \frac{1}{2} [M\dot{X}^2 + M\dot{Y}^2 + m\dot{x}^2 + m\dot{y}^2] = \frac{1}{2} [(MR^2 + mr^2)\dot{\theta}^2 - 2mrl \cos(\theta - \phi)\dot{\theta}\dot{\phi} + ml^2\dot{\phi}^2]$$

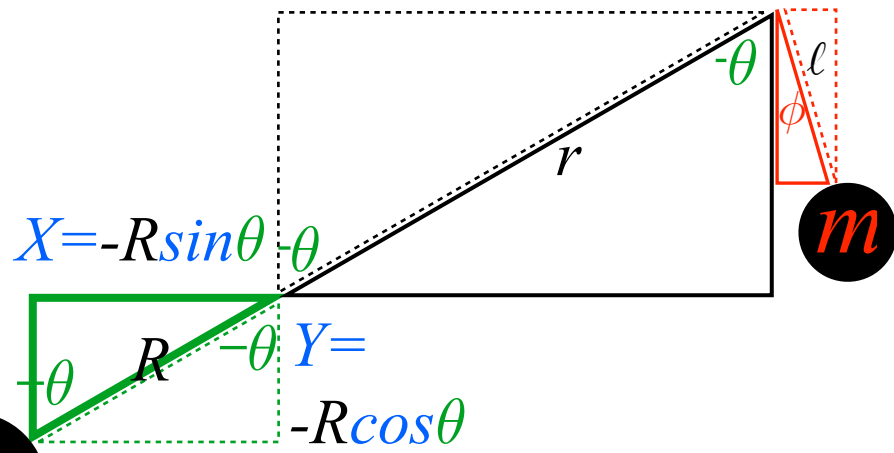

$$T = \frac{1}{2} \begin{pmatrix} \dot{\theta} & \dot{\phi} \end{pmatrix} \begin{pmatrix} MR^2 + mr^2 & -mrl \cos(\theta - \phi) \\ -mrl \cos(\theta - \phi) & ml^2 \end{pmatrix} \begin{pmatrix} \dot{\theta} \\ \dot{\phi} \end{pmatrix} = \frac{1}{2} \gamma_{mn} \dot{q}^m \dot{q}^n$$

$$\begin{pmatrix} p_{\theta} \\ p_{\phi} \end{pmatrix} = \begin{pmatrix} \gamma_{\theta,\theta} & \gamma_{\theta,\phi} \\ \gamma_{\phi,\theta} & \gamma_{\phi,\phi} \end{pmatrix} \begin{pmatrix} \dot{\theta} \\ \dot{\phi} \end{pmatrix}$$

Dynamic metric tensor
 γ_{mn}
in GCC θ and ϕ

Lagrangian function of GCC and velocities: $L(\theta, \phi, \dot{\theta}, \dot{\phi}, t) = T(\theta, \phi, \dot{\theta}, \dot{\phi}, t) - V(\theta, \phi, t)$

$$dL(\theta, \phi, \dot{\theta}, \dot{\phi}, t) = \frac{\partial L}{\partial \theta} d\theta + \frac{\partial L}{\partial \phi} d\phi + \frac{\partial L}{\partial \dot{\theta}} d\dot{\theta} + \frac{\partial L}{\partial \dot{\phi}} d\dot{\phi} + \frac{\partial L}{\partial t} dt$$

1st differential chain

$$\dot{L}(\theta, \phi, \dot{\theta}, \dot{\phi}, t) = \frac{dL}{dt} = \frac{\partial L}{\partial \theta} \frac{d\theta}{dt} + \frac{\partial L}{\partial \phi} \frac{d\phi}{dt} + \frac{\partial L}{\partial \dot{\theta}} \frac{d\dot{\theta}}{dt} + \frac{\partial L}{\partial \dot{\phi}} \frac{d\dot{\phi}}{dt} + \frac{\partial L}{\partial t}$$

velocity chain

$$\begin{aligned} \dot{L}(\theta, \phi, \dot{\theta}, \dot{\phi}, t) &= \frac{dL}{dt} = \dot{p}_{\theta} \frac{d\theta}{dt} + \dot{p}_{\phi} \frac{d\phi}{dt} + p_{\theta} \frac{d\dot{\theta}}{dt} + p_{\phi} \frac{d\dot{\phi}}{dt} + \frac{\partial L}{\partial t} \\ &= \frac{dL}{dt} = \frac{d}{dt} (p_{\theta} \dot{\theta} + p_{\phi} \dot{\phi}) + \frac{\partial L}{\partial t} \end{aligned}$$

Lagrange equations
(Consolidating)

$$\text{Total KE} = T = \frac{1}{2} [M\dot{X}^2 + M\dot{Y}^2 + m\dot{x}^2 + m\dot{y}^2] = \frac{1}{2} [(MR^2 + mr^2)\dot{\theta}^2 - 2mrl \cos(\theta - \phi)\dot{\theta}\dot{\phi} + ml^2\dot{\phi}^2]$$

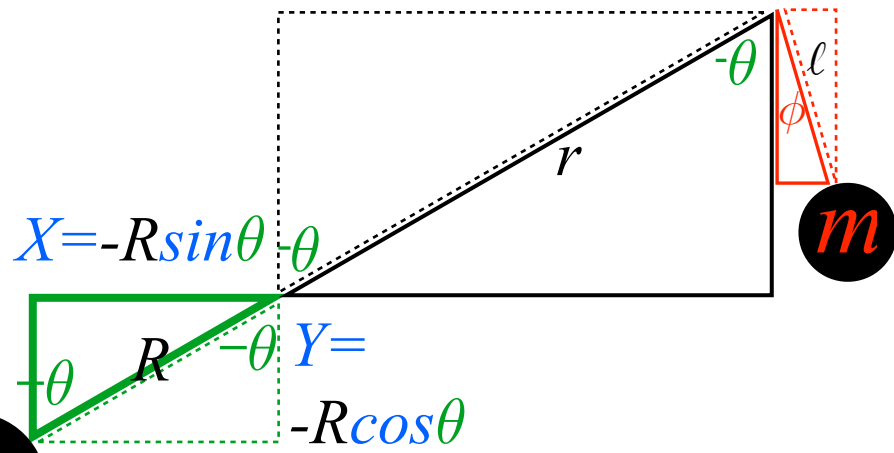

$$T = \frac{1}{2} \begin{pmatrix} \dot{\theta} & \dot{\phi} \end{pmatrix} \begin{pmatrix} MR^2 + mr^2 & -mrl \cos(\theta - \phi) \\ -mrl \cos(\theta - \phi) & ml^2 \end{pmatrix} \begin{pmatrix} \dot{\theta} \\ \dot{\phi} \end{pmatrix} = \frac{1}{2} \gamma_{mn} \dot{q}^m \dot{q}^n$$

$$\begin{pmatrix} p_{\theta} \\ p_{\phi} \end{pmatrix} = \begin{pmatrix} \gamma_{\theta,\theta} & \gamma_{\theta,\phi} \\ \gamma_{\phi,\theta} & \gamma_{\phi,\phi} \end{pmatrix} \begin{pmatrix} \dot{\theta} \\ \dot{\phi} \end{pmatrix}$$

Dynamic metric tensor

γ_{mn}
in GCC θ and ϕ

Lagrangian function of GCC and velocities: $L(\theta, \phi, \dot{\theta}, \dot{\phi}, t) = T(\theta, \phi, \dot{\theta}, \dot{\phi}, t) - V(\theta, \phi, t)$

$$dL(\theta, \phi, \dot{\theta}, \dot{\phi}, t) = \frac{\partial L}{\partial \theta} d\theta + \frac{\partial L}{\partial \phi} d\phi + \frac{\partial L}{\partial \dot{\theta}} d\dot{\theta} + \frac{\partial L}{\partial \dot{\phi}} d\dot{\phi} + \frac{\partial L}{\partial t} dt$$

$$\dot{L}(\theta, \phi, \dot{\theta}, \dot{\phi}, t) = \frac{dL}{dt} = \frac{\partial L}{\partial \theta} \frac{d\theta}{dt} + \frac{\partial L}{\partial \phi} \frac{d\phi}{dt} + \frac{\partial L}{\partial \dot{\theta}} \frac{d\dot{\theta}}{dt} + \frac{\partial L}{\partial \dot{\phi}} \frac{d\dot{\phi}}{dt} + \frac{\partial L}{\partial t}$$

velocity chain

$$\dot{L}(\theta, \phi, \dot{\theta}, \dot{\phi}, t) = \frac{dL}{dt} = \dot{p}_{\theta} \frac{d\theta}{dt} + \dot{p}_{\phi} \frac{d\phi}{dt} + p_{\theta} \frac{d\dot{\theta}}{dt} + p_{\phi} \frac{d\dot{\phi}}{dt} + \frac{\partial L}{\partial t}$$

$$= \frac{dL}{dt} = \frac{d}{dt} (p_{\theta} \dot{\theta} + p_{\phi} \dot{\phi}) + \frac{\partial L}{\partial t}$$

Lagrange equations

(Consolidating)

$$\frac{d}{dt} (p_{\theta} \dot{\theta} + p_{\phi} \dot{\phi} - L) = -\frac{\partial L}{\partial t}$$

(Rearranging)

$$\text{Total KE} = T = \frac{1}{2} [M\dot{X}^2 + M\dot{Y}^2 + m\dot{x}^2 + m\dot{y}^2] = \frac{1}{2} [(MR^2 + mr^2)\dot{\theta}^2 - 2mrl \cos(\theta - \phi)\dot{\theta}\dot{\phi} + ml^2\dot{\phi}^2]$$

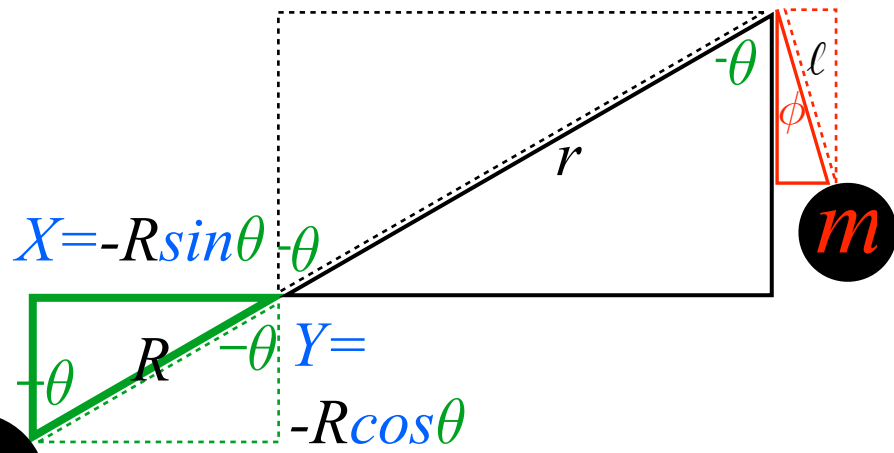

$$T = \frac{1}{2} \begin{pmatrix} \dot{\theta} & \dot{\phi} \end{pmatrix} \begin{pmatrix} MR^2 + mr^2 & -mrl \cos(\theta - \phi) \\ -mrl \cos(\theta - \phi) & ml^2 \end{pmatrix} \begin{pmatrix} \dot{\theta} \\ \dot{\phi} \end{pmatrix} = \frac{1}{2} \gamma_{mn} \dot{q}^m \dot{q}^n$$

$$\begin{pmatrix} p_{\theta} \\ p_{\phi} \end{pmatrix} = \begin{pmatrix} \gamma_{\theta,\theta} & \gamma_{\theta,\phi} \\ \gamma_{\phi,\theta} & \gamma_{\phi,\phi} \end{pmatrix} \begin{pmatrix} \dot{\theta} \\ \dot{\phi} \end{pmatrix}$$

Dynamic metric tensor

γ_{mn}
in GCC θ and ϕ

Lagrangian function of GCC and velocities: $L(\theta, \phi, \dot{\theta}, \dot{\phi}, t) = T(\theta, \phi, \dot{\theta}, \dot{\phi}, t) - V(\theta, \phi, t)$

$$dL(\theta, \phi, \dot{\theta}, \dot{\phi}, t) = \frac{\partial L}{\partial \theta} d\theta + \frac{\partial L}{\partial \phi} d\phi + \frac{\partial L}{\partial \dot{\theta}} d\dot{\theta} + \frac{\partial L}{\partial \dot{\phi}} d\dot{\phi} + \frac{\partial L}{\partial t} dt$$

$$\dot{L}(\theta, \phi, \dot{\theta}, \dot{\phi}, t) = \frac{dL}{dt} = \frac{\partial L}{\partial \theta} \frac{d\theta}{dt} + \frac{\partial L}{\partial \phi} \frac{d\phi}{dt} + \frac{\partial L}{\partial \dot{\theta}} \frac{d\dot{\theta}}{dt} + \frac{\partial L}{\partial \dot{\phi}} \frac{d\dot{\phi}}{dt} + \frac{\partial L}{\partial t}$$

velocity chain

$$\dot{L}(\theta, \phi, \dot{\theta}, \dot{\phi}, t) = \frac{dL}{dt} = \dot{p}_{\theta} \frac{d\theta}{dt} + \dot{p}_{\phi} \frac{d\phi}{dt} + p_{\theta} \frac{d\dot{\theta}}{dt} + p_{\phi} \frac{d\dot{\phi}}{dt} + \frac{\partial L}{\partial t}$$

Lagrange equations

$$= \frac{dL}{dt} = \frac{d}{dt} (p_{\theta} \dot{\theta} + p_{\phi} \dot{\phi}) + \frac{\partial L}{\partial t}$$

(Consolidating)

$$\frac{d}{dt} (p_{\theta} \dot{\theta} + p_{\phi} \dot{\phi} - L) = -\frac{\partial L}{\partial t}$$

(Rearranging)

$$\frac{dH}{dt} = -\frac{\partial L}{\partial t}$$

Defining the
Hamiltonian function

Hamiltonian function of GCC and momenta: $H(\theta, \phi, p_{\theta}, p_{\phi}, t) = p_{\theta} \dot{\theta} + p_{\phi} \dot{\phi} - L$

Review of Hamiltonian equation derivation (Elementary trebuchet)
Hamiltonian definition from Lagrangian and γ_{mn} tensor
 *Hamilton's equations and Poincare invariant relations*
Hamiltonian expression and contravariant γ^{mn} tensor

$$\text{Total KE} = T = \frac{1}{2} [M\dot{X}^2 + M\dot{Y}^2 + m\dot{x}^2 + m\dot{y}^2] = \frac{1}{2} [(MR^2 + mr^2)\dot{\theta}^2 - 2mrl \cos(\theta - \phi)\dot{\theta}\dot{\phi} + ml^2\dot{\phi}^2]$$

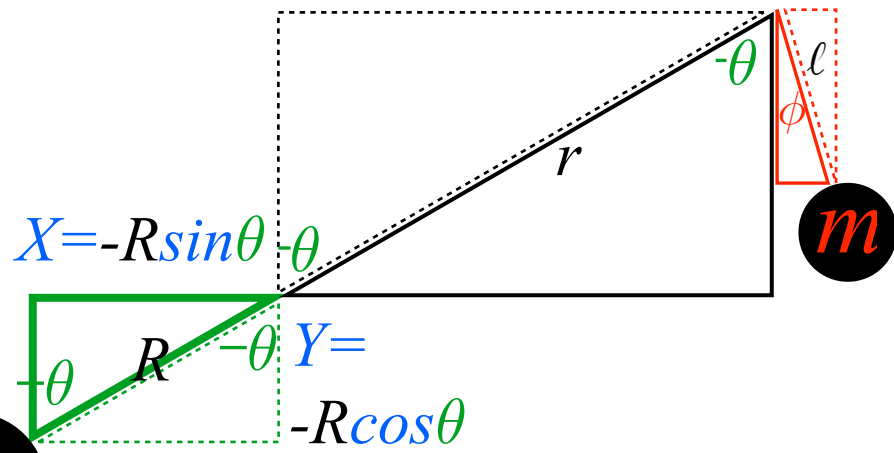

$$T = \frac{1}{2} \begin{pmatrix} \dot{\theta} & \dot{\phi} \end{pmatrix} \begin{pmatrix} MR^2 + mr^2 & -mrl \cos(\theta - \phi) \\ -mrl \cos(\theta - \phi) & ml^2 \end{pmatrix} \begin{pmatrix} \dot{\theta} \\ \dot{\phi} \end{pmatrix} = \frac{1}{2} \gamma_{mn} \dot{q}^m \dot{q}^n$$

$$\begin{pmatrix} p_{\theta} \\ p_{\phi} \end{pmatrix} = \begin{pmatrix} \gamma_{\theta,\theta} & \gamma_{\theta,\phi} \\ \gamma_{\phi,\theta} & \gamma_{\phi,\phi} \end{pmatrix} \begin{pmatrix} \dot{\theta} \\ \dot{\phi} \end{pmatrix}$$

Dynamic metric tensor
 γ_{mn}
in GCC θ and ϕ

Lagrangian function of GCC and velocities: $L(\theta, \phi, \dot{\theta}, \dot{\phi}, t) = T(\theta, \phi, \dot{\theta}, \dot{\phi}, t) - V(\theta, \phi, t)$

$$dL(\theta, \phi, \dot{\theta}, \dot{\phi}, t) = \frac{\partial L}{\partial \theta} d\theta + \frac{\partial L}{\partial \phi} d\phi + \frac{\partial L}{\partial \dot{\theta}} d\dot{\theta} + \frac{\partial L}{\partial \dot{\phi}} d\dot{\phi} + \frac{\partial L}{\partial t} dt$$

$$\dot{L}(\theta, \phi, \dot{\theta}, \dot{\phi}, t) = \frac{dL}{dt} = \frac{\partial L}{\partial \theta} \frac{d\theta}{dt} + \frac{\partial L}{\partial \phi} \frac{d\phi}{dt} + \frac{\partial L}{\partial \dot{\theta}} \frac{d\dot{\theta}}{dt} + \frac{\partial L}{\partial \dot{\phi}} \frac{d\dot{\phi}}{dt} + \frac{\partial L}{\partial t}$$

velocity chain

$$\dot{L}(\theta, \phi, \dot{\theta}, \dot{\phi}, t) = \frac{dL}{dt} = \dot{p}_{\theta} \frac{d\theta}{dt} + \dot{p}_{\phi} \frac{d\phi}{dt} + p_{\theta} \frac{d\dot{\theta}}{dt} + p_{\phi} \frac{d\dot{\phi}}{dt} + \frac{\partial L}{\partial t}$$

Lagrange equations

$$= \frac{dL}{dt} = \frac{d}{dt} (p_{\theta} \dot{\theta} + p_{\phi} \dot{\phi}) + \frac{\partial L}{\partial t}$$

(Consolidating)

$$\frac{d}{dt} (p_{\theta} \dot{\theta} + p_{\phi} \dot{\phi} - L) = -\frac{\partial L}{\partial t}$$

(Rearranging)

$$\frac{dH}{dt} = -\frac{\partial L}{\partial t}$$

Defining the Hamiltonian function

Hamiltonian function of GCC and momenta: $H(\theta, \phi, p_{\theta}, p_{\phi}, t) = p_{\theta} \dot{\theta} + p_{\phi} \dot{\phi} - L$

$$\text{Total KE} = T = \frac{1}{2} [M\dot{X}^2 + M\dot{Y}^2 + m\dot{x}^2 + m\dot{y}^2] = \frac{1}{2} [(MR^2 + mr^2)\dot{\theta}^2 - 2mrl \cos(\theta - \phi)\dot{\theta}\dot{\phi} + ml^2\dot{\phi}^2]$$

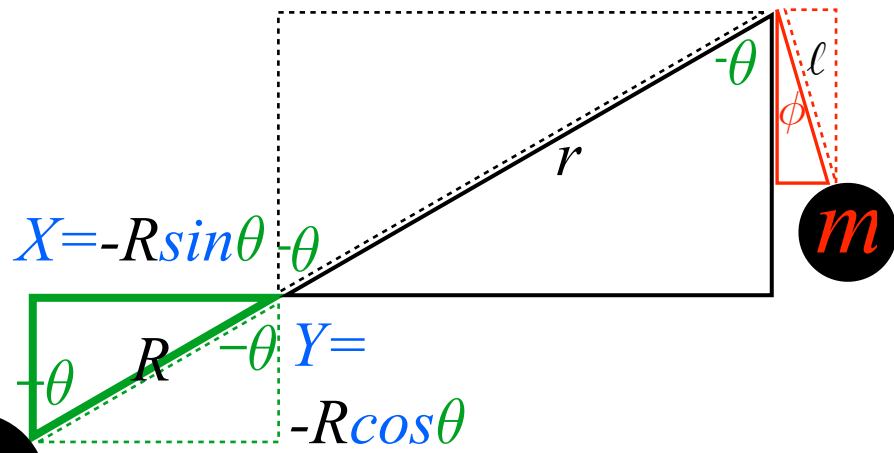

$$T = \frac{1}{2} \begin{pmatrix} \dot{\theta} & \dot{\phi} \end{pmatrix} \begin{pmatrix} MR^2 + mr^2 & -mrl \cos(\theta - \phi) \\ -mrl \cos(\theta - \phi) & ml^2 \end{pmatrix} \begin{pmatrix} \dot{\theta} \\ \dot{\phi} \end{pmatrix} = \frac{1}{2} \gamma_{mn} \dot{q}^m \dot{q}^n$$

$$\begin{pmatrix} p_{\theta} \\ p_{\phi} \end{pmatrix} = \begin{pmatrix} \gamma_{\theta,\theta} & \gamma_{\theta,\phi} \\ \gamma_{\phi,\theta} & \gamma_{\phi,\phi} \end{pmatrix} \begin{pmatrix} \dot{\theta} \\ \dot{\phi} \end{pmatrix}$$

Dynamic metric tensor

γ_{mn}
in GCC θ and ϕ

Lagrangian function of GCC and velocities: $L(\theta, \phi, \dot{\theta}, \dot{\phi}, t) = T(\theta, \phi, \dot{\theta}, \dot{\phi}, t) - V(\theta, \phi, t)$

$$dL(\theta, \phi, \dot{\theta}, \dot{\phi}, t) = \frac{\partial L}{\partial \theta} d\theta + \frac{\partial L}{\partial \phi} d\phi + \frac{\partial L}{\partial \dot{\theta}} d\dot{\theta} + \frac{\partial L}{\partial \dot{\phi}} d\dot{\phi} + \frac{\partial L}{\partial t} dt$$

$$\dot{L}(\theta, \phi, \dot{\theta}, \dot{\phi}, t) = \frac{dL}{dt} = \frac{\partial L}{\partial \theta} \frac{d\theta}{dt} + \frac{\partial L}{\partial \phi} \frac{d\phi}{dt} + \frac{\partial L}{\partial \dot{\theta}} \frac{d\dot{\theta}}{dt} + \frac{\partial L}{\partial \dot{\phi}} \frac{d\dot{\phi}}{dt} + \frac{\partial L}{\partial t}$$

velocity chain

$$\dot{L}(\theta, \phi, \dot{\theta}, \dot{\phi}, t) = \frac{dL}{dt} = \dot{p}_{\theta} \frac{d\theta}{dt} + \dot{p}_{\phi} \frac{d\phi}{dt} + p_{\theta} \frac{d\dot{\theta}}{dt} + p_{\phi} \frac{d\dot{\phi}}{dt} + \frac{\partial L}{\partial t}$$

Lagrange equations

$$= \frac{dL}{dt} = \frac{d}{dt} (p_{\theta} \dot{\theta} + p_{\phi} \dot{\phi}) + \frac{\partial L}{\partial t}$$

(Consolidating)

$$\frac{d}{dt} (p_{\theta} \dot{\theta} + p_{\phi} \dot{\phi} - L) = -\frac{\partial L}{\partial t}$$

(Rearranging)

$$\frac{dH}{dt} = -\frac{\partial L}{\partial t}$$

Defining the Hamiltonian function

Hamiltonian function of GCC and momenta: $H(\theta, \phi, p_{\theta}, p_{\phi}, t) = p_{\theta} \dot{\theta} + p_{\phi} \dot{\phi} - L$ by assumed Lagrange functionality

$$\frac{\partial H}{\partial \theta} = -\frac{\partial L}{\partial \theta} = -\dot{p}_{\theta}$$

by Lagrange equations

$$\text{Total KE} = T = \frac{1}{2} [M\dot{X}^2 + M\dot{Y}^2 + m\dot{x}^2 + m\dot{y}^2] = \frac{1}{2} [(MR^2 + mr^2)\dot{\theta}^2 - 2mrl \cos(\theta - \phi)\dot{\theta}\dot{\phi} + ml^2\dot{\phi}^2]$$

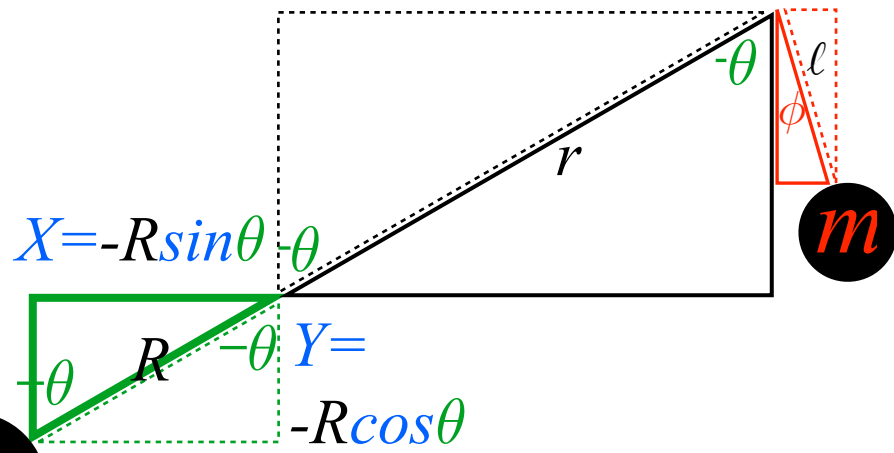

$$T = \frac{1}{2} \begin{pmatrix} \dot{\theta} & \dot{\phi} \end{pmatrix} \begin{pmatrix} MR^2 + mr^2 & -mrl \cos(\theta - \phi) \\ -mrl \cos(\theta - \phi) & ml^2 \end{pmatrix} \begin{pmatrix} \dot{\theta} \\ \dot{\phi} \end{pmatrix} = \frac{1}{2} \gamma_{mn} \dot{q}^m \dot{q}^n$$

$$\begin{pmatrix} p_{\theta} \\ p_{\phi} \end{pmatrix} = \begin{pmatrix} \gamma_{\theta,\theta} & \gamma_{\theta,\phi} \\ \gamma_{\phi,\theta} & \gamma_{\phi,\phi} \end{pmatrix} \begin{pmatrix} \dot{\theta} \\ \dot{\phi} \end{pmatrix}$$

Dynamic metric tensor
 γ_{mn}
in GCC θ and ϕ

Lagrangian function of GCC and velocities: $L(\theta, \phi, \dot{\theta}, \dot{\phi}, t) = T(\theta, \phi, \dot{\theta}, \dot{\phi}, t) - V(\theta, \phi, t)$

$$dL(\theta, \phi, \dot{\theta}, \dot{\phi}, t) = \frac{\partial L}{\partial \theta} d\theta + \frac{\partial L}{\partial \phi} d\phi + \frac{\partial L}{\partial \dot{\theta}} d\dot{\theta} + \frac{\partial L}{\partial \dot{\phi}} d\dot{\phi} + \frac{\partial L}{\partial t} dt$$

$$\dot{L}(\theta, \phi, \dot{\theta}, \dot{\phi}, t) = \frac{dL}{dt} = \frac{\partial L}{\partial \theta} \frac{d\theta}{dt} + \frac{\partial L}{\partial \phi} \frac{d\phi}{dt} + \frac{\partial L}{\partial \dot{\theta}} \frac{d\dot{\theta}}{dt} + \frac{\partial L}{\partial \dot{\phi}} \frac{d\dot{\phi}}{dt} + \frac{\partial L}{\partial t}$$

velocity chain

$$\dot{L}(\theta, \phi, \dot{\theta}, \dot{\phi}, t) = \frac{dL}{dt} = \dot{p}_{\theta} \frac{d\theta}{dt} + \dot{p}_{\phi} \frac{d\phi}{dt} + p_{\theta} \frac{d\dot{\theta}}{dt} + p_{\phi} \frac{d\dot{\phi}}{dt} + \frac{\partial L}{\partial t}$$

Lagrange equations

$$= \frac{dL}{dt} = \frac{d}{dt} (p_{\theta} \dot{\theta} + p_{\phi} \dot{\phi}) + \frac{\partial L}{\partial t}$$

(Consolidating)

$$\frac{d}{dt} (p_{\theta} \dot{\theta} + p_{\phi} \dot{\phi} - L) = -\frac{\partial L}{\partial t}$$

(Rearranging)

$$\frac{dH}{dt} = -\frac{\partial L}{\partial t}$$

Defining the Hamiltonian function

Hamiltonian function of GCC and momenta: $H(\theta, \phi, p_{\theta}, p_{\phi}, t) = p_{\theta} \dot{\theta} + p_{\phi} \dot{\phi} - L$ by assumed Lagrange functionality

$$\frac{\partial H}{\partial \theta} = -\frac{\partial L}{\partial \theta} = -\dot{p}_{\theta} \quad \frac{\partial H}{\partial p_{\theta}} = \dot{\theta} - \frac{\partial L}{\partial p_{\theta}} = \dot{\theta}$$

by Lagrange equations

$$\text{Total KE} = T = \frac{1}{2} [M\dot{X}^2 + M\dot{Y}^2 + m\dot{x}^2 + m\dot{y}^2] = \frac{1}{2} [(MR^2 + mr^2)\dot{\theta}^2 - 2mrl \cos(\theta - \phi)\dot{\theta}\dot{\phi} + ml^2\dot{\phi}^2]$$

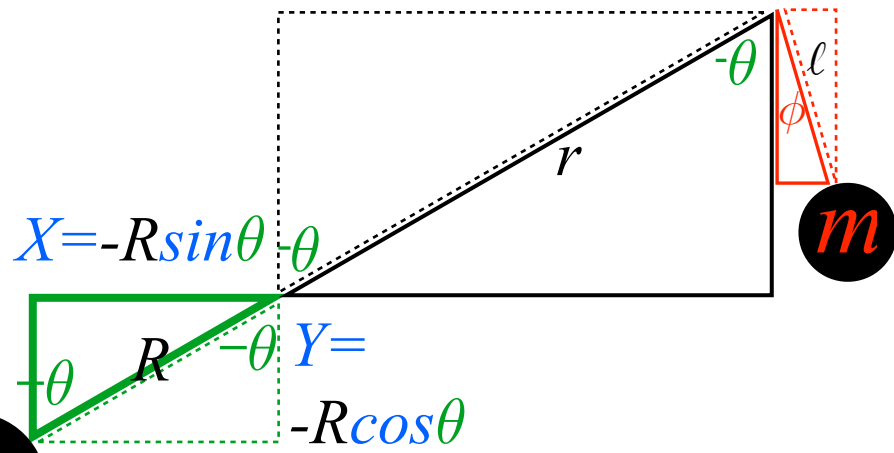

$$T = \frac{1}{2} \begin{pmatrix} \dot{\theta} & \dot{\phi} \end{pmatrix} \begin{pmatrix} MR^2 + mr^2 & -mrl \cos(\theta - \phi) \\ -mrl \cos(\theta - \phi) & ml^2 \end{pmatrix} \begin{pmatrix} \dot{\theta} \\ \dot{\phi} \end{pmatrix} = \frac{1}{2} \gamma_{mn} \dot{q}^m \dot{q}^n$$

$$\begin{pmatrix} p_{\theta} \\ p_{\phi} \end{pmatrix} = \begin{pmatrix} \gamma_{\theta,\theta} & \gamma_{\theta,\phi} \\ \gamma_{\phi,\theta} & \gamma_{\phi,\phi} \end{pmatrix} \begin{pmatrix} \dot{\theta} \\ \dot{\phi} \end{pmatrix}$$

Dynamic metric tensor

γ_{mn}
in GCC θ and ϕ

Lagrangian function of GCC and velocities: $L(\theta, \phi, \dot{\theta}, \dot{\phi}, t) = T(\theta, \phi, \dot{\theta}, \dot{\phi}, t) - V(\theta, \phi, t)$

$$dL(\theta, \phi, \dot{\theta}, \dot{\phi}, t) = \frac{\partial L}{\partial \theta} d\theta + \frac{\partial L}{\partial \phi} d\phi + \frac{\partial L}{\partial \dot{\theta}} d\dot{\theta} + \frac{\partial L}{\partial \dot{\phi}} d\dot{\phi} + \frac{\partial L}{\partial t} dt$$

$$\dot{L}(\theta, \phi, \dot{\theta}, \dot{\phi}, t) = \frac{dL}{dt} = \frac{\partial L}{\partial \theta} \frac{d\theta}{dt} + \frac{\partial L}{\partial \phi} \frac{d\phi}{dt} + \frac{\partial L}{\partial \dot{\theta}} \frac{d\dot{\theta}}{dt} + \frac{\partial L}{\partial \dot{\phi}} \frac{d\dot{\phi}}{dt} + \frac{\partial L}{\partial t}$$

velocity chain

$$\dot{L}(\theta, \phi, \dot{\theta}, \dot{\phi}, t) = \frac{dL}{dt} = \dot{p}_{\theta} \frac{d\theta}{dt} + \dot{p}_{\phi} \frac{d\phi}{dt} + p_{\theta} \frac{d\dot{\theta}}{dt} + p_{\phi} \frac{d\dot{\phi}}{dt} + \frac{\partial L}{\partial t}$$

Lagrange equations

$$= \frac{dL}{dt} = \frac{d}{dt} (p_{\theta} \dot{\theta} + p_{\phi} \dot{\phi}) + \frac{\partial L}{\partial t}$$

(Consolidating)

$$\frac{d}{dt} (p_{\theta} \dot{\theta} + p_{\phi} \dot{\phi} - L) = -\frac{\partial L}{\partial t}$$

(Rearranging)

$$\frac{dH}{dt} = -\frac{\partial L}{\partial t}$$

Defining the
Hamiltonian function

Hamiltonian function of GCC and momenta: $H(\theta, \phi, p_{\theta}, p_{\phi}, t) = p_{\theta} \dot{\theta} + p_{\phi} \dot{\phi} - L$ by assumed Lagrange functionality

$$\frac{\partial H}{\partial \theta} = -\frac{\partial L}{\partial \theta} = -\dot{p}_{\theta} \quad \frac{\partial H}{\partial p_{\theta}} = \dot{\theta} - \frac{\partial L}{\partial p_{\theta}} = \dot{\theta} \quad \frac{\partial H}{\partial \dot{\theta}} = p_{\theta} - \frac{\partial L}{\partial \dot{\theta}} = 0$$

by Lagrange equations

$$\text{Total KE} = T = \frac{1}{2} [M\dot{X}^2 + M\dot{Y}^2 + m\dot{x}^2 + m\dot{y}^2] = \frac{1}{2} [(MR^2 + mr^2)\dot{\theta}^2 - 2mrl \cos(\theta - \phi)\dot{\theta}\dot{\phi} + ml^2\dot{\phi}^2]$$

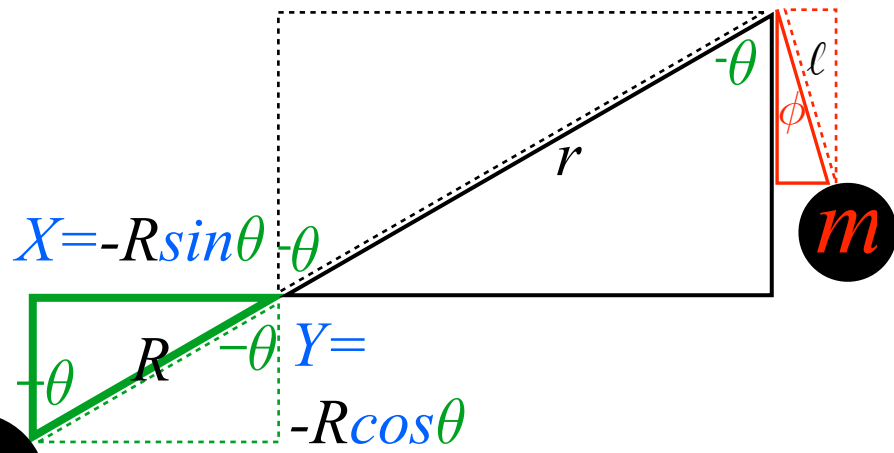

$$T = \frac{1}{2} \begin{pmatrix} \dot{\theta} & \dot{\phi} \end{pmatrix} \begin{pmatrix} MR^2 + mr^2 & -mrl \cos(\theta - \phi) \\ -mrl \cos(\theta - \phi) & ml^2 \end{pmatrix} \begin{pmatrix} \dot{\theta} \\ \dot{\phi} \end{pmatrix} = \frac{1}{2} \gamma_{mn} \dot{q}^m \dot{q}^n$$

$$\begin{pmatrix} p_{\theta} \\ p_{\phi} \end{pmatrix} = \begin{pmatrix} \gamma_{\theta,\theta} & \gamma_{\theta,\phi} \\ \gamma_{\phi,\theta} & \gamma_{\phi,\phi} \end{pmatrix} \begin{pmatrix} \dot{\theta} \\ \dot{\phi} \end{pmatrix}$$

Dynamic metric tensor

γ_{mn}
in GCC θ and ϕ

Lagrangian function of GCC and velocities: $L(\theta, \phi, \dot{\theta}, \dot{\phi}, t) = T(\theta, \phi, \dot{\theta}, \dot{\phi}, t) - V(\theta, \phi, t)$

$$dL(\theta, \phi, \dot{\theta}, \dot{\phi}, t) = \frac{\partial L}{\partial \theta} d\theta + \frac{\partial L}{\partial \phi} d\phi + \frac{\partial L}{\partial \dot{\theta}} d\dot{\theta} + \frac{\partial L}{\partial \dot{\phi}} d\dot{\phi} + \frac{\partial L}{\partial t} dt$$

$$\dot{L}(\theta, \phi, \dot{\theta}, \dot{\phi}, t) = \frac{dL}{dt} = \frac{\partial L}{\partial \theta} \frac{d\theta}{dt} + \frac{\partial L}{\partial \phi} \frac{d\phi}{dt} + \frac{\partial L}{\partial \dot{\theta}} \frac{d\dot{\theta}}{dt} + \frac{\partial L}{\partial \dot{\phi}} \frac{d\dot{\phi}}{dt} + \frac{\partial L}{\partial t}$$

velocity chain

$$\dot{L}(\theta, \phi, \dot{\theta}, \dot{\phi}, t) = \frac{dL}{dt} = \dot{p}_{\theta} \frac{d\theta}{dt} + \dot{p}_{\phi} \frac{d\phi}{dt} + p_{\theta} \frac{d\dot{\theta}}{dt} + p_{\phi} \frac{d\dot{\phi}}{dt} + \frac{\partial L}{\partial t}$$

Lagrange equations

$$= \frac{dL}{dt} = \frac{d}{dt} (p_{\theta} \dot{\theta} + p_{\phi} \dot{\phi}) + \frac{\partial L}{\partial t}$$

(Consolidating)

$$\frac{d}{dt} (p_{\theta} \dot{\theta} + p_{\phi} \dot{\phi} - L) = -\frac{\partial L}{\partial t}$$

(Rearranging)

$$\frac{dH}{dt} = -\frac{\partial L}{\partial t}$$

Defining the Hamiltonian function

Hamiltonian function of GCC and momenta: $H(\theta, \phi, p_{\theta}, p_{\phi}, t) = p_{\theta} \dot{\theta} + p_{\phi} \dot{\phi} - L$

$$\frac{\partial H}{\partial \theta} = -\dot{p}_{\theta} \quad \frac{\partial H}{\partial p_{\theta}} = \dot{\theta} \quad \frac{\partial H}{\partial \dot{\theta}} = 0 \quad \frac{\partial H}{\partial \phi} = -\dot{p}_{\phi} \quad \frac{\partial H}{\partial p_{\phi}} = \dot{\phi} \quad \frac{\partial H}{\partial \dot{\phi}} = 0$$

by assumed Lagrange functionality

Hamilton's equations

by Lagrange equations

$$\text{Total KE} = T = \frac{1}{2} [M\dot{X}^2 + M\dot{Y}^2 + m\dot{x}^2 + m\dot{y}^2] = \frac{1}{2} [(MR^2 + mr^2)\dot{\theta}^2 - 2mrl \cos(\theta - \phi)\dot{\theta}\dot{\phi} + ml^2\dot{\phi}^2]$$

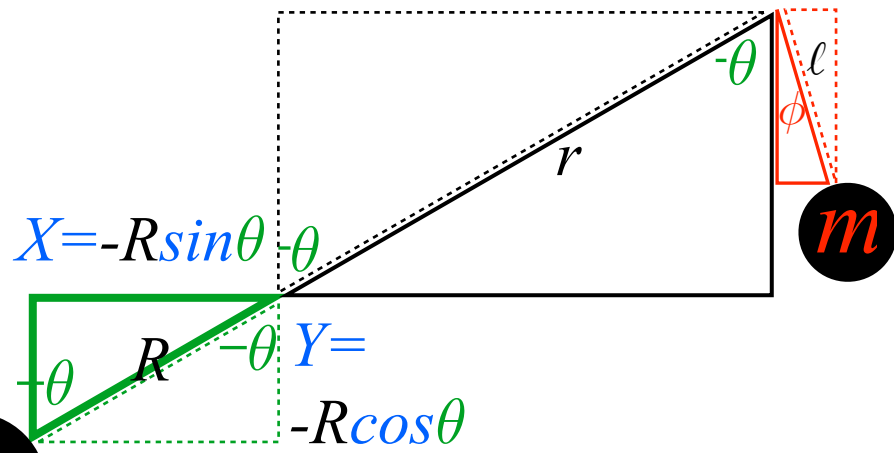

$$T = \frac{1}{2} \begin{pmatrix} \dot{\theta} & \dot{\phi} \end{pmatrix} \begin{pmatrix} MR^2 + mr^2 & -mrl \cos(\theta - \phi) \\ -mrl \cos(\theta - \phi) & ml^2 \end{pmatrix} \begin{pmatrix} \dot{\theta} \\ \dot{\phi} \end{pmatrix} = \frac{1}{2} \gamma_{mn} \dot{q}^m \dot{q}^n$$

$$\begin{pmatrix} p_\theta \\ p_\phi \end{pmatrix} = \begin{pmatrix} \gamma_{\theta,\theta} & \gamma_{\theta,\phi} \\ \gamma_{\phi,\theta} & \gamma_{\phi,\phi} \end{pmatrix} \begin{pmatrix} \dot{\theta} \\ \dot{\phi} \end{pmatrix}$$

Dynamic metric tensor
 γ_{mn}
in GCC θ and ϕ

Lagrangian function of GCC and velocities: $L(\theta, \phi, \dot{\theta}, \dot{\phi}, t) = T(\theta, \phi, \dot{\theta}, \dot{\phi}, t) - V(\theta, \phi, t)$

$$dL(\theta, \phi, \dot{\theta}, \dot{\phi}, t) = \frac{\partial L}{\partial \theta} d\theta + \frac{\partial L}{\partial \phi} d\phi + \frac{\partial L}{\partial \dot{\theta}} d\dot{\theta} + \frac{\partial L}{\partial \dot{\phi}} d\dot{\phi} + \frac{\partial L}{\partial t} dt$$

$$\dot{L}(\theta, \phi, \dot{\theta}, \dot{\phi}, t) = \frac{dL}{dt} = \frac{\partial L}{\partial \theta} \frac{d\theta}{dt} + \frac{\partial L}{\partial \phi} \frac{d\phi}{dt} + \frac{\partial L}{\partial \dot{\theta}} \frac{d\dot{\theta}}{dt} + \frac{\partial L}{\partial \dot{\phi}} \frac{d\dot{\phi}}{dt} + \frac{\partial L}{\partial t}$$

velocity chain

$$\dot{L}(\theta, \phi, \dot{\theta}, \dot{\phi}, t) = \frac{dL}{dt} = \dot{p}_\theta \frac{d\theta}{dt} + \dot{p}_\phi \frac{d\phi}{dt} + p_\theta \frac{d\dot{\theta}}{dt} + p_\phi \frac{d\dot{\phi}}{dt} + \frac{\partial L}{\partial t}$$

Lagrange equations

$$= \frac{dL}{dt} = \frac{d}{dt} (p_\theta \dot{\theta} + p_\phi \dot{\phi}) + \frac{\partial L}{\partial t}$$

(Consolidating)

$$\frac{d}{dt} (p_\theta \dot{\theta} + p_\phi \dot{\phi} - L) = -\frac{\partial L}{\partial t}$$

(Rearranging)

$$\frac{dH}{dt} = -\frac{\partial L}{\partial t}$$

Defining the Hamiltonian function

Hamiltonian function of GCC and momenta: $H(\theta, \phi, p_\theta, p_\phi, t) = p_\theta \dot{\theta} + p_\phi \dot{\phi} - L$ *Poincare-Legendre relation*

$$\frac{\partial H}{\partial \theta} = -\dot{p}_\theta \quad \frac{\partial H}{\partial p_\theta} = \dot{\theta} \quad \frac{\partial H}{\partial \dot{\theta}} \equiv 0$$

$$\frac{\partial H}{\partial \phi} = -\dot{p}_\phi \quad \frac{\partial H}{\partial p_\phi} = \dot{\phi} \quad \frac{\partial H}{\partial \dot{\phi}} \equiv 0$$

Hamilton's equations

Review of Hamiltonian equation derivation (Elementary trebuchet)
Hamiltonian definition from Lagrangian and γ_{mn} tensor
Hamilton's equations and Poincare invariant relations
 *Hamiltonian expression and contravariant γ^{mn} tensor*

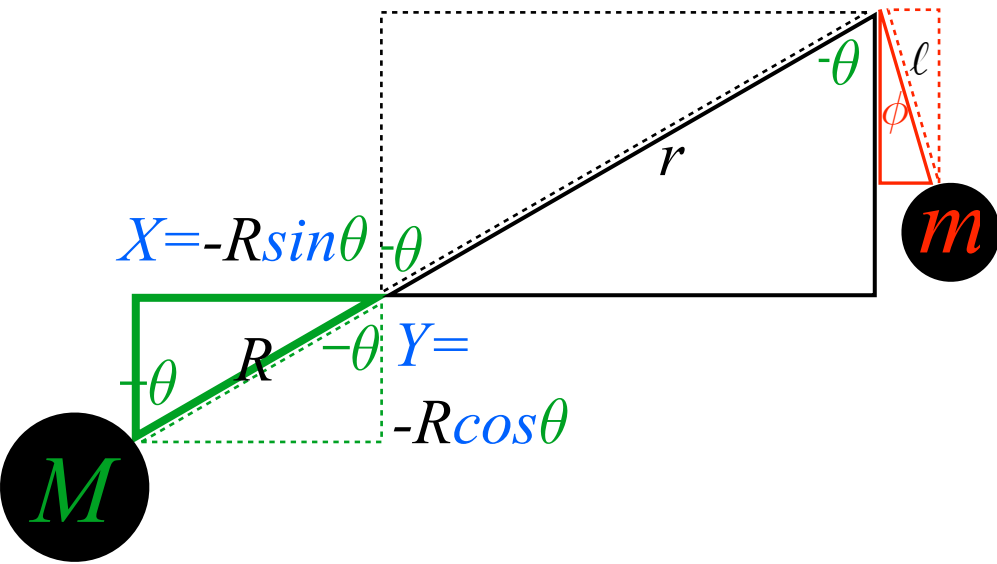

$$\text{Total KE} = T = \frac{1}{2} [M\dot{X}^2 + M\dot{Y}^2 + m\dot{x}^2 + m\dot{y}^2] = \frac{1}{2} [(MR^2 + mr^2)\dot{\theta}^2 - 2mrl \cos(\theta - \phi)\dot{\theta}\dot{\phi} + ml^2\dot{\phi}^2]$$

$$T = \frac{1}{2} \begin{pmatrix} \dot{\theta} & \dot{\phi} \end{pmatrix} \begin{pmatrix} MR^2 + mr^2 & -mrl \cos(\theta - \phi) \\ -mrl \cos(\theta - \phi) & ml^2 \end{pmatrix} \begin{pmatrix} \dot{\theta} \\ \dot{\phi} \end{pmatrix} = \frac{1}{2} \gamma_{mn} \dot{q}^m \dot{q}^n$$

$$\begin{pmatrix} p_{\theta} \\ p_{\phi} \end{pmatrix} = \begin{pmatrix} \gamma_{\theta\theta} & \gamma_{\theta\phi} \\ \gamma_{\phi\theta} & \gamma_{\phi\phi} \end{pmatrix} \begin{pmatrix} \dot{\theta} \\ \dot{\phi} \end{pmatrix} \quad \text{Covariant metric tensor} \quad \gamma_{mn}$$

$$\begin{pmatrix} \dot{\theta} \\ \dot{\phi} \end{pmatrix} = \begin{pmatrix} \gamma^{\theta\theta} & \gamma^{\theta\phi} \\ \gamma^{\phi\theta} & \gamma^{\phi\phi} \end{pmatrix} \begin{pmatrix} p_{\theta} \\ p_{\phi} \end{pmatrix} \quad \text{Contravariant metric tensor} \quad \gamma^{mn}$$

$$T = \frac{1}{2} \begin{pmatrix} p_{\theta} & p_{\phi} \end{pmatrix} \begin{pmatrix} ml^2 & mrl \cos(\theta - \phi) \\ mrl \cos(\theta - \phi) & MR^2 + mr^2 \end{pmatrix} \begin{pmatrix} p_{\theta} \\ p_{\phi} \end{pmatrix} = \frac{1}{2} \gamma^{mn} p_m p_n$$

Lagrangian function of GCC and velocities: $L(\theta, \phi, \dot{\theta}, \dot{\phi}, t) = T(\theta, \phi, \dot{\theta}, \dot{\phi}, t) - V(\theta, \phi, t)$

Hamiltonian function of GCC and momenta: $H(\theta, \phi, p_{\theta}, p_{\phi}, t) = p_{\theta}\dot{\theta} + p_{\phi}\dot{\phi} - L$ *Poincare-Legendre relation*

$$H = p_{\theta}\dot{\theta} + p_{\phi}\dot{\phi} - T + V$$

$$H = (\gamma_{\theta\theta}\dot{\theta} + \gamma_{\theta\phi}\dot{\phi})\dot{\theta} + (\gamma_{\phi\theta}\dot{\theta} + \gamma_{\phi\phi}\dot{\phi})\dot{\phi} - \frac{1}{2}(\gamma_{\theta\theta}\dot{\theta}\dot{\theta} + \gamma_{\theta\phi}\dot{\theta}\dot{\phi} + \gamma_{\phi\theta}\dot{\theta}\dot{\phi} + \gamma_{\phi\phi}\dot{\phi}\dot{\phi}) + V$$

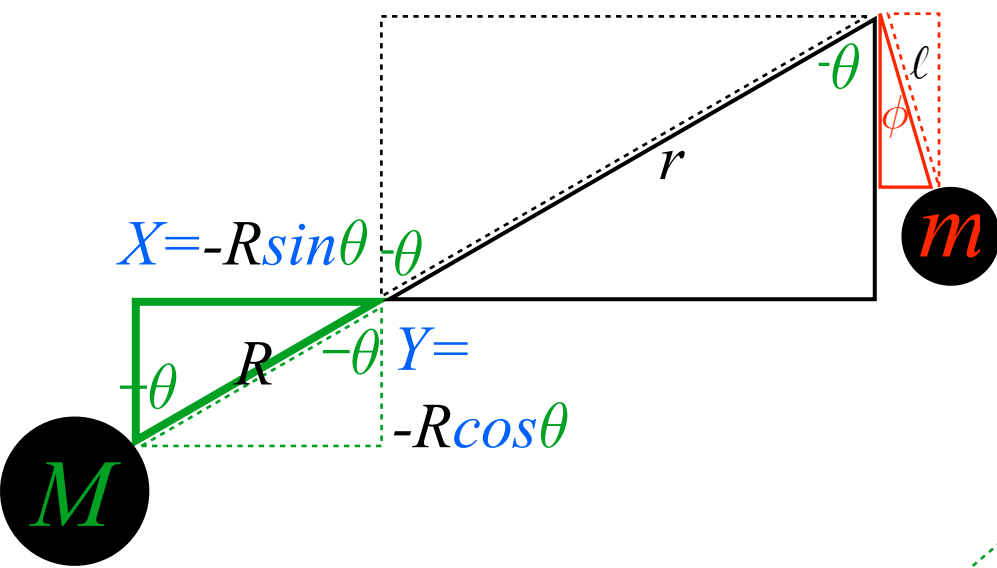

$$\text{Total KE} = T = \frac{1}{2} [M\dot{X}^2 + M\dot{Y}^2 + m\dot{x}^2 + m\dot{y}^2] = \frac{1}{2} [(MR^2 + mr^2)\dot{\theta}^2 - 2mrl \cos(\theta - \phi)\dot{\theta}\dot{\phi} + ml^2\dot{\phi}^2]$$

$$T = \frac{1}{2} \begin{pmatrix} \dot{\theta} & \dot{\phi} \end{pmatrix} \begin{pmatrix} MR^2 + mr^2 & -mrl \cos(\theta - \phi) \\ -mrl \cos(\theta - \phi) & ml^2 \end{pmatrix} \begin{pmatrix} \dot{\theta} \\ \dot{\phi} \end{pmatrix} = \frac{1}{2} \gamma_{mn} \dot{q}^m \dot{q}^n$$

$$\begin{pmatrix} p_{\theta} \\ p_{\phi} \end{pmatrix} = \begin{pmatrix} \gamma_{\theta\theta} & \gamma_{\theta\phi} \\ \gamma_{\phi\theta} & \gamma_{\phi\phi} \end{pmatrix} \begin{pmatrix} \dot{\theta} \\ \dot{\phi} \end{pmatrix} \quad \text{Covariant metric tensor} \quad \gamma_{mn}$$

$$\begin{pmatrix} \dot{\theta} \\ \dot{\phi} \end{pmatrix} = \begin{pmatrix} \gamma^{\theta\theta} & \gamma^{\theta\phi} \\ \gamma^{\phi\theta} & \gamma^{\phi\phi} \end{pmatrix} \begin{pmatrix} p_{\theta} \\ p_{\phi} \end{pmatrix} \quad \text{Contravariant metric tensor} \quad \gamma^{mn}$$

$$T = \frac{1}{2} \begin{pmatrix} p_{\theta} & p_{\phi} \end{pmatrix} \begin{pmatrix} ml^2 & mrl \cos(\theta - \phi) \\ mrl \cos(\theta - \phi) & MR^2 + mr^2 \end{pmatrix} \begin{pmatrix} p_{\theta} \\ p_{\phi} \end{pmatrix} = \frac{1}{2} \gamma^{mn} p_m p_n$$

Lagrangian function of GCC and velocities: $L(\theta, \phi, \dot{\theta}, \dot{\phi}, t) = T(\theta, \phi, \dot{\theta}, \dot{\phi}, t) - V(\theta, \phi, t)$

Hamiltonian function of GCC and momenta: $H(\theta, \phi, p_{\theta}, p_{\phi}, t) = p_{\theta}\dot{\theta} + p_{\phi}\dot{\phi} - L$ *Poincare-Legendre relation*

$$H = p_{\theta}\dot{\theta} + p_{\phi}\dot{\phi} - T + V$$

$$H = (\gamma_{\theta\theta}\dot{\theta} + \gamma_{\theta\phi}\dot{\phi})\dot{\theta} + (\gamma_{\phi\theta}\dot{\theta} + \gamma_{\phi\phi}\dot{\phi})\dot{\phi} - \frac{1}{2}(\gamma_{\theta\theta}\dot{\theta}\dot{\theta} + \gamma_{\theta\phi}\dot{\phi}\dot{\theta} + \gamma_{\phi\theta}\dot{\theta}\dot{\phi} + \gamma_{\phi\phi}\dot{\phi}\dot{\phi}) + V$$

$$H = \frac{1}{2}(\gamma_{\theta\theta}\dot{\theta}\dot{\theta} + \gamma_{\theta\phi}\dot{\phi}\dot{\theta} + \gamma_{\phi\theta}\dot{\theta}\dot{\phi} + \gamma_{\phi\phi}\dot{\phi}\dot{\phi}) + V = T + V \quad (\text{Only correct numerically!})$$

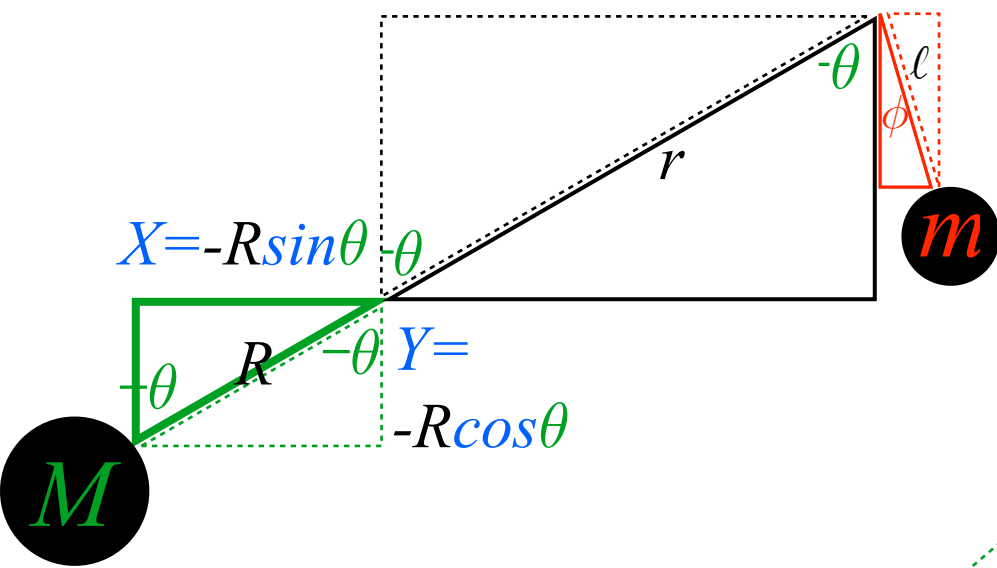

$$\text{Total KE} = T = \frac{1}{2} [M\dot{X}^2 + M\dot{Y}^2 + m\dot{x}^2 + m\dot{y}^2] = \frac{1}{2} [(MR^2 + mr^2)\dot{\theta}^2 - 2mrl \cos(\theta - \phi)\dot{\theta}\dot{\phi} + ml^2\dot{\phi}^2]$$

$$T = \frac{1}{2} \begin{pmatrix} \dot{\theta} & \dot{\phi} \end{pmatrix} \begin{pmatrix} MR^2 + mr^2 & -mrl \cos(\theta - \phi) \\ -mrl \cos(\theta - \phi) & ml^2 \end{pmatrix} \begin{pmatrix} \dot{\theta} \\ \dot{\phi} \end{pmatrix} = \frac{1}{2} \gamma_{mn} \dot{q}^m \dot{q}^n$$

$$\begin{pmatrix} p_{\theta} \\ p_{\phi} \end{pmatrix} = \begin{pmatrix} \gamma_{\theta\theta} & \gamma_{\theta\phi} \\ \gamma_{\phi\theta} & \gamma_{\phi\phi} \end{pmatrix} \begin{pmatrix} \dot{\theta} \\ \dot{\phi} \end{pmatrix} \quad \text{Covariant metric tensor } \gamma_{mn}$$

$$\begin{pmatrix} \dot{\theta} \\ \dot{\phi} \end{pmatrix} = \begin{pmatrix} \gamma^{\theta\theta} & \gamma^{\theta\phi} \\ \gamma^{\phi\theta} & \gamma^{\phi\phi} \end{pmatrix} \begin{pmatrix} p_{\theta} \\ p_{\phi} \end{pmatrix} \quad \text{Contravariant metric tensor } \gamma^{mn}$$

$$T = \frac{1}{2} \begin{pmatrix} p_{\theta} & p_{\phi} \end{pmatrix} \begin{pmatrix} ml^2 & mrl \cos(\theta - \phi) \\ mrl \cos(\theta - \phi) & MR^2 + mr^2 \end{pmatrix} \begin{pmatrix} p_{\theta} \\ p_{\phi} \end{pmatrix} = \frac{1}{2} \gamma^{mn} p_m p_n$$

Lagrangian function of GCC and velocities: $L(\theta, \phi, \dot{\theta}, \dot{\phi}, t) = T(\theta, \phi, \dot{\theta}, \dot{\phi}, t) - V(\theta, \phi, t)$

Hamiltonian function of GCC and momenta: $H(\theta, \phi, p_{\theta}, p_{\phi}, t) = p_{\theta}\dot{\theta} + p_{\phi}\dot{\phi} - L$ *Poincare-Legendre relation*

$$H = p_{\theta}\dot{\theta} + p_{\phi}\dot{\phi} - T + V$$

$$H = (\gamma_{\theta\theta}\dot{\theta} + \gamma_{\theta\phi}\dot{\phi})\dot{\theta} + (\gamma_{\phi\theta}\dot{\theta} + \gamma_{\phi\phi}\dot{\phi})\dot{\phi} - \frac{1}{2}(\gamma_{\theta\theta}\dot{\theta}\dot{\theta} + \gamma_{\theta\phi}\dot{\phi}\dot{\theta} + \gamma_{\phi\theta}\dot{\theta}\dot{\phi} + \gamma_{\phi\phi}\dot{\phi}\dot{\phi}) + V$$

$$H = \frac{1}{2}(\gamma_{\theta\theta}\dot{\theta}\dot{\theta} + \gamma_{\theta\phi}\dot{\phi}\dot{\theta} + \gamma_{\phi\theta}\dot{\theta}\dot{\phi} + \gamma_{\phi\phi}\dot{\phi}\dot{\phi}) + V = T + V \equiv E \quad (\text{Only correct numerically!})$$

Hamiltonian must be explicit in momenta p_m

$$\text{Total KE} = T = \frac{1}{2} [M\dot{X}^2 + M\dot{Y}^2 + m\dot{x}^2 + m\dot{y}^2] = \frac{1}{2} [(MR^2 + mr^2)\dot{\theta}^2 - 2mrl \cos(\theta - \phi)\dot{\theta}\dot{\phi} + ml^2\dot{\phi}^2]$$

$$T = \frac{1}{2} \begin{pmatrix} \dot{\theta} & \dot{\phi} \end{pmatrix} \begin{pmatrix} MR^2 + mr^2 & -mrl \cos(\theta - \phi) \\ -mrl \cos(\theta - \phi) & ml^2 \end{pmatrix} \begin{pmatrix} \dot{\theta} \\ \dot{\phi} \end{pmatrix} = \frac{1}{2} \gamma_{mn} \dot{q}^m \dot{q}^n$$

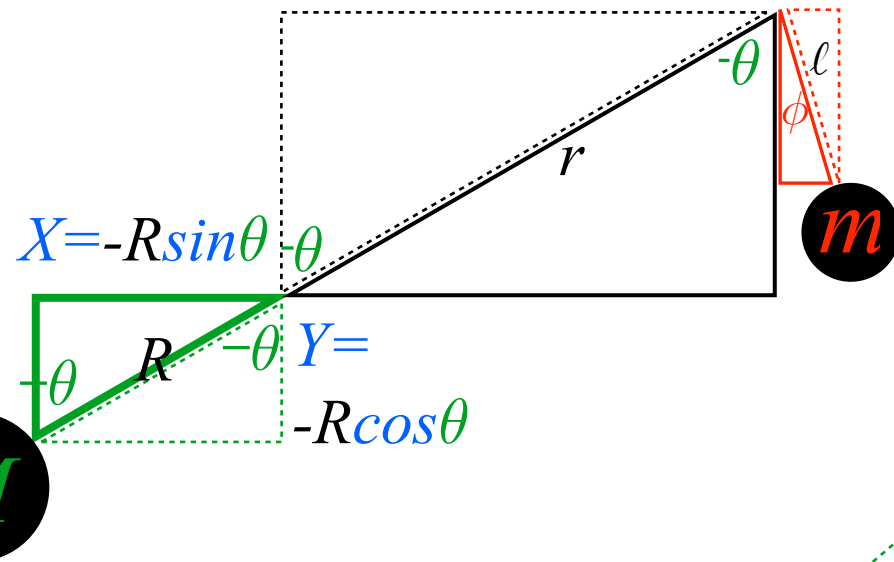

$$\begin{pmatrix} p_\theta \\ p_\phi \end{pmatrix} = \begin{pmatrix} \gamma_{\theta\theta} & \gamma_{\theta\phi} \\ \gamma_{\phi\theta} & \gamma_{\phi\phi} \end{pmatrix} \begin{pmatrix} \dot{\theta} \\ \dot{\phi} \end{pmatrix} \quad \text{Covariant metric tensor} \quad \gamma_{mn}$$

$$\begin{pmatrix} \dot{\theta} \\ \dot{\phi} \end{pmatrix} = \begin{pmatrix} \gamma^{\theta\theta} & \gamma^{\theta\phi} \\ \gamma^{\phi\theta} & \gamma^{\phi\phi} \end{pmatrix} \begin{pmatrix} p_\theta \\ p_\phi \end{pmatrix} \quad \text{Contravariant metric tensor} \quad \gamma^{mn}$$

$$T = \frac{1}{2} \begin{pmatrix} p_\theta & p_\phi \end{pmatrix} \begin{pmatrix} ml^2 & mrl \cos(\theta - \phi) \\ mrl \cos(\theta - \phi) & MR^2 + mr^2 \end{pmatrix} \begin{pmatrix} p_\theta \\ p_\phi \end{pmatrix} = \frac{1}{2} \gamma^{mn} p_m p_n$$

Lagrangian function of GCC and velocities: $L(\theta, \phi, \dot{\theta}, \dot{\phi}, t) = T(\theta, \phi, \dot{\theta}, \dot{\phi}, t) - V(\theta, \phi, t)$

Hamiltonian function of GCC and momenta: $H(\theta, \phi, p_\theta, p_\phi, t) = p_\theta \dot{\theta} + p_\phi \dot{\phi} - L$ *Poincare-Legendre relation*

$$H = p_\theta \dot{\theta} + p_\phi \dot{\phi} - T + V$$

$$H = (\gamma_{\theta\theta} \dot{\theta} + \gamma_{\theta\phi} \dot{\phi}) \dot{\theta} + (\gamma_{\phi\theta} \dot{\theta} + \gamma_{\phi\phi} \dot{\phi}) \dot{\phi} - \frac{1}{2} (\gamma_{\theta\theta} \dot{\theta} \dot{\theta} + \gamma_{\theta\phi} \dot{\theta} \dot{\phi} + \gamma_{\phi\theta} \dot{\theta} \dot{\phi} + \gamma_{\phi\phi} \dot{\phi} \dot{\phi}) + V$$

$$H = \frac{1}{2} (\gamma_{\theta\theta} \dot{\theta} \dot{\theta} + \gamma_{\theta\phi} \dot{\theta} \dot{\phi} + \gamma_{\phi\theta} \dot{\theta} \dot{\phi} + \gamma_{\phi\phi} \dot{\phi} \dot{\phi}) + V = T + V \equiv E \quad (\text{Only correct numerically!})$$

$$H = \frac{1}{2} (\gamma^{\theta\theta} p_\theta p_\theta + \gamma^{\theta\phi} p_\theta p_\phi + \gamma^{\phi\theta} p_\phi p_\theta + \gamma^{\phi\phi} p_\phi p_\phi) + V = T + V \quad (\text{Correct formally and numerically!})$$

Hamiltonian must be explicit in momenta p_m

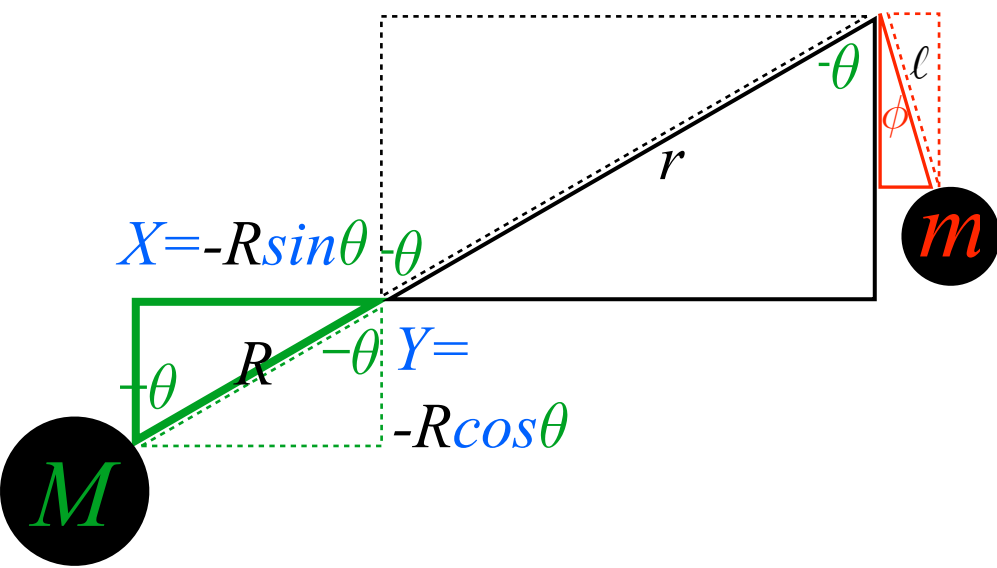

$$\text{Total KE} = T = \frac{1}{2} [M\dot{X}^2 + M\dot{Y}^2 + m\dot{x}^2 + m\dot{y}^2] = \frac{1}{2} [(MR^2 + mr^2)\dot{\theta}^2 - 2mr\ell \cos(\theta - \phi)\dot{\theta}\dot{\phi} + m\ell^2\dot{\phi}^2]$$

$$T = \frac{1}{2} \begin{pmatrix} \dot{\theta} & \dot{\phi} \end{pmatrix} \begin{pmatrix} MR^2 + mr^2 & -mr\ell \cos(\theta - \phi) \\ -mr\ell \cos(\theta - \phi) & m\ell^2 \end{pmatrix} \begin{pmatrix} \dot{\theta} \\ \dot{\phi} \end{pmatrix} = \frac{1}{2} \gamma_{mn} \dot{q}^m \dot{q}^n$$

$$\begin{pmatrix} p_\theta \\ p_\phi \end{pmatrix} = \begin{pmatrix} \gamma_{\theta\theta} & \gamma_{\theta\phi} \\ \gamma_{\phi\theta} & \gamma_{\phi\phi} \end{pmatrix} \begin{pmatrix} \dot{\theta} \\ \dot{\phi} \end{pmatrix} \quad \text{Covariant metric tensor} \quad \gamma_{mn}$$

$$\begin{pmatrix} \dot{\theta} \\ \dot{\phi} \end{pmatrix} = \begin{pmatrix} \gamma^{\theta\theta} & \gamma^{\theta\phi} \\ \gamma^{\phi\theta} & \gamma^{\phi\phi} \end{pmatrix} \begin{pmatrix} p_\theta \\ p_\phi \end{pmatrix} \quad \text{Contravariant metric tensor} \quad \gamma^{mn}$$

$$T = \frac{1}{2} \begin{pmatrix} p_\theta & p_\phi \end{pmatrix} \begin{pmatrix} m\ell^2 & mr\ell \cos(\theta - \phi) \\ mr\ell \cos(\theta - \phi) & MR^2 + mr^2 \end{pmatrix} \begin{pmatrix} p_\theta \\ p_\phi \end{pmatrix} = \frac{1}{2} \gamma^{mn} p_m p_n$$

Lagrangian function of GCC and velocities: $L(\theta, \phi, \dot{\theta}, \dot{\phi}, t) = T(\theta, \phi, \dot{\theta}, \dot{\phi}, t) - V(\theta, \phi, t)$

Hamiltonian function of GCC and momenta: $H(\theta, \phi, p_\theta, p_\phi, t) = p_\theta \dot{\theta} + p_\phi \dot{\phi} - L$ *Poincare-Legendre relation*

$$H = p_\theta \dot{\theta} + p_\phi \dot{\phi} - T + V$$

$$H = (\gamma_{\theta\theta} \dot{\theta} + \gamma_{\theta\phi} \dot{\phi}) \dot{\theta} + (\gamma_{\phi\theta} \dot{\theta} + \gamma_{\phi\phi} \dot{\phi}) \dot{\phi} - \frac{1}{2} (\gamma_{\theta\theta} \dot{\theta} \dot{\theta} + \gamma_{\theta\phi} \dot{\theta} \dot{\phi} + \gamma_{\phi\theta} \dot{\theta} \dot{\phi} + \gamma_{\phi\phi} \dot{\phi} \dot{\phi}) + V$$

$$H = \frac{1}{2} (\gamma_{\theta\theta} \dot{\theta} \dot{\theta} + \gamma_{\theta\phi} \dot{\theta} \dot{\phi} + \gamma_{\phi\theta} \dot{\theta} \dot{\phi} + \gamma_{\phi\phi} \dot{\phi} \dot{\phi}) + V = T + V \equiv E \quad (\text{Only correct numerically!})$$

$$H = \frac{1}{2} (\gamma^{\theta\theta} p_\theta p_\theta + \gamma^{\theta\phi} p_\theta p_\phi + \gamma^{\phi\theta} p_\phi p_\theta + \gamma^{\phi\phi} p_\phi p_\phi) + V = T + V \quad (\text{Correct formally and numerically})$$

$$H = \frac{m\ell^2 p_\theta p_\theta + 2mr\ell \cos(\theta - \phi) p_\theta p_\phi + (MR^2 + mr^2) p_\phi p_\phi}{2m\ell^2 [MR^2 + mr^2 \sin^2(\theta - \phi)]} + V$$

Hamiltonian must be explicit in momenta p_m

Hamilton equations for elementary trebuchet

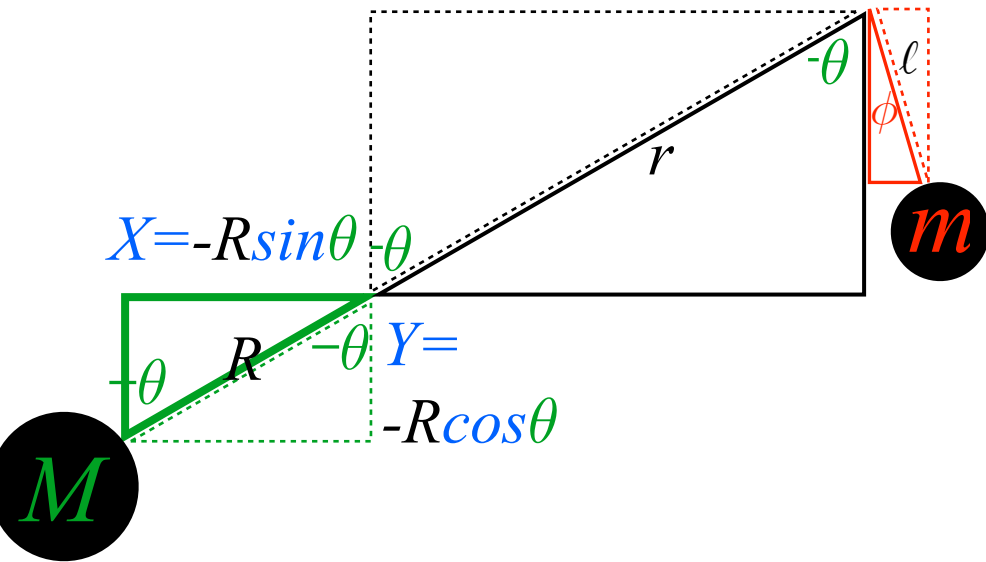

$$\begin{pmatrix} \dot{\theta} \\ \dot{\phi} \end{pmatrix} = \begin{pmatrix} \gamma^{\theta\theta} & \gamma^{\theta\phi} \\ \gamma^{\phi\theta} & \gamma^{\phi\phi} \end{pmatrix} \begin{pmatrix} p_{\theta} \\ p_{\phi} \end{pmatrix} \quad \text{Contravariant metric tensor}$$

$$T = \frac{1}{2} \begin{pmatrix} p_{\theta} & p_{\phi} \end{pmatrix} \begin{pmatrix} m\ell^2 & mrl \cos(\theta - \phi) \\ mrl \cos(\theta - \phi) & MR^2 + mr^2 \end{pmatrix} \begin{pmatrix} p_{\theta} \\ p_{\phi} \end{pmatrix} = \frac{1}{2} \gamma^{mn} p_m p_n$$

$$\begin{aligned} \dot{\theta} &= \gamma^{\theta\theta} p_{\theta} + \gamma^{\theta\phi} p_{\phi} \\ \dot{\phi} &= \gamma^{\phi\theta} p_{\theta} + \gamma^{\phi\phi} p_{\phi} \end{aligned}$$

$$\begin{aligned} p_{\theta} &= \gamma_{\theta\theta} \dot{\theta} + \gamma_{\theta\phi} \dot{\phi} \\ p_{\phi} &= \gamma_{\phi\theta} \dot{\theta} + \gamma_{\phi\phi} \dot{\phi} \end{aligned}$$

Coordinate equations

$$\frac{\partial H}{\partial p_{\theta}} = \dot{\theta} = \gamma^{\phi\theta} p_{\theta} + \gamma^{\phi\phi} p_{\phi}$$

$$\frac{\partial H}{\partial p_{\phi}} = \dot{\phi} = \gamma^{\theta\theta} p_{\theta} + \gamma^{\theta\phi} p_{\phi}$$

Hamilton equations for elementary trebuchet

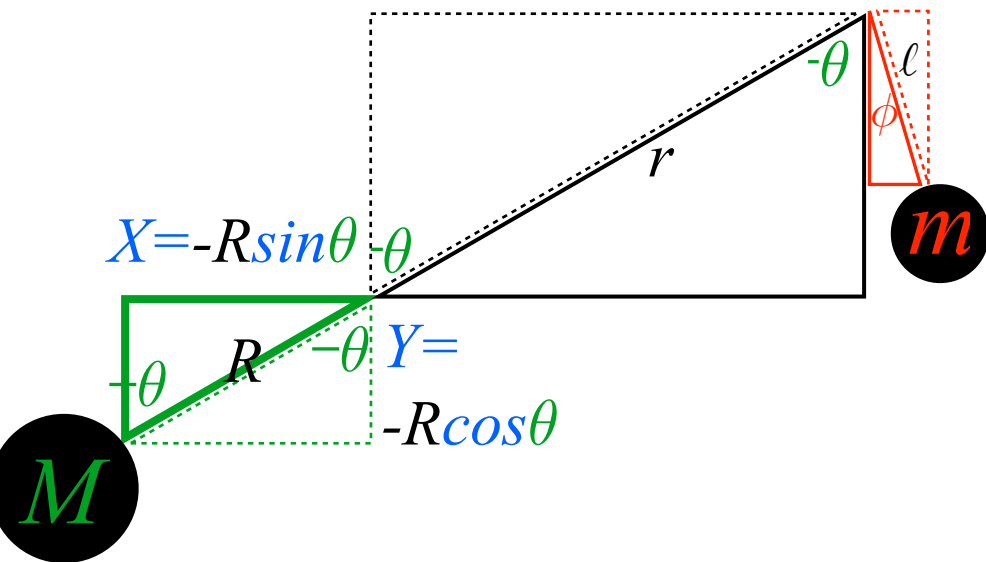

$$\begin{pmatrix} \dot{\theta} \\ \dot{\phi} \end{pmatrix} = \begin{pmatrix} \gamma^{\theta\theta} & \gamma^{\theta\phi} \\ \gamma^{\phi\theta} & \gamma^{\phi\phi} \end{pmatrix} \begin{pmatrix} p_\theta \\ p_\phi \end{pmatrix} \quad \text{Contravariant metric tensor}$$

$$T = \frac{1}{2} \begin{pmatrix} p_\theta & p_\phi \end{pmatrix} \begin{pmatrix} ml^2 & mrl \cos(\theta - \phi) \\ mrl \cos(\theta - \phi) & MR^2 + mr^2 \end{pmatrix} \begin{pmatrix} p_\theta \\ p_\phi \end{pmatrix} = \frac{1}{2} \gamma^{mn} p_m p_n$$

$$\begin{aligned} \dot{\theta} &= \gamma^{\theta\theta} p_\theta + \gamma^{\theta\phi} p_\phi \\ \dot{\phi} &= \gamma^{\phi\theta} p_\theta + \gamma^{\phi\phi} p_\phi \end{aligned}$$

$$\begin{aligned} p_\theta &= \gamma_{\theta\theta} \dot{\theta} + \gamma_{\theta\phi} \dot{\phi} \\ p_\phi &= \gamma_{\phi\theta} \dot{\theta} + \gamma_{\phi\phi} \dot{\phi} \end{aligned}$$

Coordinate equations

$$\frac{\partial H}{\partial p_\theta} = \dot{\theta} = \gamma^{\phi\theta} p_\theta + \gamma^{\phi\phi} p_\phi$$

$$\frac{\partial H}{\partial p_\phi} = \dot{\phi} = \gamma^{\theta\theta} p_\theta + \gamma^{\theta\phi} p_\phi$$

Momentum/force equations

$$\begin{aligned} \dot{p}_\theta &= -\frac{\partial H}{\partial \theta} = \frac{\partial L}{\partial \theta} = \frac{\partial T}{\partial \theta} - \frac{\partial V}{\partial \theta} \\ &= mr\ell \dot{\theta} \dot{\phi} \sin(\theta - \phi) + F_\theta \end{aligned}$$

(May just use Lagrange results...
...but to be formally correct...
...must convert contra-velocities
to covariant momenta!)

$$\begin{aligned} \dot{p}_\phi &= -\frac{\partial H}{\partial \phi} = \frac{\partial L}{\partial \phi} = \frac{\partial T}{\partial \phi} - \frac{\partial V}{\partial \phi} \\ &= -mr\ell \dot{\theta} \dot{\phi} \sin(\theta - \phi) + F_\phi \end{aligned}$$

Hamilton equations for elementary trebuchet

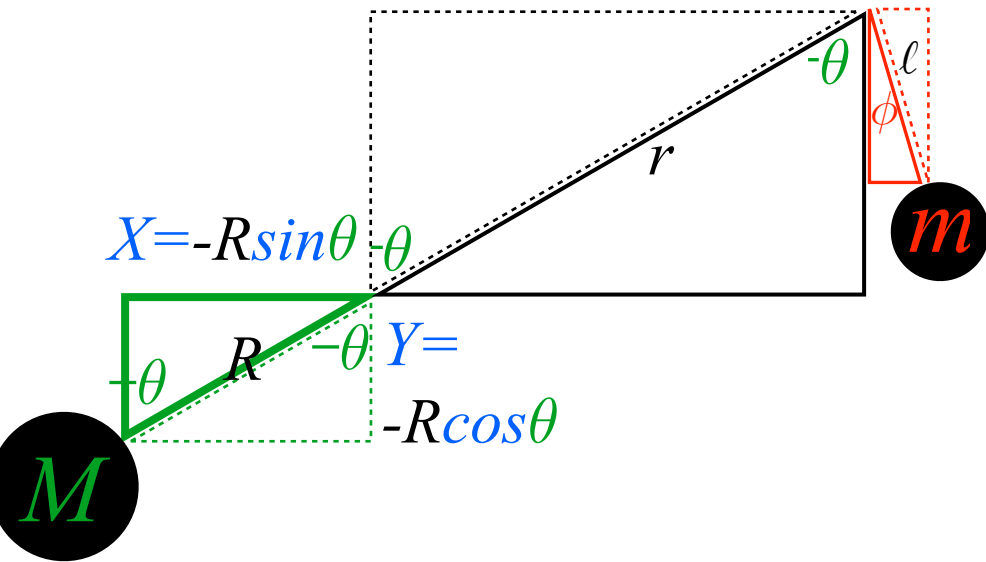

$$\begin{pmatrix} \dot{\theta} \\ \dot{\phi} \end{pmatrix} = \begin{pmatrix} \gamma^{\theta\theta} & \gamma^{\theta\phi} \\ \gamma^{\phi\theta} & \gamma^{\phi\phi} \end{pmatrix} \begin{pmatrix} p_{\theta} \\ p_{\phi} \end{pmatrix} \quad \text{Contravariant metric tensor}$$

$$T = \frac{1}{2} \begin{pmatrix} p_{\theta} & p_{\phi} \end{pmatrix} \begin{pmatrix} m\ell^2 & mr\ell \cos(\theta - \phi) \\ mr\ell \cos(\theta - \phi) & MR^2 + mr^2 \end{pmatrix} \begin{pmatrix} p_{\theta} \\ p_{\phi} \end{pmatrix} = \frac{1}{2} \gamma^{mn} p_m p_n$$

$$\begin{aligned} \dot{\theta} &= \gamma^{\theta\theta} p_{\theta} + \gamma^{\theta\phi} p_{\phi} \\ \dot{\phi} &= \gamma^{\phi\theta} p_{\theta} + \gamma^{\phi\phi} p_{\phi} \end{aligned}$$

$$\begin{aligned} p_{\theta} &= \gamma_{\theta\theta} \dot{\theta} + \gamma_{\theta\phi} \dot{\phi} \\ p_{\phi} &= \gamma_{\phi\theta} \dot{\theta} + \gamma_{\phi\phi} \dot{\phi} \end{aligned}$$

Coordinate equations

$$\frac{\partial H}{\partial p_{\theta}} = \dot{\theta} = \gamma^{\phi\theta} p_{\theta} + \gamma^{\phi\phi} p_{\phi}$$

$$\frac{\partial H}{\partial p_{\phi}} = \dot{\phi} = \gamma^{\theta\theta} p_{\theta} + \gamma^{\theta\phi} p_{\phi}$$

Momentum/force equations

$$\begin{aligned} \dot{p}_{\theta} &= -\frac{\partial H}{\partial \theta} = \frac{\partial L}{\partial \theta} = \frac{\partial T}{\partial \theta} - \frac{\partial V}{\partial \theta} \quad (\text{May just use Lagrange results...}) \\ &= mr\ell \dot{\theta} \dot{\phi} \sin(\theta - \phi) + F_{\theta} \quad (\text{...but to be formally correct...}) \\ &= mr\ell (\gamma^{\theta\theta} p_{\theta} + \gamma^{\theta\phi} p_{\phi}) (\gamma^{\phi\theta} p_{\theta} + \gamma^{\phi\phi} p_{\phi}) \sin(\theta - \phi) + F_{\theta} \quad (\text{...must convert contra-velocities to covariant momenta!}) \end{aligned}$$

$$\begin{aligned} \dot{p}_{\phi} &= -\frac{\partial H}{\partial \phi} = \frac{\partial L}{\partial \phi} = \frac{\partial T}{\partial \phi} - \frac{\partial V}{\partial \phi} \\ &= -mr\ell \dot{\theta} \dot{\phi} \sin(\theta - \phi) + F_{\phi} \\ &= -mr\ell (\gamma^{\theta\theta} p_{\theta} + \gamma^{\theta\phi} p_{\phi}) (\gamma^{\phi\theta} p_{\theta} + \gamma^{\phi\phi} p_{\phi}) \sin(\theta - \phi) + F_{\phi} \end{aligned}$$

Hamilton equations for elementary trebuchet

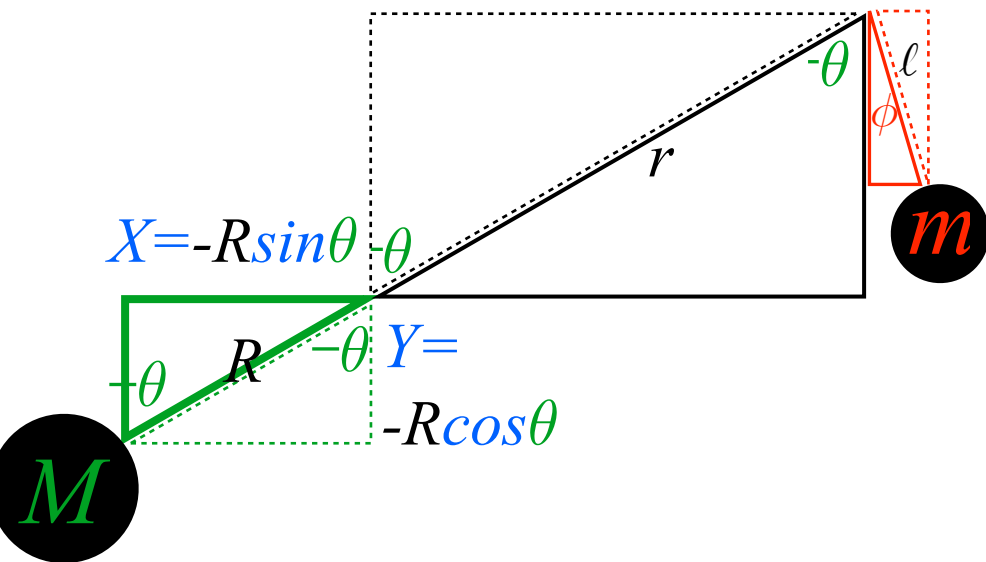

$$\begin{pmatrix} \dot{\theta} \\ \dot{\phi} \end{pmatrix} = \begin{pmatrix} \gamma^{\theta\theta} & \gamma^{\theta\phi} \\ \gamma^{\phi\theta} & \gamma^{\phi\phi} \end{pmatrix} \begin{pmatrix} p_\theta \\ p_\phi \end{pmatrix} \quad \text{Contravariant metric tensor } \gamma^{mn}$$

$$T = \frac{1}{2} \begin{pmatrix} p_\theta & p_\phi \end{pmatrix} \begin{pmatrix} m\ell^2 & mr\ell \cos(\theta - \phi) \\ mr\ell \cos(\theta - \phi) & MR^2 + mr^2 \end{pmatrix} \begin{pmatrix} p_\theta \\ p_\phi \end{pmatrix} = \frac{1}{2} \gamma^{mn} p_m p_n$$

$$m\ell^2 [MR^2 + mr^2 \sin^2(\theta - \phi)]$$

$$\begin{aligned} \dot{\theta} &= \gamma^{\theta\theta} p_\theta + \gamma^{\theta\phi} p_\phi \\ \dot{\phi} &= \gamma^{\phi\theta} p_\theta + \gamma^{\phi\phi} p_\phi \end{aligned}$$

$$\begin{aligned} p_\theta &= \gamma_{\theta\theta} \dot{\theta} + \gamma_{\theta\phi} \dot{\phi} \\ p_\phi &= \gamma_{\phi\theta} \dot{\theta} + \gamma_{\phi\phi} \dot{\phi} \end{aligned}$$

Coordinate equations

$$\frac{\partial H}{\partial p_\theta} = \dot{\theta} = \gamma^{\phi\theta} p_\theta + \gamma^{\phi\phi} p_\phi$$

$$\frac{\partial H}{\partial p_\phi} = \dot{\phi} = \gamma^{\theta\theta} p_\theta + \gamma^{\theta\phi} p_\phi$$

Momentum/force equations

$$\dot{p}_\theta = -\frac{\partial H}{\partial \theta} = \frac{\partial L}{\partial \theta} = \frac{\partial T}{\partial \theta} - \frac{\partial V}{\partial \theta} \quad \text{(May just use Lagrange results... but to be formally correct... must convert contra-velocities to covariant momenta!)}$$

$$= mr\ell \dot{\theta} \dot{\phi} \sin(\theta - \phi) + F_\theta$$

$$\dot{p}_\phi = -\frac{\partial H}{\partial \phi} = \frac{\partial L}{\partial \phi} = \frac{\partial T}{\partial \phi} - \frac{\partial V}{\partial \phi}$$

$$= -mr\ell \dot{\theta} \dot{\phi} \sin(\theta - \phi) + F_\phi$$

$$= mr\ell (\gamma^{\theta\theta} p_\theta + \gamma^{\theta\phi} p_\phi) (\gamma^{\phi\theta} p_\theta + \gamma^{\phi\phi} p_\phi) \sin(\theta - \phi) + F_\theta$$

$$= mr\ell (\gamma^{\theta\theta} \gamma^{\phi\theta} p_\theta^2 + [\gamma^{\theta\theta} \gamma^{\phi\phi} + (\gamma^{\theta\phi})^2] p_\phi p_\theta + \gamma^{\theta\phi} \gamma^{\phi\phi} p_\phi^2) \sin(\theta - \phi) + F_\theta$$

$$= -mr\ell (\gamma^{\theta\theta} p_\theta + \gamma^{\theta\phi} p_\phi) (\gamma^{\phi\theta} p_\theta + \gamma^{\phi\phi} p_\phi) \sin(\theta - \phi) + F_\phi$$

$$= -[\text{messy factor}] \sin(\theta - \phi) + F_\phi$$

Hamilton equations for elementary trebuchet

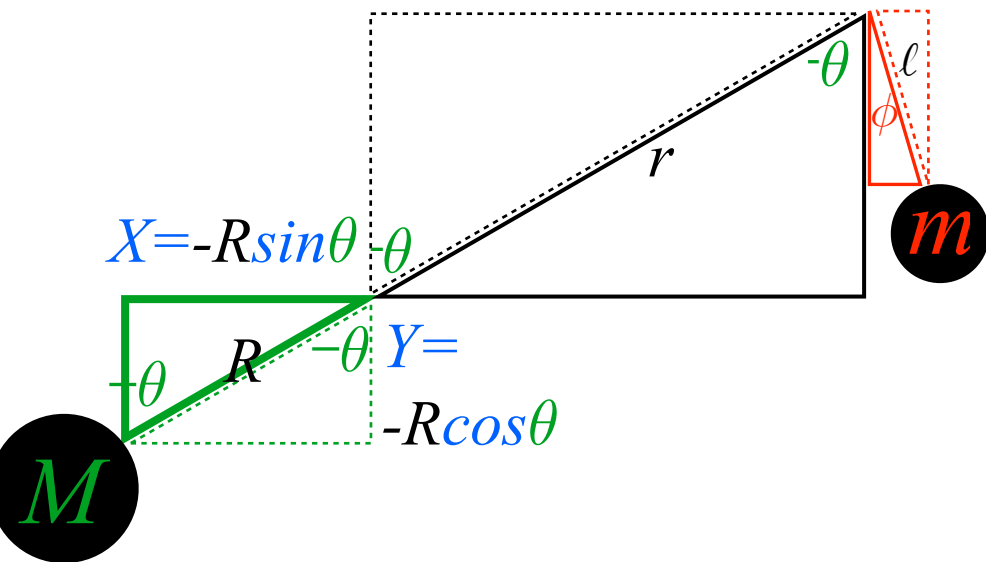

$$\begin{pmatrix} \dot{\theta} \\ \dot{\phi} \end{pmatrix} = \begin{pmatrix} \gamma^{\theta\theta} & \gamma^{\theta\phi} \\ \gamma^{\phi\theta} & \gamma^{\phi\phi} \end{pmatrix} \begin{pmatrix} p_\theta \\ p_\phi \end{pmatrix} \quad \text{Contravariant metric tensor } \gamma^{mn}$$

$$T = \frac{1}{2} \begin{pmatrix} p_\theta & p_\phi \end{pmatrix} \begin{pmatrix} ml^2 & mrl \cos(\theta - \phi) \\ mrl \cos(\theta - \phi) & MR^2 + mr^2 \end{pmatrix} \begin{pmatrix} p_\theta \\ p_\phi \end{pmatrix} = \frac{1}{2} \gamma^{mn} p_m p_n$$

$$ml^2 [MR^2 + mr^2 \sin^2(\theta - \phi)]$$

$$\begin{aligned} \dot{\theta} &= \gamma^{\theta\theta} p_\theta + \gamma^{\theta\phi} p_\phi \\ \dot{\phi} &= \gamma^{\phi\theta} p_\theta + \gamma^{\phi\phi} p_\phi \end{aligned}$$

$$\begin{aligned} p_\theta &= \gamma_{\theta\theta} \dot{\theta} + \gamma_{\theta\phi} \dot{\phi} \\ p_\phi &= \gamma_{\phi\theta} \dot{\theta} + \gamma_{\phi\phi} \dot{\phi} \end{aligned}$$

Coordinate equations

$$\frac{\partial H}{\partial p_\theta} = \dot{\theta} = \gamma^{\theta\theta} p_\theta + \gamma^{\theta\phi} p_\phi$$

$$\frac{\partial H}{\partial p_\phi} = \dot{\phi} = \gamma^{\phi\theta} p_\theta + \gamma^{\phi\phi} p_\phi$$

Momentum/force equations

$$\begin{aligned} \dot{p}_\theta &= -\frac{\partial H}{\partial \theta} = \frac{\partial L}{\partial \theta} = \frac{\partial T}{\partial \theta} - \frac{\partial V}{\partial \theta} \\ &= mrl \dot{\theta} \dot{\phi} \sin(\theta - \phi) + F_\theta \end{aligned}$$

$$\begin{aligned} \dot{p}_\phi &= -\frac{\partial H}{\partial \phi} = \frac{\partial L}{\partial \phi} = \frac{\partial T}{\partial \phi} - \frac{\partial V}{\partial \phi} \\ &= -mrl \dot{\theta} \dot{\phi} \sin(\theta - \phi) + F_\phi \end{aligned}$$

$$= mrl (\gamma^{\theta\theta} p_\theta + \gamma^{\theta\phi} p_\phi) (\gamma^{\phi\theta} p_\theta + \gamma^{\phi\phi} p_\phi) \sin(\theta - \phi) + F_\theta$$

$$= -mrl (\gamma^{\theta\theta} p_\theta + \gamma^{\theta\phi} p_\phi) (\gamma^{\phi\theta} p_\theta + \gamma^{\phi\phi} p_\phi) \sin(\theta - \phi) + F_\phi$$

$$= mrl (\gamma^{\theta\theta} \gamma^{\phi\theta} p_\theta^2 + [\gamma^{\theta\theta} \gamma^{\phi\phi} + (\gamma^{\theta\phi})^2] p_\phi p_\theta + \gamma^{\theta\phi} \gamma^{\phi\phi} p_\phi^2) \sin(\theta - \phi) + F_\theta$$

$$= -[\text{messy factor}] \sin(\theta - \phi) + F_\phi$$

A lesson on Hamiltonian “elegance” ...

...may be very elegant formally...but may not be so elegant algebraically!

Hamiltonian energy and momentum conservation and symmetry coordinates
→ *Coordinate transformation helps reduce symmetric Hamiltonian*
Free-space trebuchet kinematics by symmetry
Algebraic approach
Direct approach and Superball analogy
Trebuchet vs Flinger and sports kinematics
Many approaches to Mechanics

Coordinate transformation helps reduce symmetric Hamiltonian

Define beam-relative angle $\phi_B = \phi - \theta - \pi/2$ and $\theta_B = \theta + \pi/2$

Jacobian:

$$\begin{pmatrix} \dot{\theta}_B \\ \dot{\phi}_B \end{pmatrix} = \begin{pmatrix} \frac{\partial \theta_B}{\partial \theta} & \frac{\partial \theta_B}{\partial \phi} \\ \frac{\partial \phi_B}{\partial \theta} & \frac{\partial \phi_B}{\partial \phi} \end{pmatrix} \begin{pmatrix} \dot{\theta} \\ \dot{\phi} \end{pmatrix} = \begin{pmatrix} 1 & 0 \\ -1 & 1 \end{pmatrix} \begin{pmatrix} \dot{\theta} \\ \dot{\phi} \end{pmatrix}$$

Previous lab absolute trebuchet coordinate angles θ and ϕ

compared to

new angles θ_B and ϕ_B .

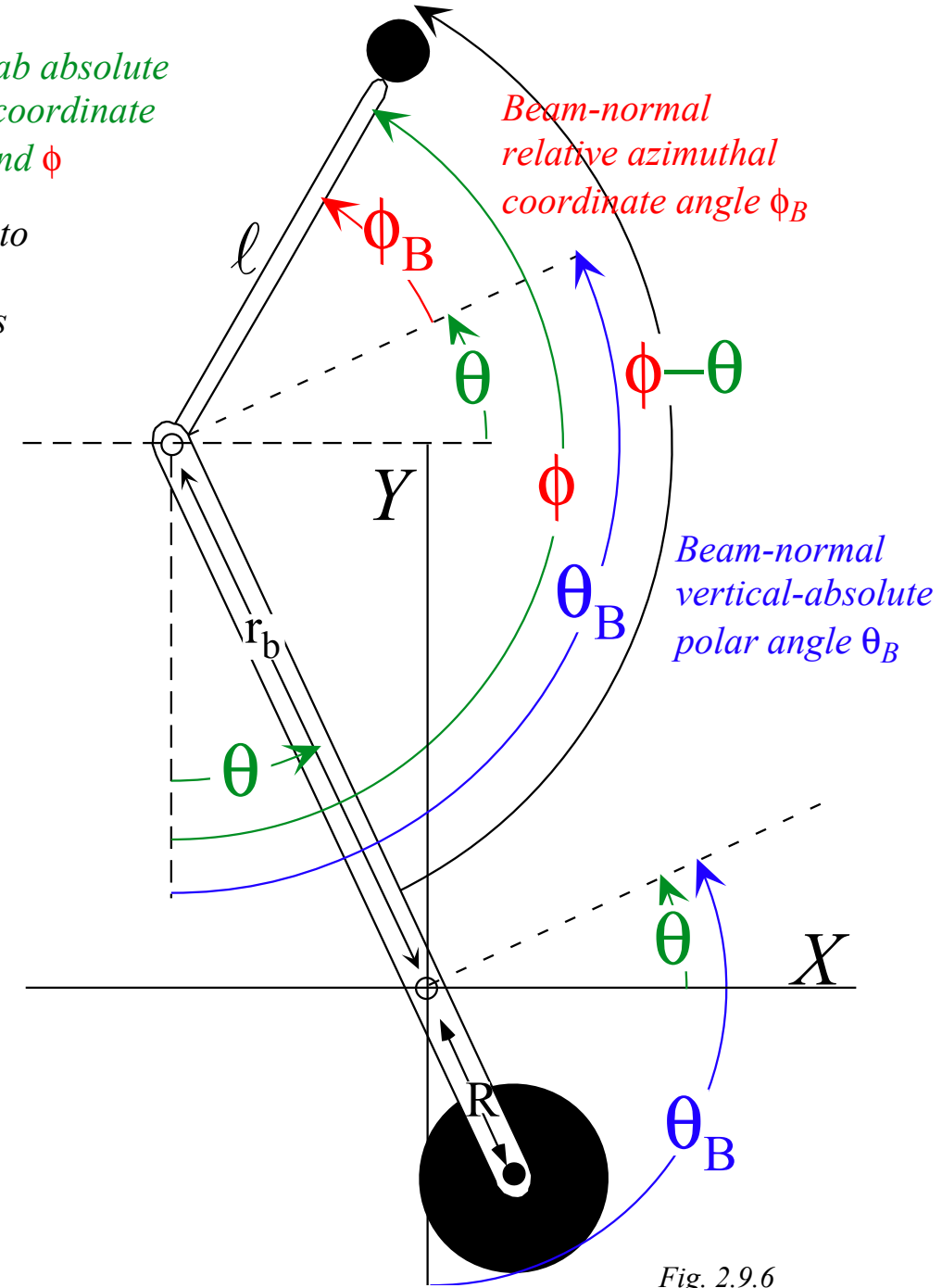

Fig. 2.9.6

Lab (θ, ϕ) and beam-normal (θ_B, ϕ_B) relative coordinates for trebuchet. (Each value is positive.)

Coordinate transformation helps reduce symmetric Hamiltonian

Define beam-relative angle $\phi_B = \phi - \theta - \pi/2$ and $\theta_B = \theta + \pi/2$

Jacobian:

$$\begin{pmatrix} \dot{\theta}_B \\ \dot{\phi}_B \end{pmatrix} = \begin{pmatrix} \frac{\partial \theta_B}{\partial \theta} & \frac{\partial \theta_B}{\partial \phi} \\ \frac{\partial \phi_B}{\partial \theta} & \frac{\partial \phi_B}{\partial \phi} \end{pmatrix} \begin{pmatrix} \dot{\theta} \\ \dot{\phi} \end{pmatrix} = \begin{pmatrix} 1 & 0 \\ -1 & 1 \end{pmatrix} \begin{pmatrix} \dot{\theta} \\ \dot{\phi} \end{pmatrix}$$

Kajobian of inverse transform $\phi_B = \phi - \theta - \pi/2$ and $\theta = \theta_B - \pi/2$

$$\begin{pmatrix} \dot{\theta} \\ \dot{\phi} \end{pmatrix} = \begin{pmatrix} \frac{\partial \theta}{\partial \theta_B} & \frac{\partial \theta}{\partial \phi_B} \\ \frac{\partial \phi}{\partial \theta_B} & \frac{\partial \phi}{\partial \phi_B} \end{pmatrix} \begin{pmatrix} \dot{\theta}_B \\ \dot{\phi}_B \end{pmatrix} = \begin{pmatrix} 1 & 0 \\ 1 & 1 \end{pmatrix} \begin{pmatrix} \dot{\theta}_B \\ \dot{\phi}_B \end{pmatrix} \quad \phi = \theta_B + \phi_B$$

Previous lab absolute trebuchet coordinate angles θ and ϕ

compared to

new angles θ_B and ϕ_B .

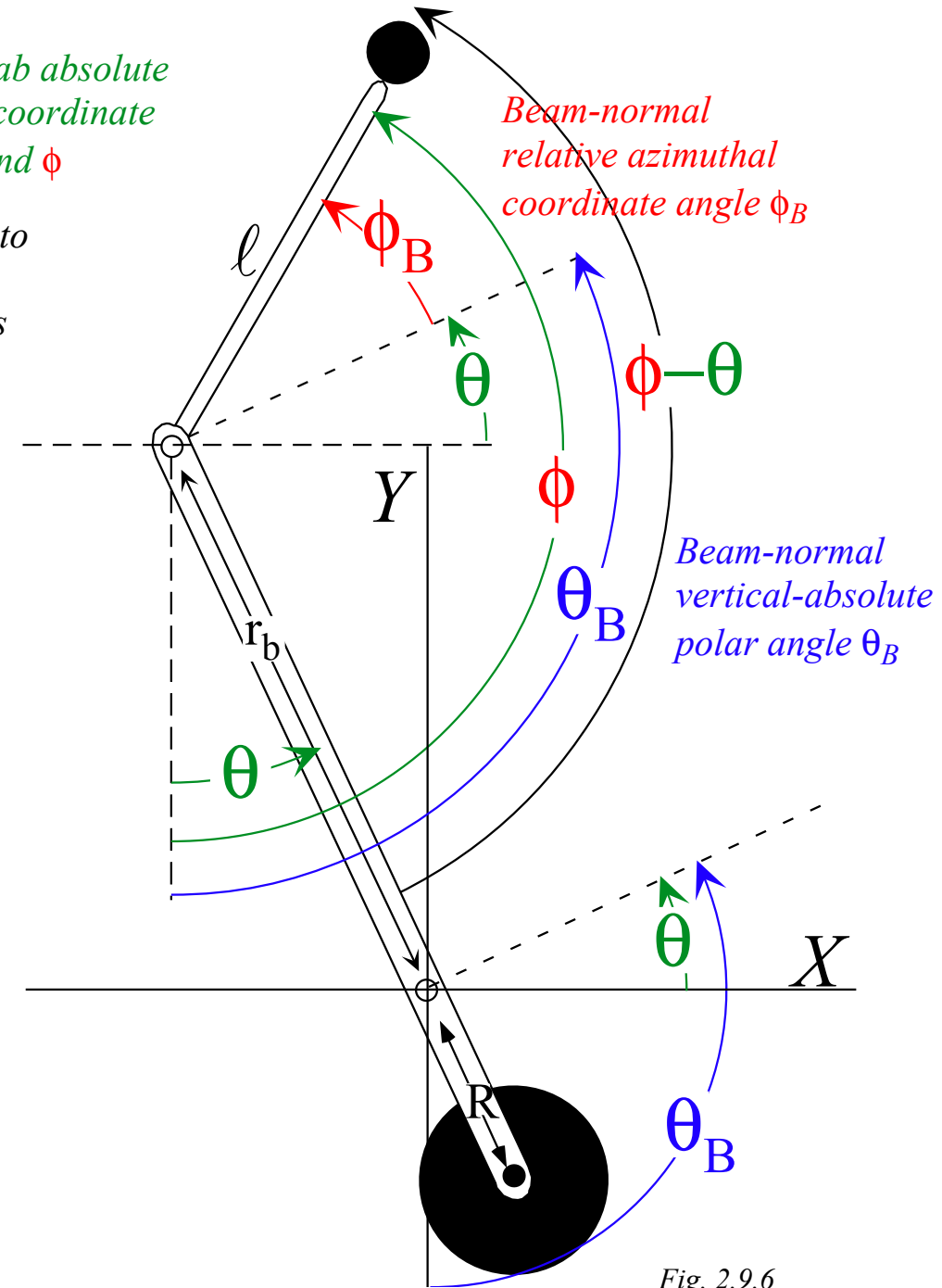

Fig. 2.9.6

Lab (θ, ϕ) and beam-normal (θ_B, ϕ_B) relative coordinates for trebuchet. (Each value is positive.)

Coordinate transformation helps reduce symmetric Hamiltonian

Define beam-relative angle $\phi_B = \phi - \theta - \pi/2$ and $\theta_B = \theta + \pi/2$

Jacobian:

$$\begin{pmatrix} \dot{\theta}_B \\ \dot{\phi}_B \end{pmatrix} = \begin{pmatrix} \frac{\partial \theta_B}{\partial \theta} & \frac{\partial \theta_B}{\partial \phi} \\ \frac{\partial \phi_B}{\partial \theta} & \frac{\partial \phi_B}{\partial \phi} \end{pmatrix} \begin{pmatrix} \dot{\theta} \\ \dot{\phi} \end{pmatrix} = \begin{pmatrix} 1 & 0 \\ -1 & 1 \end{pmatrix} \begin{pmatrix} \dot{\theta} \\ \dot{\phi} \end{pmatrix}$$

Kajobian of inverse transform $\phi_B = \phi - \theta - \pi/2$ and $\theta = \theta_B - \pi/2$

$$\begin{pmatrix} \dot{\theta} \\ \dot{\phi} \end{pmatrix} = \begin{pmatrix} \frac{\partial \theta}{\partial \theta_B} & \frac{\partial \theta}{\partial \phi_B} \\ \frac{\partial \phi}{\partial \theta_B} & \frac{\partial \phi}{\partial \phi_B} \end{pmatrix} \begin{pmatrix} \dot{\theta}_B \\ \dot{\phi}_B \end{pmatrix} = \begin{pmatrix} 1 & 0 \\ 1 & 1 \end{pmatrix} \begin{pmatrix} \dot{\theta}_B \\ \dot{\phi}_B \end{pmatrix}$$

$$\phi_B = -\theta + \phi - \pi/2$$

$$\phi = \theta_B + \phi_B$$

Be careful with momentum.
Poincare invariance is crucial!

Poincare invariant must remain invariant

$$p_\theta \dot{\theta} + p_\phi \dot{\phi} = \begin{pmatrix} \dot{\theta} & \dot{\phi} \end{pmatrix} \begin{pmatrix} p_\theta \\ p_\phi \end{pmatrix} = p_\theta^B \dot{\theta}_B + p_\phi^B \dot{\phi}_B$$

Previous lab absolute trebuchet coordinate angles θ and ϕ

compared to

new angles θ_B and ϕ_B .

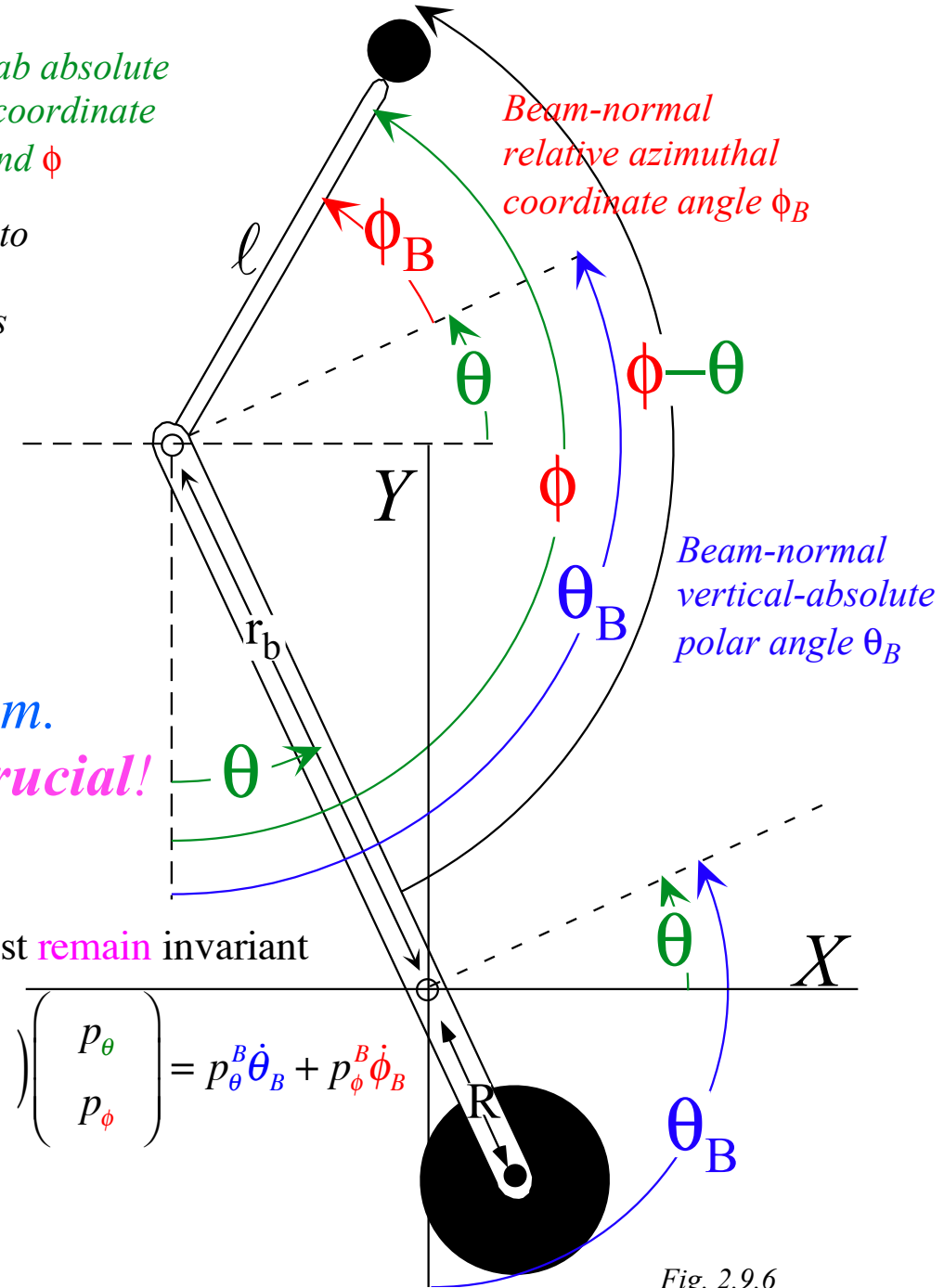

Fig. 2.9.6

Lab (θ, ϕ) and beam-normal (θ_B, ϕ_B) relative coordinates for trebuchet. (Each value is positive.)

Coordinate transformation helps reduce symmetric Hamiltonian

Define beam-relative angle $\phi_B = \phi - \theta - \pi/2$ and $\theta_B = \theta + \pi/2$

Jacobian:

$$\begin{pmatrix} \dot{\theta}_B \\ \dot{\phi}_B \end{pmatrix} = \begin{pmatrix} \frac{\partial \theta_B}{\partial \theta} & \frac{\partial \theta_B}{\partial \phi} \\ \frac{\partial \phi_B}{\partial \theta} & \frac{\partial \phi_B}{\partial \phi} \end{pmatrix} \begin{pmatrix} \dot{\theta} \\ \dot{\phi} \end{pmatrix} = \begin{pmatrix} 1 & 0 \\ -1 & 1 \end{pmatrix} \begin{pmatrix} \dot{\theta} \\ \dot{\phi} \end{pmatrix}$$

Kajobian of inverse transform $\phi_B = \phi - \theta - \pi/2$ and $\theta = \theta_B - \pi/2$

$$\begin{pmatrix} \dot{\theta} \\ \dot{\phi} \end{pmatrix} = \begin{pmatrix} \frac{\partial \theta}{\partial \theta_B} & \frac{\partial \theta}{\partial \phi_B} \\ \frac{\partial \phi}{\partial \theta_B} & \frac{\partial \phi}{\partial \phi_B} \end{pmatrix} \begin{pmatrix} \dot{\theta}_B \\ \dot{\phi}_B \end{pmatrix} = \begin{pmatrix} 1 & 0 \\ 1 & 1 \end{pmatrix} \begin{pmatrix} \dot{\theta}_B \\ \dot{\phi}_B \end{pmatrix}$$

$$\phi_B = -\theta + \phi - \pi/2$$

$$\phi = \theta_B + \phi_B$$

p_m transform is **TRANSPOSE INVERSE** to q^m

$$\begin{pmatrix} p_{\theta}^B \\ p_{\phi}^B \end{pmatrix} = \begin{pmatrix} \frac{\partial \theta}{\partial \theta_B} & \frac{\partial \phi}{\partial \theta_B} \\ \frac{\partial \theta}{\partial \phi_B} & \frac{\partial \phi}{\partial \phi_B} \end{pmatrix} \begin{pmatrix} p_{\theta} \\ p_{\phi} \end{pmatrix} = \begin{pmatrix} 1 & 1 \\ 0 & 1 \end{pmatrix} \begin{pmatrix} p_{\theta} \\ p_{\phi} \end{pmatrix}$$

$$\begin{pmatrix} p_{\theta} \\ p_{\phi} \end{pmatrix} = \begin{pmatrix} \frac{\partial \theta_B}{\partial \theta} & \frac{\partial \phi_B}{\partial \theta} \\ \frac{\partial \theta_B}{\partial \phi} & \frac{\partial \phi_B}{\partial \phi} \end{pmatrix} \begin{pmatrix} p_{\theta}^B \\ p_{\phi}^B \end{pmatrix} = \begin{pmatrix} 1 & -1 \\ 0 & 1 \end{pmatrix} \begin{pmatrix} p_{\theta}^B \\ p_{\phi}^B \end{pmatrix}$$

Be careful with momentum.
Poincare invariance is **crucial!**

Poincare invariant must **remain** invariant

$$p_{\theta} \dot{\theta} + p_{\phi} \dot{\phi} = \begin{pmatrix} \dot{\theta} & \dot{\phi} \end{pmatrix} \begin{pmatrix} p_{\theta} \\ p_{\phi} \end{pmatrix} = p_{\theta}^B \dot{\theta}_B + p_{\phi}^B \dot{\phi}_B$$

$$\begin{pmatrix} \dot{\theta}_B & \dot{\phi}_B \end{pmatrix} \begin{pmatrix} \frac{\partial \theta}{\partial \theta_B} & \frac{\partial \phi}{\partial \theta_B} \\ \frac{\partial \theta}{\partial \phi_B} & \frac{\partial \phi}{\partial \phi_B} \end{pmatrix} \begin{pmatrix} \frac{\partial \theta_B}{\partial \theta} & \frac{\partial \phi_B}{\partial \theta} \\ \frac{\partial \theta_B}{\partial \phi} & \frac{\partial \phi_B}{\partial \phi} \end{pmatrix} \begin{pmatrix} p_{\theta}^B \\ p_{\phi}^B \end{pmatrix}$$

Previous lab absolute trebuchet coordinate angles θ and ϕ

compared to

new angles θ_B and ϕ_B .

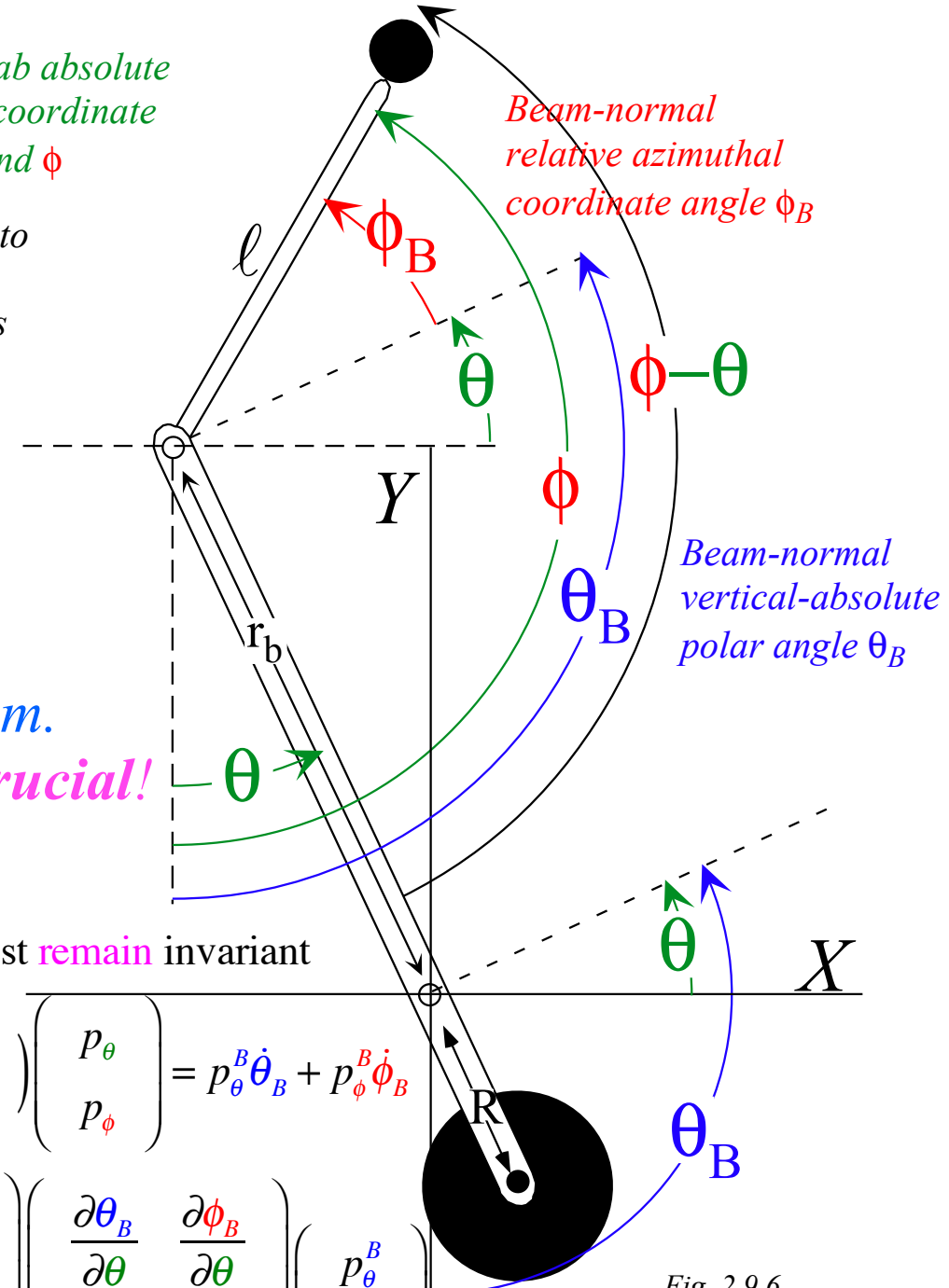

Fig. 2.9.6

Lab (θ, ϕ) and beam-normal (θ_B, ϕ_B) relative coordinates for trebuchet. (Each value is positive.)

Coordinate transformation helps reduce symmetric Hamiltonian

Define beam-relative angle $\phi_B = \phi - \theta - \pi/2$ and $\theta_B = \theta + \pi/2$

Jacobian:

$$\begin{pmatrix} \dot{\theta}_B \\ \dot{\phi}_B \end{pmatrix} = \begin{pmatrix} \frac{\partial \theta_B}{\partial \theta} & \frac{\partial \theta_B}{\partial \phi} \\ \frac{\partial \phi_B}{\partial \theta} & \frac{\partial \phi_B}{\partial \phi} \end{pmatrix} \begin{pmatrix} \dot{\theta} \\ \dot{\phi} \end{pmatrix} = \begin{pmatrix} 1 & 0 \\ -1 & 1 \end{pmatrix} \begin{pmatrix} \dot{\theta} \\ \dot{\phi} \end{pmatrix}$$

Kajobian of inverse transform $\phi_B = \phi - \theta - \pi/2$ and $\theta = \theta_B - \pi/2$

$$\begin{pmatrix} \dot{\theta} \\ \dot{\phi} \end{pmatrix} = \begin{pmatrix} \frac{\partial \theta}{\partial \theta_B} & \frac{\partial \theta}{\partial \phi_B} \\ \frac{\partial \phi}{\partial \theta_B} & \frac{\partial \phi}{\partial \phi_B} \end{pmatrix} \begin{pmatrix} \dot{\theta}_B \\ \dot{\phi}_B \end{pmatrix} = \begin{pmatrix} 1 & 0 \\ 1 & 1 \end{pmatrix} \begin{pmatrix} \dot{\theta}_B \\ \dot{\phi}_B \end{pmatrix}$$

$$\phi_B = -\theta + \phi - \pi/2$$

$$\phi = \theta_B + \phi_B$$

Be careful with momentum.

Poincare invariance is crucial!

p_m transform is TRANSPOSE INVERSE to q^m

$$\begin{pmatrix} p_{\theta}^B \\ p_{\phi}^B \end{pmatrix} = \begin{pmatrix} \frac{\partial \theta}{\partial \theta_B} & \frac{\partial \phi}{\partial \theta_B} \\ \frac{\partial \theta}{\partial \phi_B} & \frac{\partial \phi}{\partial \phi_B} \end{pmatrix} \begin{pmatrix} p_{\theta} \\ p_{\phi} \end{pmatrix} = \begin{pmatrix} 1 & 1 \\ 0 & 1 \end{pmatrix} \begin{pmatrix} p_{\theta} \\ p_{\phi} \end{pmatrix}$$

$$\begin{pmatrix} p_{\theta} \\ p_{\phi} \end{pmatrix} = \begin{pmatrix} \frac{\partial \theta_B}{\partial \theta} & \frac{\partial \phi_B}{\partial \theta} \\ \frac{\partial \theta_B}{\partial \phi} & \frac{\partial \phi_B}{\partial \phi} \end{pmatrix} \begin{pmatrix} p_{\theta}^B \\ p_{\phi}^B \end{pmatrix} = \begin{pmatrix} 1 & -1 \\ 0 & 1 \end{pmatrix} \begin{pmatrix} p_{\theta}^B \\ p_{\phi}^B \end{pmatrix}$$

Resulting momentum transform: $p_{\theta} = p_{\theta}^B - p_{\phi}^B$

$$p_{\phi} = p_{\phi}^B$$

Previous lab absolute trebuchet coordinate angles θ and ϕ

compared to

new angles θ_B and ϕ_B .

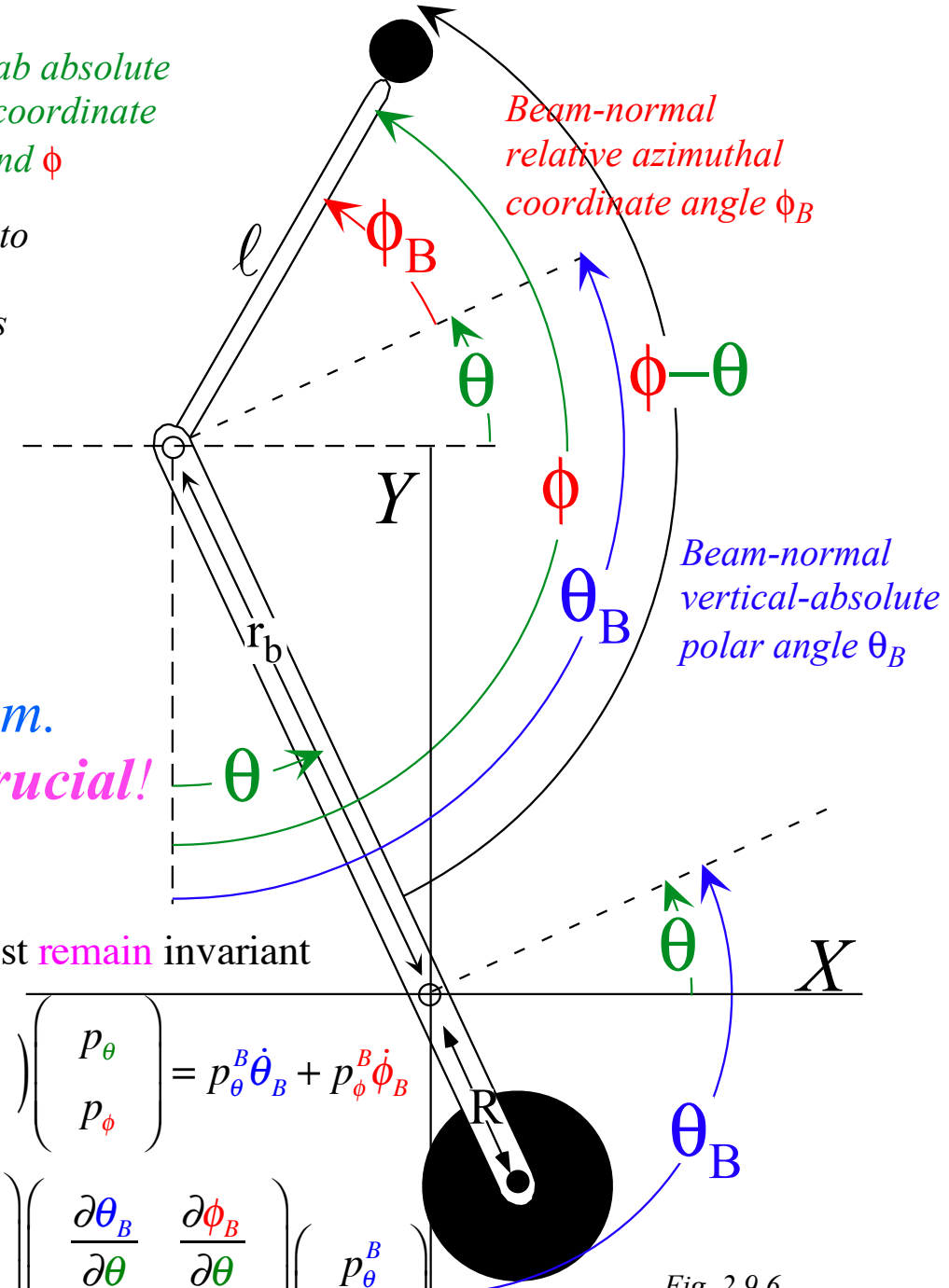

Poincare invariant must remain invariant

$$p_{\theta} \dot{\theta} + p_{\phi} \dot{\phi} = \begin{pmatrix} \dot{\theta} & \dot{\phi} \end{pmatrix} \begin{pmatrix} p_{\theta} \\ p_{\phi} \end{pmatrix} = p_{\theta}^B \dot{\theta}_B + p_{\phi}^B \dot{\phi}_B$$

$$\begin{pmatrix} \dot{\theta}_B & \dot{\phi}_B \end{pmatrix} \begin{pmatrix} \frac{\partial \theta}{\partial \theta_B} & \frac{\partial \phi}{\partial \theta_B} \\ \frac{\partial \theta}{\partial \phi_B} & \frac{\partial \phi}{\partial \phi_B} \end{pmatrix} \begin{pmatrix} \frac{\partial \theta_B}{\partial \theta} & \frac{\partial \phi_B}{\partial \theta} \\ \frac{\partial \theta_B}{\partial \phi} & \frac{\partial \phi_B}{\partial \phi} \end{pmatrix} \begin{pmatrix} p_{\theta}^B \\ p_{\phi}^B \end{pmatrix}$$

Fig. 2.9.6

Lab (θ, ϕ) and beam-normal (θ_B, ϕ_B) relative coordinates for trebuchet. (Each value is positive.)

Coordinate transformation helps reduce symmetric Hamiltonian

Define beam-relative angle $\phi_B = \phi - \theta - \pi/2$ and $\theta_B = \theta + \pi/2$

Jacobian: $\phi_B = -\theta + \phi - \pi/2$

$$\begin{pmatrix} \dot{\theta}_B \\ \dot{\phi}_B \end{pmatrix} = \begin{pmatrix} \frac{\partial \theta_B}{\partial \theta} & \frac{\partial \theta_B}{\partial \phi} \\ \frac{\partial \phi_B}{\partial \theta} & \frac{\partial \phi_B}{\partial \phi} \end{pmatrix} \begin{pmatrix} \dot{\theta} \\ \dot{\phi} \end{pmatrix} = \begin{pmatrix} 1 & 0 \\ -1 & 1 \end{pmatrix} \begin{pmatrix} \dot{\theta} \\ \dot{\phi} \end{pmatrix}$$

Kajobian of inverse transform $\phi_B = \phi - \theta - \pi/2$ and $\theta = \theta_B - \pi/2$

$$\begin{pmatrix} \dot{\theta} \\ \dot{\phi} \end{pmatrix} = \begin{pmatrix} \frac{\partial \theta}{\partial \theta_B} & \frac{\partial \theta}{\partial \phi_B} \\ \frac{\partial \phi}{\partial \theta_B} & \frac{\partial \phi}{\partial \phi_B} \end{pmatrix} \begin{pmatrix} \dot{\theta}_B \\ \dot{\phi}_B \end{pmatrix} = \begin{pmatrix} 1 & 0 \\ 1 & 1 \end{pmatrix} \begin{pmatrix} \dot{\theta}_B \\ \dot{\phi}_B \end{pmatrix} \quad \phi = \theta_B + \phi_B$$

p_m transform is **TRANPOSE INVERSE** to q^m

$$\begin{pmatrix} p_{\theta}^B \\ p_{\phi}^B \end{pmatrix} = \begin{pmatrix} \frac{\partial \theta}{\partial \theta_B} & \frac{\partial \phi}{\partial \theta_B} \\ \frac{\partial \theta}{\partial \phi_B} & \frac{\partial \phi}{\partial \phi_B} \end{pmatrix} \begin{pmatrix} p_{\theta} \\ p_{\phi} \end{pmatrix} = \begin{pmatrix} 1 & 1 \\ 0 & 1 \end{pmatrix} \begin{pmatrix} p_{\theta} \\ p_{\phi} \end{pmatrix}$$

$$\begin{pmatrix} p_{\theta} \\ p_{\phi} \end{pmatrix} = \begin{pmatrix} \frac{\partial \theta_B}{\partial \theta} & \frac{\partial \phi_B}{\partial \theta} \\ \frac{\partial \theta_B}{\partial \phi} & \frac{\partial \phi_B}{\partial \phi} \end{pmatrix} \begin{pmatrix} p_{\theta}^B \\ p_{\phi}^B \end{pmatrix} = \begin{pmatrix} 1 & -1 \\ 0 & 1 \end{pmatrix} \begin{pmatrix} p_{\theta}^B \\ p_{\phi}^B \end{pmatrix}$$

Resulting momentum transform: $p_{\theta} = p_{\theta}^B - p_{\phi}^B$

$$p_{\phi} = p_{\phi}^B$$

$$H = \frac{m\ell^2 p_{\theta} p_{\theta} + (MR^2 + mr^2) p_{\phi} p_{\phi} + 2mr\ell p_{\theta} p_{\phi} \cos(\theta - \phi)}{2m\ell^2 [MR^2 + mr^2 \sin^2(\theta - \phi)]} + V$$

Previous lab absolute trebuchet coordinate angles θ and ϕ

compared to

new angles θ_B and ϕ_B .

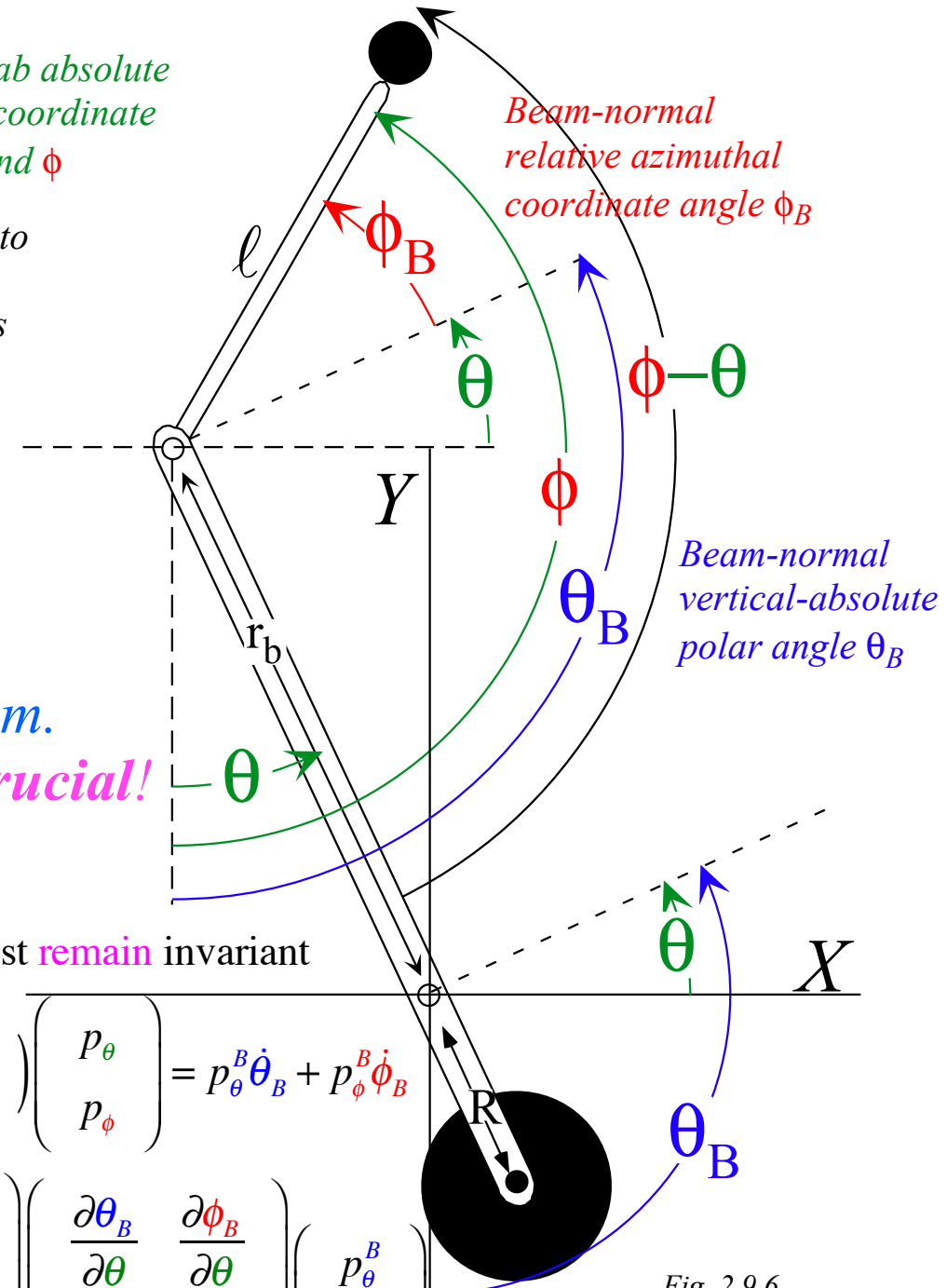

Be careful with momentum.
Poincare invariance is **crucial!**

Poincare invariant must **remain** invariant

$$p_{\theta} \dot{\theta} + p_{\phi} \dot{\phi} = \begin{pmatrix} \dot{\theta} & \dot{\phi} \end{pmatrix} \begin{pmatrix} p_{\theta} \\ p_{\phi} \end{pmatrix} = p_{\theta}^B \dot{\theta}_B + p_{\phi}^B \dot{\phi}_B$$

$$\begin{pmatrix} \dot{\theta}_B & \dot{\phi}_B \end{pmatrix} \begin{pmatrix} \frac{\partial \theta}{\partial \theta_B} & \frac{\partial \phi}{\partial \theta_B} \\ \frac{\partial \theta}{\partial \phi_B} & \frac{\partial \phi}{\partial \phi_B} \end{pmatrix} \begin{pmatrix} \frac{\partial \theta_B}{\partial \theta} & \frac{\partial \phi_B}{\partial \theta} \\ \frac{\partial \theta_B}{\partial \phi} & \frac{\partial \phi_B}{\partial \phi} \end{pmatrix} \begin{pmatrix} p_{\theta}^B \\ p_{\phi}^B \end{pmatrix}$$

Fig. 2.9.6

Lab (θ, ϕ) and beam-normal (θ_B, ϕ_B) relative coordinates for trebuchet. (Each value is positive.)

Original (ϕ, θ) Hamiltonian

Coordinate transformation helps reduce symmetric Hamiltonian

Define beam-relative angle $\phi_B = \phi - \theta - \pi/2$ and $\theta_B = \theta + \pi/2$

Jacobian: $\phi_B = -\theta + \phi - \pi/2$

$$\begin{pmatrix} \dot{\theta}_B \\ \dot{\phi}_B \end{pmatrix} = \begin{pmatrix} \frac{\partial \theta_B}{\partial \theta} & \frac{\partial \theta_B}{\partial \phi} \\ \frac{\partial \phi_B}{\partial \theta} & \frac{\partial \phi_B}{\partial \phi} \end{pmatrix} \begin{pmatrix} \dot{\theta} \\ \dot{\phi} \end{pmatrix} = \begin{pmatrix} 1 & 0 \\ -1 & 1 \end{pmatrix} \begin{pmatrix} \dot{\theta} \\ \dot{\phi} \end{pmatrix}$$

Kajobian of inverse transform $\phi_B = \phi - \theta - \pi/2$ and $\theta = \theta_B - \pi/2$

$$\begin{pmatrix} \dot{\theta} \\ \dot{\phi} \end{pmatrix} = \begin{pmatrix} \frac{\partial \theta}{\partial \theta_B} & \frac{\partial \theta}{\partial \phi_B} \\ \frac{\partial \phi}{\partial \theta_B} & \frac{\partial \phi}{\partial \phi_B} \end{pmatrix} \begin{pmatrix} \dot{\theta}_B \\ \dot{\phi}_B \end{pmatrix} = \begin{pmatrix} 1 & 0 \\ 1 & 1 \end{pmatrix} \begin{pmatrix} \dot{\theta}_B \\ \dot{\phi}_B \end{pmatrix} \quad \phi = \theta_B + \phi_B$$

p_m transform is **TRANSPOSE INVERSE** to q^m

$$\begin{pmatrix} p_{\theta}^B \\ p_{\phi}^B \end{pmatrix} = \begin{pmatrix} \frac{\partial \theta}{\partial \theta_B} & \frac{\partial \phi}{\partial \theta_B} \\ \frac{\partial \theta}{\partial \phi_B} & \frac{\partial \phi}{\partial \phi_B} \end{pmatrix} \begin{pmatrix} p_{\theta} \\ p_{\phi} \end{pmatrix} = \begin{pmatrix} 1 & 1 \\ 0 & 1 \end{pmatrix} \begin{pmatrix} p_{\theta} \\ p_{\phi} \end{pmatrix}$$

$$\begin{pmatrix} p_{\theta} \\ p_{\phi} \end{pmatrix} = \begin{pmatrix} \frac{\partial \theta_B}{\partial \theta} & \frac{\partial \phi_B}{\partial \theta} \\ \frac{\partial \theta_B}{\partial \phi} & \frac{\partial \phi_B}{\partial \phi} \end{pmatrix} \begin{pmatrix} p_{\theta}^B \\ p_{\phi}^B \end{pmatrix} = \begin{pmatrix} 1 & -1 \\ 0 & 1 \end{pmatrix} \begin{pmatrix} p_{\theta}^B \\ p_{\phi}^B \end{pmatrix}$$

Resulting momentum transform: $p_{\theta} = p_{\theta}^B - p_{\phi}^B$

$$p_{\phi} = p_{\phi}^B$$

$$\begin{pmatrix} \dot{\theta}_B & \dot{\phi}_B \end{pmatrix} \begin{pmatrix} \frac{\partial \theta}{\partial \theta_B} & \frac{\partial \phi}{\partial \theta_B} \\ \frac{\partial \theta}{\partial \phi_B} & \frac{\partial \phi}{\partial \phi_B} \end{pmatrix} \begin{pmatrix} \frac{\partial \theta_B}{\partial \theta} & \frac{\partial \phi_B}{\partial \theta} \\ \frac{\partial \theta_B}{\partial \phi} & \frac{\partial \phi_B}{\partial \phi} \end{pmatrix} \begin{pmatrix} p_{\theta}^B \\ p_{\phi}^B \end{pmatrix}$$

Poincare invariant must **remain** invariant

$$p_{\theta} \dot{\theta} + p_{\phi} \dot{\phi} = \begin{pmatrix} \dot{\theta} & \dot{\phi} \end{pmatrix} \begin{pmatrix} p_{\theta} \\ p_{\phi} \end{pmatrix} = p_{\theta}^B \dot{\theta}_B + p_{\phi}^B \dot{\phi}_B$$

$$H = \frac{m\ell^2 p_{\theta} p_{\theta} + (MR^2 + mr^2) p_{\phi} p_{\phi} + 2mr\ell p_{\theta} p_{\phi} \cos(\theta - \phi)}{2m\ell^2 [MR^2 + mr^2 \sin^2(\theta - \phi)]} + V$$

$$H = \frac{m\ell^2 (p_{\theta}^B - p_{\phi}^B)^2 + (MR^2 + mr^2) (p_{\phi}^B)^2 - 2mr\ell p_{\phi}^B (p_{\theta}^B - p_{\phi}^B) \sin \phi_B}{m\ell^2 [MR^2 + mr^2 \cos^2 \phi_B]} + V$$

Previous lab absolute trebuchet coordinate angles θ and ϕ

compared to new angles θ_B and ϕ_B .

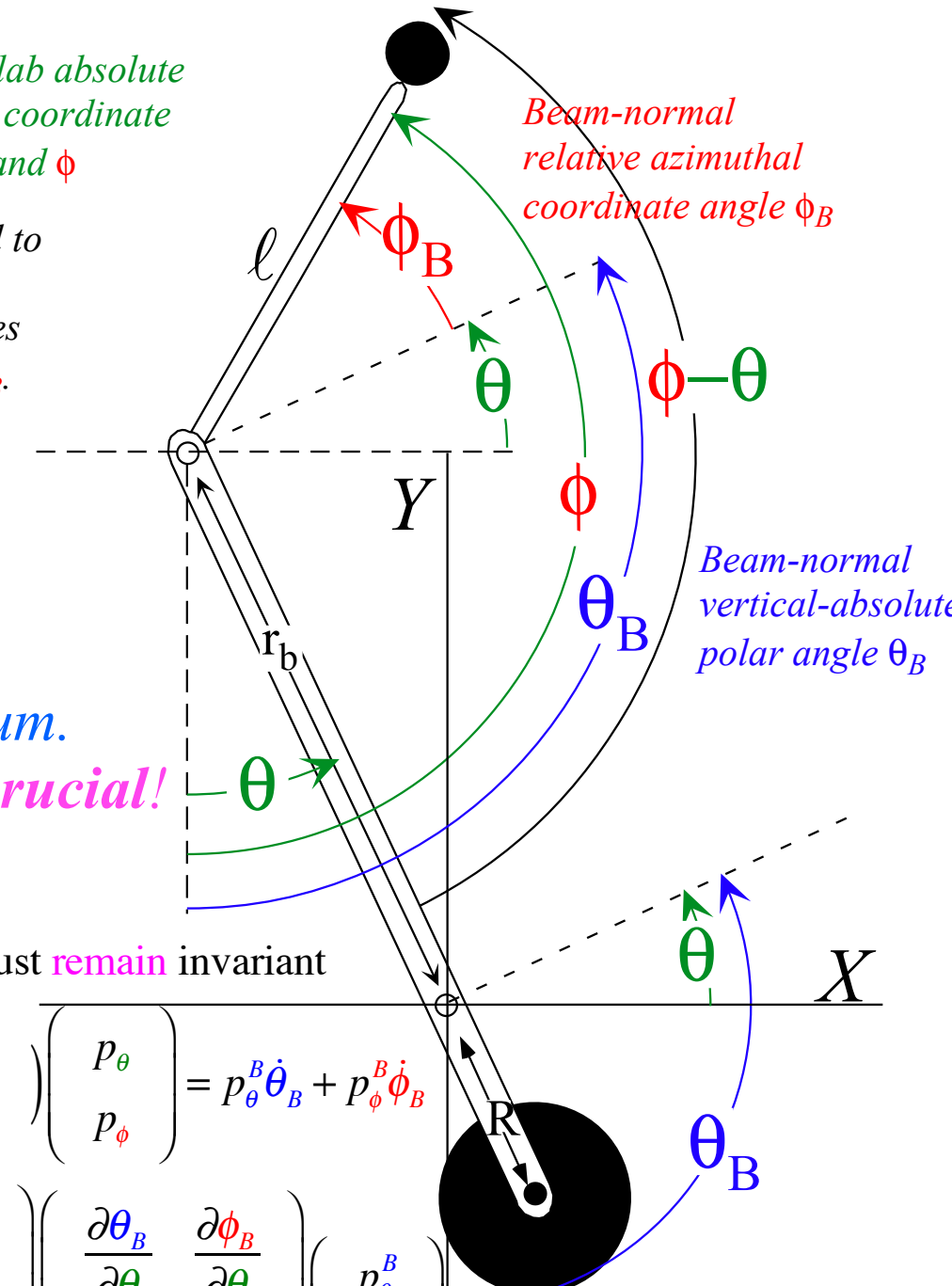

Fig. 2.9.6

Lab (θ, ϕ) and beam-normal (θ_B, ϕ_B) relative coordinates for trebuchet. (Each value is positive.)

Original (ϕ, θ) Hamiltonian

Transformed (ϕ_B, θ_B) Hamiltonian

Be careful with momentum. Poincare invariance is **crucial!**

Coordinate transformation helps reduce symmetric Hamiltonian

Define beam-relative angle $\phi_B = \phi - \theta - \pi/2$ and $\theta_B = \theta + \pi/2$

Jacobian: $\phi_B = -\theta + \phi - \pi/2$

$$\begin{pmatrix} \dot{\theta}_B \\ \dot{\phi}_B \end{pmatrix} = \begin{pmatrix} \frac{\partial \theta_B}{\partial \theta} & \frac{\partial \theta_B}{\partial \phi} \\ \frac{\partial \phi_B}{\partial \theta} & \frac{\partial \phi_B}{\partial \phi} \end{pmatrix} \begin{pmatrix} \dot{\theta} \\ \dot{\phi} \end{pmatrix} = \begin{pmatrix} 1 & 0 \\ -1 & 1 \end{pmatrix} \begin{pmatrix} \dot{\theta} \\ \dot{\phi} \end{pmatrix}$$

Kajobian of inverse transform $\phi_B = \phi - \theta - \pi/2$ and $\theta = \theta_B - \pi/2$

$$\begin{pmatrix} \dot{\theta} \\ \dot{\phi} \end{pmatrix} = \begin{pmatrix} \frac{\partial \theta}{\partial \theta_B} & \frac{\partial \theta}{\partial \phi_B} \\ \frac{\partial \phi}{\partial \theta_B} & \frac{\partial \phi}{\partial \phi_B} \end{pmatrix} \begin{pmatrix} \dot{\theta}_B \\ \dot{\phi}_B \end{pmatrix} = \begin{pmatrix} 1 & 0 \\ 1 & 1 \end{pmatrix} \begin{pmatrix} \dot{\theta}_B \\ \dot{\phi}_B \end{pmatrix} \quad \phi = \theta_B + \phi_B$$

p_m transform is **TRANSPOSE INVERSE** to q^m

$$\begin{pmatrix} p_{\theta}^B \\ p_{\phi}^B \end{pmatrix} = \begin{pmatrix} \frac{\partial \theta}{\partial \theta_B} & \frac{\partial \phi}{\partial \theta_B} \\ \frac{\partial \theta}{\partial \phi_B} & \frac{\partial \phi}{\partial \phi_B} \end{pmatrix} \begin{pmatrix} p_{\theta} \\ p_{\phi} \end{pmatrix} = \begin{pmatrix} 1 & 1 \\ 0 & 1 \end{pmatrix} \begin{pmatrix} p_{\theta} \\ p_{\phi} \end{pmatrix}$$

$$\begin{pmatrix} p_{\theta} \\ p_{\phi} \end{pmatrix} = \begin{pmatrix} \frac{\partial \theta_B}{\partial \theta} & \frac{\partial \phi_B}{\partial \theta} \\ \frac{\partial \theta_B}{\partial \phi} & \frac{\partial \phi_B}{\partial \phi} \end{pmatrix} \begin{pmatrix} p_{\theta}^B \\ p_{\phi}^B \end{pmatrix} = \begin{pmatrix} 1 & -1 \\ 0 & 1 \end{pmatrix} \begin{pmatrix} p_{\theta}^B \\ p_{\phi}^B \end{pmatrix}$$

Resulting momentum transform: $p_{\theta} = p_{\theta}^B - p_{\phi}^B$

$$p_{\phi} = p_{\phi}^B$$

$$\begin{pmatrix} \dot{\theta}_B & \dot{\phi}_B \end{pmatrix} \begin{pmatrix} \frac{\partial \theta}{\partial \theta_B} & \frac{\partial \phi}{\partial \theta_B} \\ \frac{\partial \theta}{\partial \phi_B} & \frac{\partial \phi}{\partial \phi_B} \end{pmatrix} \begin{pmatrix} \frac{\partial \theta_B}{\partial \theta} & \frac{\partial \phi_B}{\partial \theta} \\ \frac{\partial \theta_B}{\partial \phi} & \frac{\partial \phi_B}{\partial \phi} \end{pmatrix} \begin{pmatrix} p_{\theta}^B \\ p_{\phi}^B \end{pmatrix}$$

Poincare invariant must **remain** invariant

$$p_{\theta} \dot{\theta} + p_{\phi} \dot{\phi} = \begin{pmatrix} \dot{\theta} & \dot{\phi} \end{pmatrix} \begin{pmatrix} p_{\theta} \\ p_{\phi} \end{pmatrix} = p_{\theta}^B \dot{\theta}_B + p_{\phi}^B \dot{\phi}_B$$

Previous lab absolute trebuchet coordinate angles θ and ϕ

compared to

new angles

θ_B and ϕ_B .

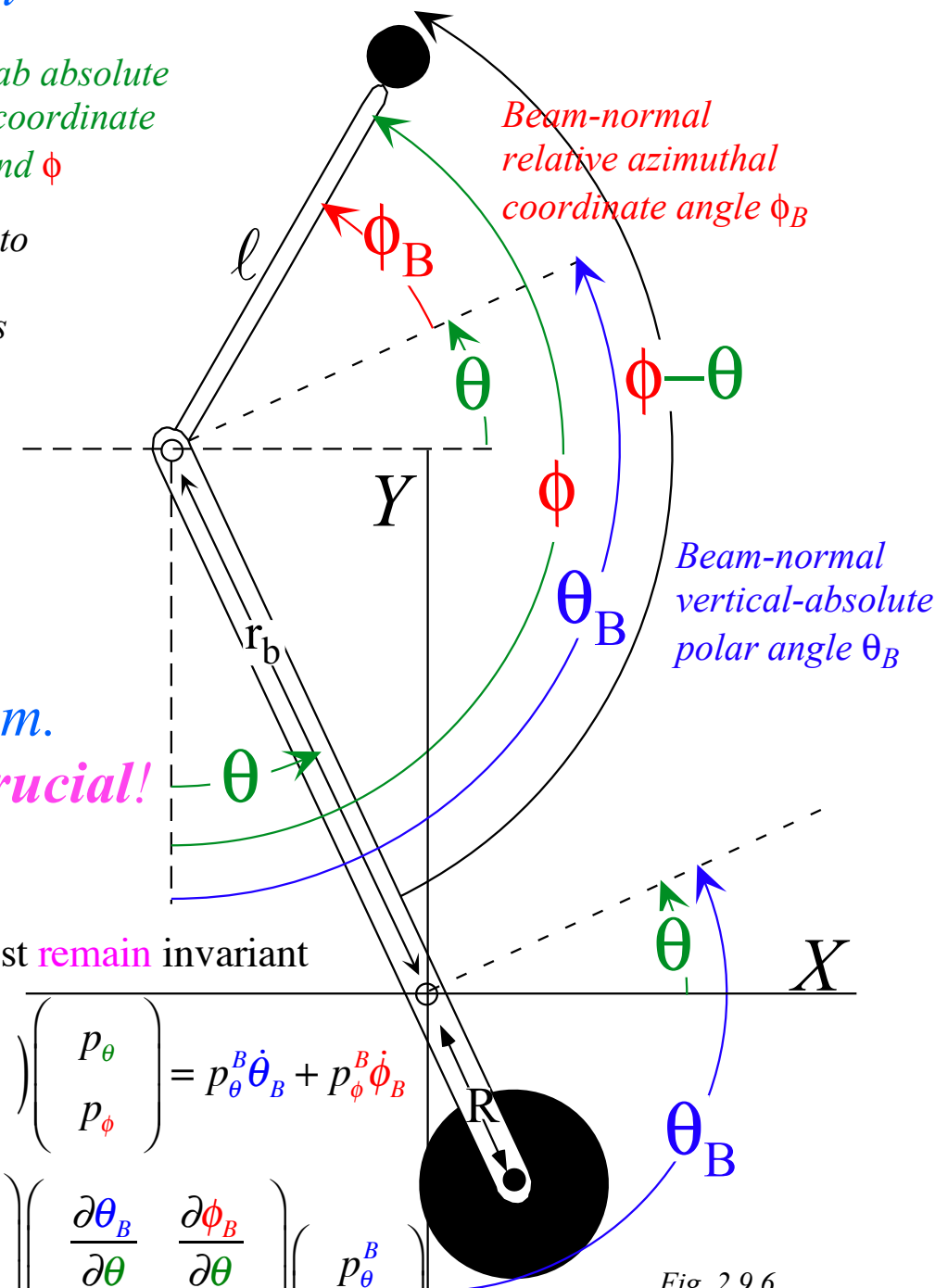

Fig. 2.9.6

Lab (θ, ϕ) and beam-normal (θ_B, ϕ_B) relative coordinates for trebuchet. (Each value is positive.)

$$F_{\theta} = -MgR \sin \theta + mgr \sin \theta$$

$$F_{\phi} = -mg \ell \sin \phi$$

$$H = \frac{m \ell^2 p_{\theta} p_{\theta} + (MR^2 + mr^2) p_{\phi} p_{\phi} + 2mr \ell p_{\theta} p_{\phi} \cos(\theta - \phi)}{2m \ell^2 [MR^2 + mr^2 \sin^2(\theta - \phi)]} + (MR - mr)g \cos \theta + mg \ell \cos \phi$$

$$\theta - \phi = -\pi/2 - \phi_B$$

$$H = \frac{m \ell^2 (p_{\theta}^B - p_{\phi}^B)^2 + (MR^2 + mr^2) (p_{\phi}^B)^2 - 2mr \ell p_{\phi}^B (p_{\theta}^B - p_{\phi}^B) \sin \phi_B}{m \ell^2 [MR^2 + mr^2 \cos^2 \phi_B]} - (MR - mr)g \sin \theta_B - mg \ell \cos(\phi_B + \theta_B)$$

Be careful with momentum.
Poincare invariance is **crucial!**

Hamiltonian energy and momentum conservation and symmetry coordinates

Coordinate transformation helps reduce symmetric Hamiltonian

Free-space trebuchet kinematics by symmetry

 *Algebraic approach*

Direct approach and Superball analogy

Trebuchet vs Flinger and sports kinematics

Many approaches to Mechanics

$$H = \frac{m\ell^2 \left(p_\theta^B - p_\phi^B \right)^2 + \left(MR^2 + mr^2 \right) \left(p_\phi^B \right)^2 - 2mr\ell p_\phi^B \left(p_\theta^B - p_\phi^B \right) \sin \phi_B}{m\ell^2 \left[MR^2 + mr^2 \cos^2 \phi_B \right]} - \left(MR - mr \right) g \sin \theta_B - mgl \cos \left(\phi_B + \theta_B \right)$$

(Assume zero-gravity)

For zero-gravity H is not a function of θ_B

so : $\dot{p}_\theta^B = \frac{\partial H}{\partial \theta_B} = 0$ and : $p_\theta^B = \Lambda = \text{const.}$

H is not an explicit function of t so : $H = \text{const.} = E$

Previous lab absolute trebuchet coordinate angles θ and ϕ

compared to

new angles θ_B and ϕ_B .

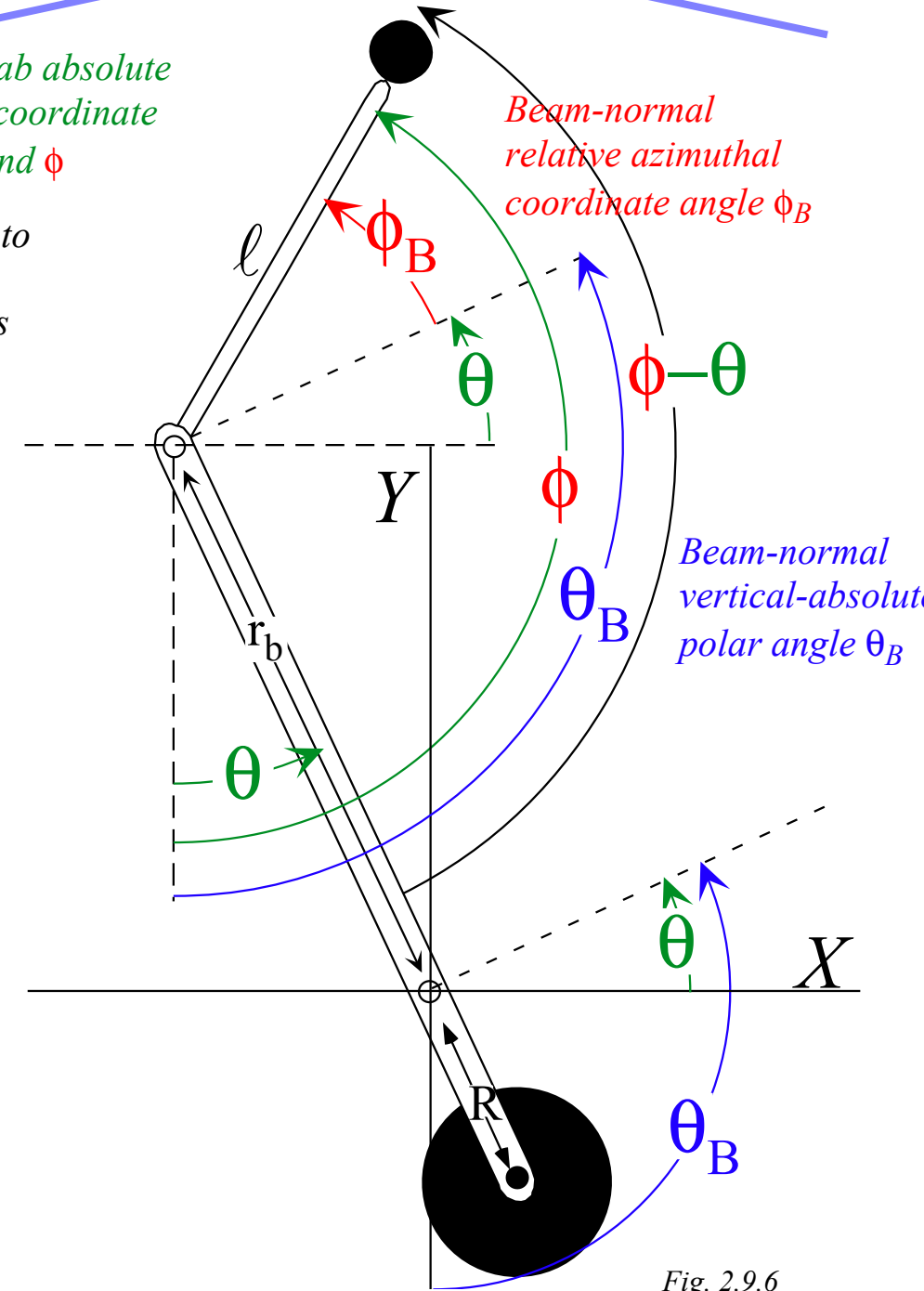

Fig. 2.9.6

Lab (θ, ϕ) and beam-normal (θ_B, ϕ_B) relative coordinates for trebuchet. (Each value is positive.)

$$H = \frac{m\ell^2 \left(p_\theta^B - p_\phi^B \right)^2 + \left(MR^2 + mr^2 \right) \left(p_\phi^B \right)^2 - 2mr\ell p_\phi^B \left(p_\theta^B - p_\phi^B \right) \sin \phi_B}{m\ell^2 \left[MR^2 + mr^2 \cos^2 \phi_B \right]} - \left(MR - mr \right) g \sin \theta_B - mgl \cos \left(\phi_B + \theta_B \right)$$

(Assume zero-gravity)

For zero-gravity H is not a function of θ_B

so : $\dot{p}_\theta^B = \frac{\partial H}{\partial \theta_B} = 0$ and : $p_\theta^B = \Lambda = \text{const.}$

H is not an explicit function of t so : $H = \text{const.} = E$

$$H = \frac{m\ell^2 \left(\Lambda - p_\phi^B \right)^2 + \left(MR^2 + mr^2 \right) \left(p_\phi^B \right)^2 - 2mr\ell p_\phi^B \left(\Lambda - p_\phi^B \right) \sin \phi_B}{m\ell^2 \left[MR^2 + mr^2 \cos^2 \phi_B \right]} = \text{const.} = E$$

Previous lab absolute trebuchet coordinate angles θ and ϕ

compared to

new angles θ_B and ϕ_B .

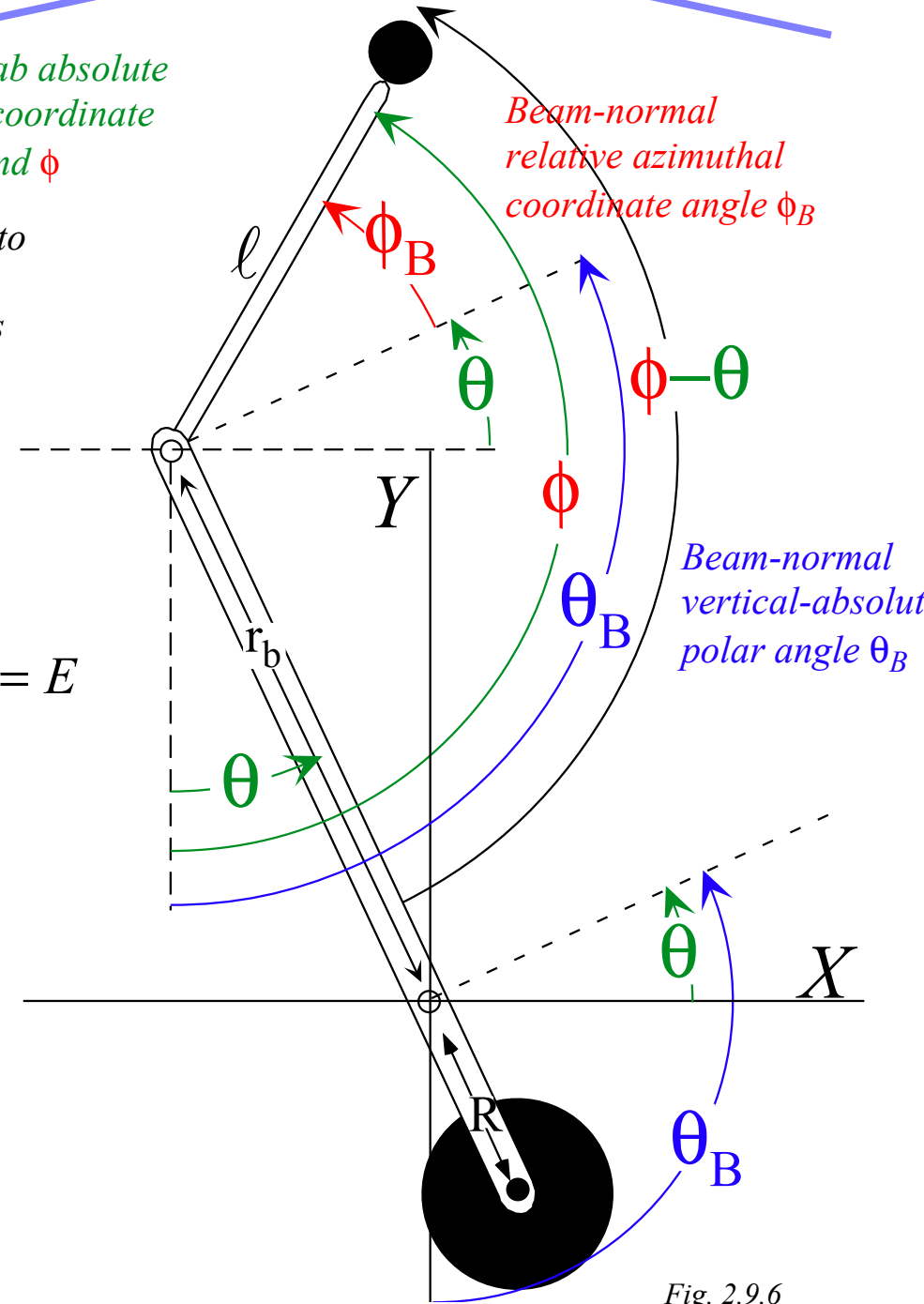

Fig. 2.9.6

Lab (θ, ϕ) and beam-normal (θ_B, ϕ_B) relative coordinates for trebuchet.

(Each value is positive.)

$$H = \frac{m\ell^2 \left(p_\theta^B - p_\phi^B \right)^2 + \left(MR^2 + mr^2 \right) \left(p_\phi^B \right)^2 - 2mr\ell p_\phi^B \left(p_\theta^B - p_\phi^B \right) \sin \phi_B}{m\ell^2 \left[MR^2 + mr^2 \cos^2 \phi_B \right]} - \left(MR - mr \right) g \sin \theta_B - mgl \cos \left(\phi_B + \theta_B \right)$$

(Assume zero-gravity)

For zero-gravity H is not a function of θ_B

so : $\dot{p}_\theta^B = \frac{\partial H}{\partial \theta_B} = 0$ and : $p_\theta^B = \Lambda = \text{const.}$

H is not an explicit function of t so : $H = \text{const.} = E$

$$H = \frac{m\ell^2 \left(\Lambda - p_\phi^B \right)^2 + \left(MR^2 + mr^2 \right) \left(p_\phi^B \right)^2 - 2mr\ell p_\phi^B \left(\Lambda - p_\phi^B \right) \sin \phi_B}{m\ell^2 \left[MR^2 + mr^2 \cos^2 \phi_B \right]} = \text{const.} = E$$

Rewrite $H=E$ as a quadratic equation in p_ϕ :

$$m\ell^2 \left(\Lambda^2 - 2\Lambda(p_\phi^B) + (p_\phi^B)^2 \right) + \left(MR^2 + mr^2 \right) (p_\phi^B)^2 - 2mr\ell(p_\phi^B) \left(\Lambda - p_\phi^B \right) \sin \phi_B = Em\ell^2 \left[MR^2 + mr^2 \cos^2 \phi_B \right]$$

Previous lab absolute trebuchet coordinate angles θ and ϕ

compared to

new angles θ_B and ϕ_B .

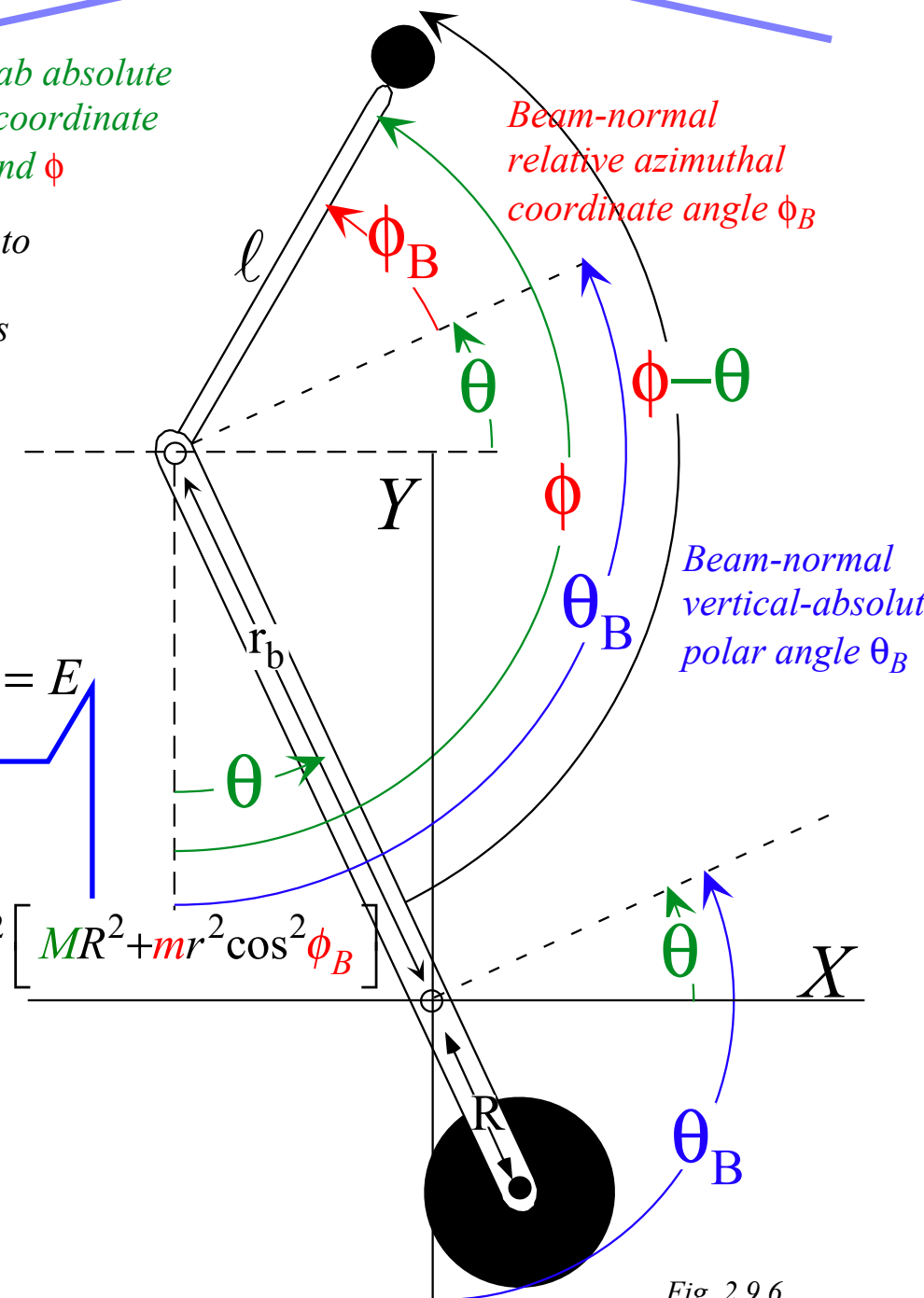

Fig. 2.9.6

Lab (θ, ϕ) and beam-normal (θ_B, ϕ_B) relative coordinates for trebuchet. (Each value is positive.)

Throwing-momentum p_ϕ^B is a function of beam-relative angle ϕ_B , total E , and $\Lambda = p_\theta^B$.

$$H = \frac{m\ell^2 (p_\theta^B - p_\phi^B)^2 + (MR^2 + mr^2)(p_\phi^B)^2 - 2mr\ell p_\phi^B (p_\theta^B - p_\phi^B) \sin \phi_B}{m\ell^2 [MR^2 + mr^2 \cos^2 \phi_B]} - (MR - mr)g \sin \theta_B - mg\ell \cos(\phi_B + \theta_B)$$

(Assume zero-gravity)

For zero-gravity H is not a function of θ_B

so : $\dot{p}_\theta^B = \frac{\partial H}{\partial \theta_B} = 0$ and : $p_\theta^B = \Lambda = \text{const.}$

H is not an explicit function of t so : $H = \text{const.} = E$

$$H = \frac{m\ell^2 (\Lambda - p_\phi^B)^2 + (MR^2 + mr^2)(p_\phi^B)^2 - 2mr\ell p_\phi^B (\Lambda - p_\phi^B) \sin \phi_B}{m\ell^2 [MR^2 + mr^2 \cos^2 \phi_B]} = \text{const.} = E$$

Rewrite $H=E$ as a quadratic equation in p_ϕ :

$$m\ell^2 (\Lambda^2 - 2\Lambda(p_\phi^B) + (p_\phi^B)^2) + (MR^2 + mr^2)(p_\phi^B)^2 - 2mr\ell(p_\phi^B)(\Lambda - p_\phi^B) \sin \phi_B = Em\ell^2 [MR^2 + mr^2 \cos^2 \phi_B]$$

$$m\ell^2 \Lambda^2 - 2m\ell^2 \Lambda(p_\phi^B) + (m\ell^2 + 2mr\ell \sin \phi_B + MR^2 + mr^2)(p_\phi^B)^2 - 2mr\ell \Lambda \sin \phi_B (p_\phi^B) = Em\ell^2 [MR^2 + mr^2 \cos^2 \phi_B]$$

Previous lab absolute trebuchet coordinate angles θ and ϕ
 compared to new angles θ_B and ϕ_B .

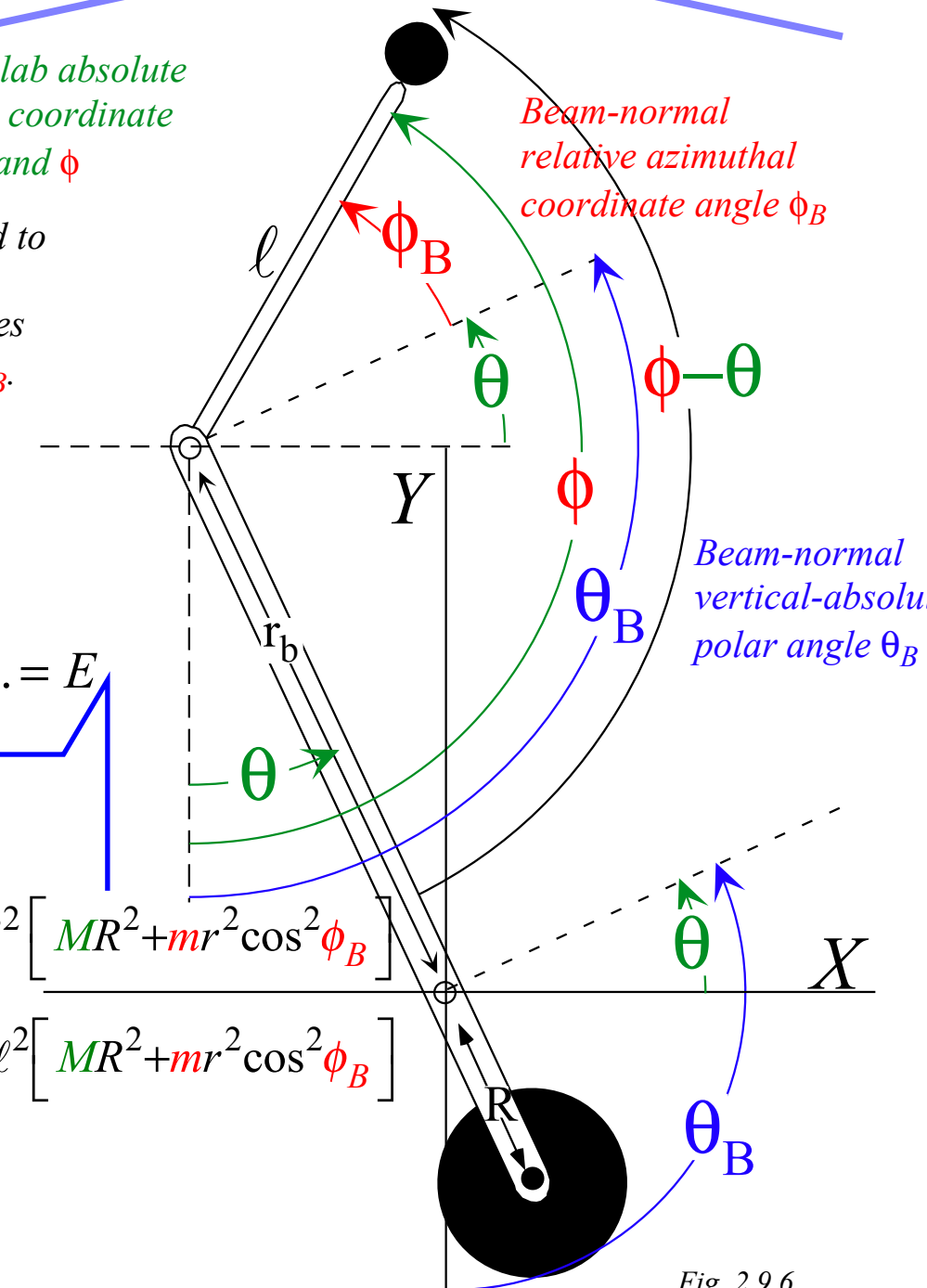

Fig. 2.9.6

Lab (θ, ϕ) and beam-normal (θ_B, ϕ_B) relative coordinates for trebuchet. (Each value is positive.)

Throwing-momentum p_ϕ^B is a function of beam-relative angle ϕ_B , total E , and $\Lambda = p_\theta^B$.

$$H = \frac{m\ell^2 \left(p_\theta^B - p_\phi^B \right)^2 + \left(MR^2 + mr^2 \right) \left(p_\phi^B \right)^2 - 2mr\ell p_\phi^B \left(p_\theta^B - p_\phi^B \right) \sin \phi_B}{m\ell^2 \left[MR^2 + mr^2 \cos^2 \phi_B \right]} - \left(MR - mr \right) g \sin \theta_B - mgl \cos \left(\phi_B + \theta_B \right)$$

(Assume zero-gravity)

For zero-gravity H is not a function of θ_B

so : $\dot{p}_\theta^B = \frac{\partial H}{\partial \theta_B} = 0$ and : $p_\theta^B = \Lambda = \text{const.}$

H is not an explicit function of t so : $H = \text{const.} = E$

$$H = \frac{m\ell^2 \left(\Lambda - p_\phi^B \right)^2 + \left(MR^2 + mr^2 \right) \left(p_\phi^B \right)^2 - 2mr\ell p_\phi^B \left(\Lambda - p_\phi^B \right) \sin \phi_B}{m\ell^2 \left[MR^2 + mr^2 \cos^2 \phi_B \right]} = \text{const.} = E$$

Rewrite $H=E$ as a quadratic equation in p_ϕ :

$$m\ell^2 \left(\Lambda^2 - 2\Lambda(p_\phi^B) + (p_\phi^B)^2 \right) + \left(MR^2 + mr^2 \right) \left(p_\phi^B \right)^2 - 2mr\ell(p_\phi^B) \left(\Lambda - p_\phi^B \right) \sin \phi_B = Em\ell^2 \left[MR^2 + mr^2 \cos^2 \phi_B \right]$$

$$m\ell^2 \Lambda^2 - 2m\ell^2 \Lambda(p_\phi^B) + \left(m\ell^2 + 2mr\ell \sin \phi_B + MR^2 + mr^2 \right) \left(p_\phi^B \right)^2 - 2mr\ell \Lambda \sin \phi_B (p_\phi^B) = Em\ell^2 \left[MR^2 + mr^2 \cos^2 \phi_B \right]$$

$$\left(m\ell^2 + 2mr\ell \sin \phi_B + MR^2 + mr^2 \right) \left(p_\phi^B \right)^2 - 2\Lambda \left(mr\ell \sin \phi_B + m\ell^2 \right) \left(p_\phi^B \right) + m\ell^2 \Lambda^2 - Em\ell^2 \left[MR^2 + mr^2 - mr^2 \sin^2 \phi_B \right] = 0$$

Previous lab absolute trebuchet coordinate angles θ and ϕ

compared to

new angles θ_B and ϕ_B .

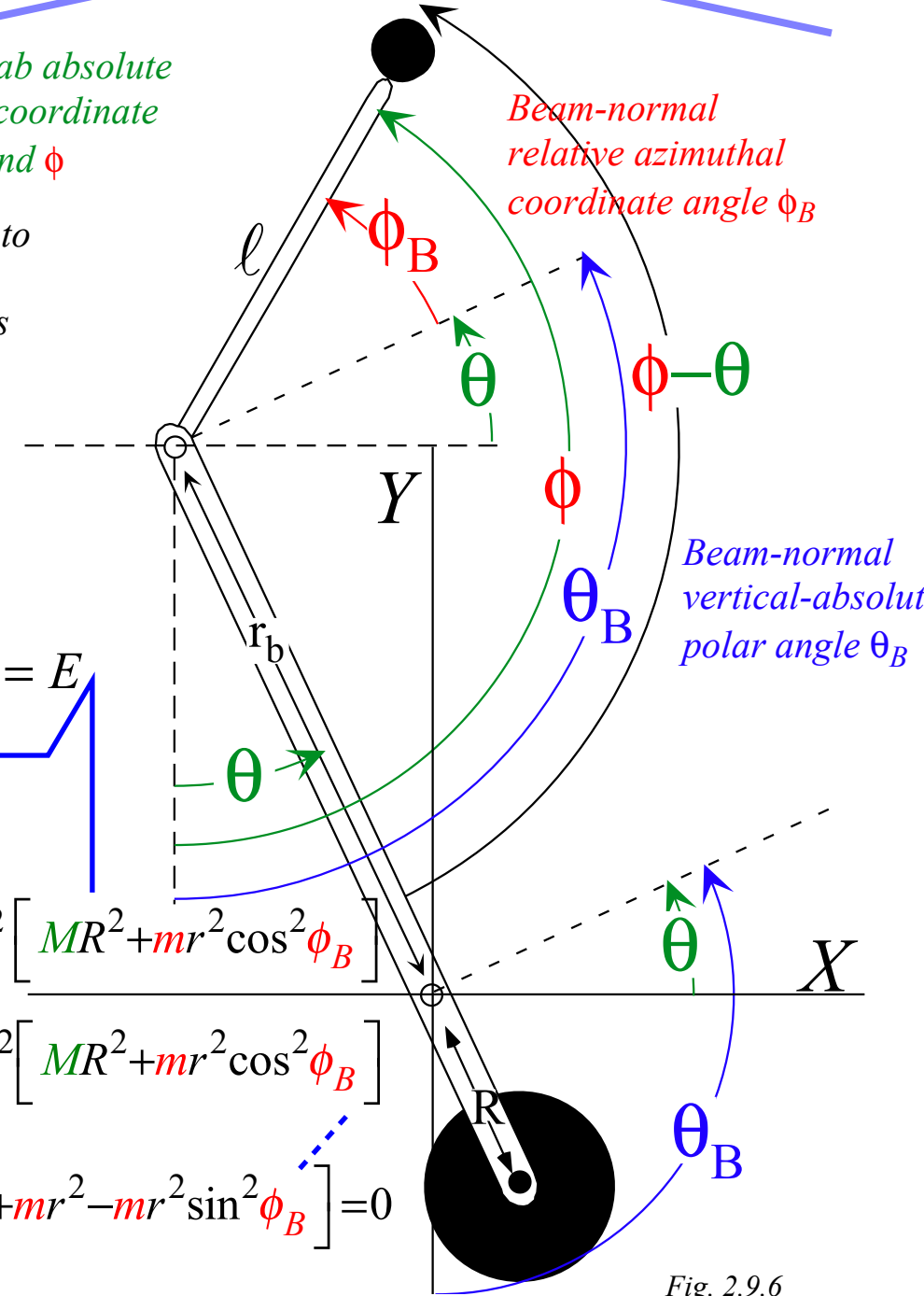

Fig. 2.9.6

Lab (θ, ϕ) and beam-normal (θ_B, ϕ_B) relative coordinates for trebuchet. (Each value is positive.)

Throwing-momentum p_ϕ^B is a function of beam-relative angle ϕ_B , total E , and $\Lambda = p_\theta^B$.

$$H = \frac{m\ell^2 \left(p_\theta^B - p_\phi^B \right)^2 + \left(MR^2 + mr^2 \right) \left(p_\phi^B \right)^2 - 2mr\ell p_\phi^B \left(p_\theta^B - p_\phi^B \right) \sin \phi_B}{m\ell^2 \left[MR^2 + mr^2 \cos^2 \phi_B \right]} - \left(MR - mr \right) g \sin \theta_B - mgl \cos \left(\phi_B + \theta_B \right)$$

(Assume zero-gravity)

For zero-gravity H is not a function of θ_B

so : $\dot{p}_\theta^B = \frac{\partial H}{\partial \theta_B} = 0$ and : $p_\theta^B = \Lambda = \text{const.}$

H is not an explicit function of t so : $H = \text{const.} = E$

$$H = \frac{m\ell^2 \left(\Lambda - p_\phi^B \right)^2 + \left(MR^2 + mr^2 \right) \left(p_\phi^B \right)^2 - 2mr\ell p_\phi^B \left(\Lambda - p_\phi^B \right) \sin \phi_B}{m\ell^2 \left[MR^2 + mr^2 \cos^2 \phi_B \right]} = \text{const.} = E$$

Rewrite $H=E$ as a quadratic equation in p_ϕ :

$$m\ell^2 \left(\Lambda^2 - 2\Lambda(p_\phi^B) + (p_\phi^B)^2 \right) + \left(MR^2 + mr^2 \right) \left(p_\phi^B \right)^2 - 2mr\ell(p_\phi^B) \left(\Lambda - p_\phi^B \right) \sin \phi_B = Em\ell^2 \left[MR^2 + mr^2 \cos^2 \phi_B \right]$$

$$m\ell^2 \Lambda^2 - 2m\ell^2 \Lambda(p_\phi^B) + \left(m\ell^2 + 2mr\ell \sin \phi_B + MR^2 + mr^2 \right) \left(p_\phi^B \right)^2 - 2mr\ell \Lambda \sin \phi_B (p_\phi^B) = Em\ell^2 \left[MR^2 + mr^2 \cos^2 \phi_B \right]$$

$$\left(m\ell^2 + 2mr\ell \sin \phi_B + MR^2 + mr^2 \right) \left(p_\phi^B \right)^2 - 2\Lambda \left(mr\ell \sin \phi_B + m\ell^2 \right) \left(p_\phi^B \right) + m\ell^2 \Lambda^2 - Em\ell^2 \left[MR^2 + mr^2 - mr^2 \sin^2 \phi_B \right] = 0$$

$$\left(1 + 2(r/\ell) \sin \phi_B + J \right) \left(p_\phi^B \right)^2 - 2\Lambda \left((r/\ell) \sin \phi_B + 1 \right) \left(p_\phi^B \right) + \Lambda^2 - E \left[I - mr^2 \sin^2 \phi_B \right] = 0$$

Throwing-momentum p_ϕ^B is a function of beam-relative angle ϕ_B , total E , and $\Lambda = p_\theta^B$.

with: $J = \frac{MR^2 + mr^2}{m\ell^2}$, $I = MR^2 + mr^2$

Previous lab absolute trebuchet coordinate angles θ and ϕ

compared to

new angles θ_B and ϕ_B .

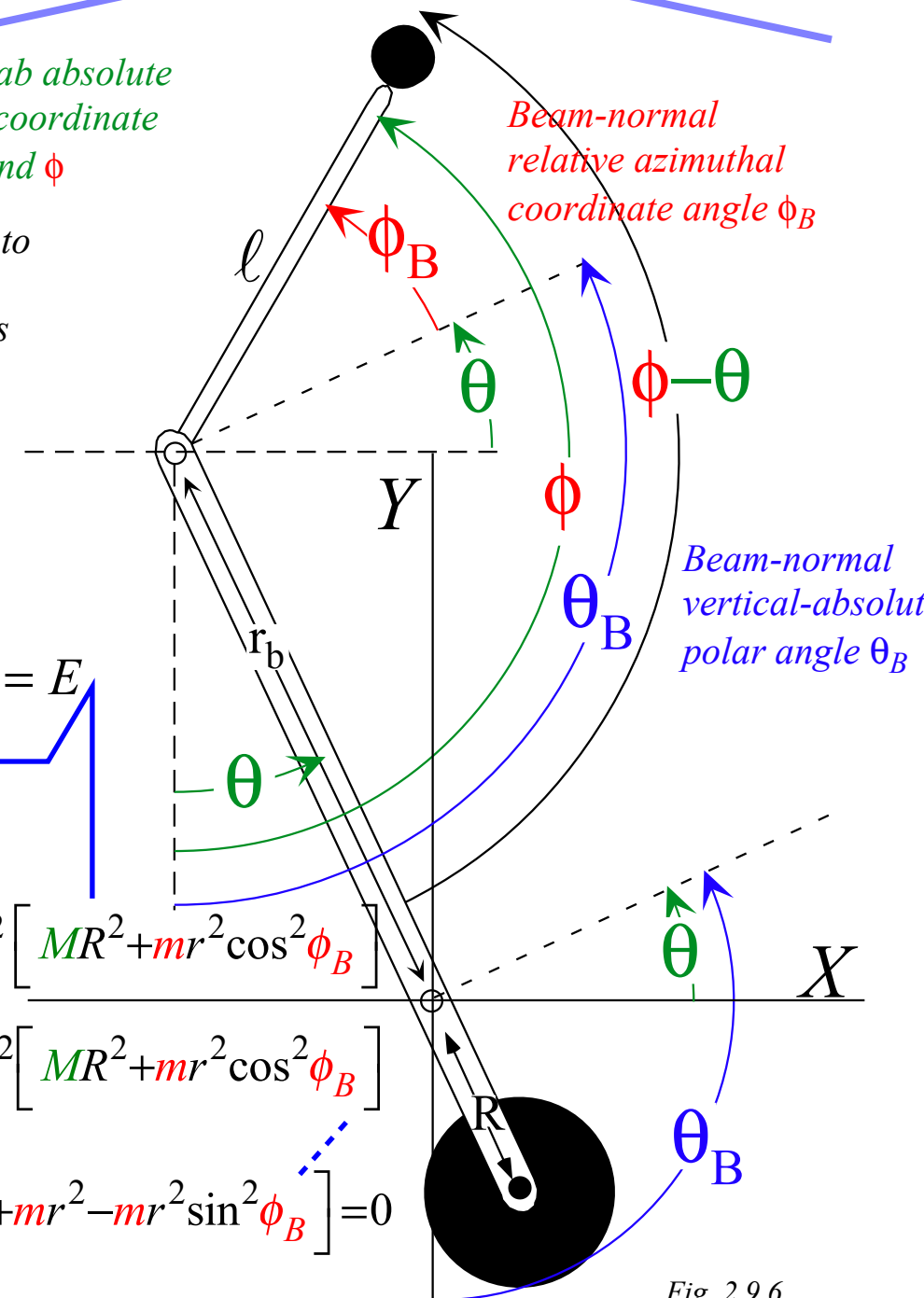

Fig. 2.9.6

Lab (θ, ϕ) and beam-normal (θ_B, ϕ_B) relative coordinates for trebuchet. (Each value is positive.)

$$H = \frac{m\ell^2 \left(p_\theta^B - p_\phi^B \right)^2 + \left(MR^2 + mr^2 \right) \left(p_\phi^B \right)^2 - 2mr\ell p_\phi^B \left(p_\theta^B - p_\phi^B \right) \sin \phi_B}{m\ell^2 \left[MR^2 + mr^2 \cos^2 \phi_B \right]} - \left(MR - mr \right) g \sin \theta_B - mgl \cos \left(\phi_B + \theta_B \right)$$

(Assume zero-gravity)

For zero-gravity H is not a function of θ_B

so : $\dot{p}_\theta^B = \frac{\partial H}{\partial \theta_B} = 0$ and : $p_\theta^B = \Lambda = \text{const.}$

H is not an explicit function of t so : $H = \text{const.} = E$

$$H = \frac{m\ell^2 \left(\Lambda - p_\phi^B \right)^2 + \left(MR^2 + mr^2 \right) \left(p_\phi^B \right)^2 - 2mr\ell p_\phi^B \left(\Lambda - p_\phi^B \right) \sin \phi_B}{m\ell^2 \left[MR^2 + mr^2 \cos^2 \phi_B \right]} = \text{const.} = E$$

Rewrite $H=E$ as a quadratic equation in p_ϕ^B :

$$m\ell^2 \left(\Lambda^2 - 2\Lambda(p_\phi^B) + (p_\phi^B)^2 \right) + \left(MR^2 + mr^2 \right) (p_\phi^B)^2 - 2mr\ell(p_\phi^B) \left(\Lambda - p_\phi^B \right) \sin \phi_B = Em\ell^2 \left[MR^2 + mr^2 \cos^2 \phi_B \right]$$

$$m\ell^2 \Lambda^2 - 2m\ell^2 \Lambda(p_\phi^B) + \left(m\ell^2 + 2mr\ell \sin \phi_B + MR^2 + mr^2 \right) (p_\phi^B)^2 - 2mr\ell \Lambda \sin \phi_B (p_\phi^B) = Em\ell^2 \left[MR^2 + mr^2 \cos^2 \phi_B \right]$$

$$\left(m\ell^2 + 2mr\ell \sin \phi_B + MR^2 + mr^2 \right) (p_\phi^B)^2 - 2\Lambda \left(mr\ell \sin \phi_B + m\ell^2 \right) (p_\phi^B) + m\ell^2 \Lambda^2 - Em\ell^2 \left[MR^2 + mr^2 - mr^2 \sin^2 \phi_B \right] = 0$$

$$\left(1 + 2(r/\ell) \sin \phi_B + J \right) (p_\phi^B)^2 - 2\Lambda \left((r/\ell) \sin \phi_B + 1 \right) (p_\phi^B) + \Lambda^2 - E \left[I - mr^2 \sin^2 \phi_B \right] = 0 \quad \left(\text{using quadratic solution: } x = \frac{-b \pm \sqrt{b^2 - 4ac}}{2a} \right)$$

Throwing-momentum p_ϕ^B is a function of beam-relative angle ϕ_B , total E , and $\Lambda = p_\theta^B$.

$$p_\phi^B = \frac{2\Lambda \left((r/\ell) \sin \phi_B + 1 \right) \pm \sqrt{4\Lambda^2 \left((r/\ell) \sin \phi_B + 1 \right)^2 - 4 \left(1 + 2(r/\ell) \sin \phi_B + J \right) \left(\Lambda^2 - E \left[I - mr^2 \sin^2 \phi_B \right] \right)}}{2 \left(1 + 2(r/\ell) \sin \phi_B + J \right)} \quad \text{with: } J = \frac{MR^2 + mr^2}{m\ell^2}, \quad I = MR^2 + mr^2$$

Previous lab absolute trebuchet coordinate angles θ and ϕ

compared to

new angles θ_B and ϕ_B .

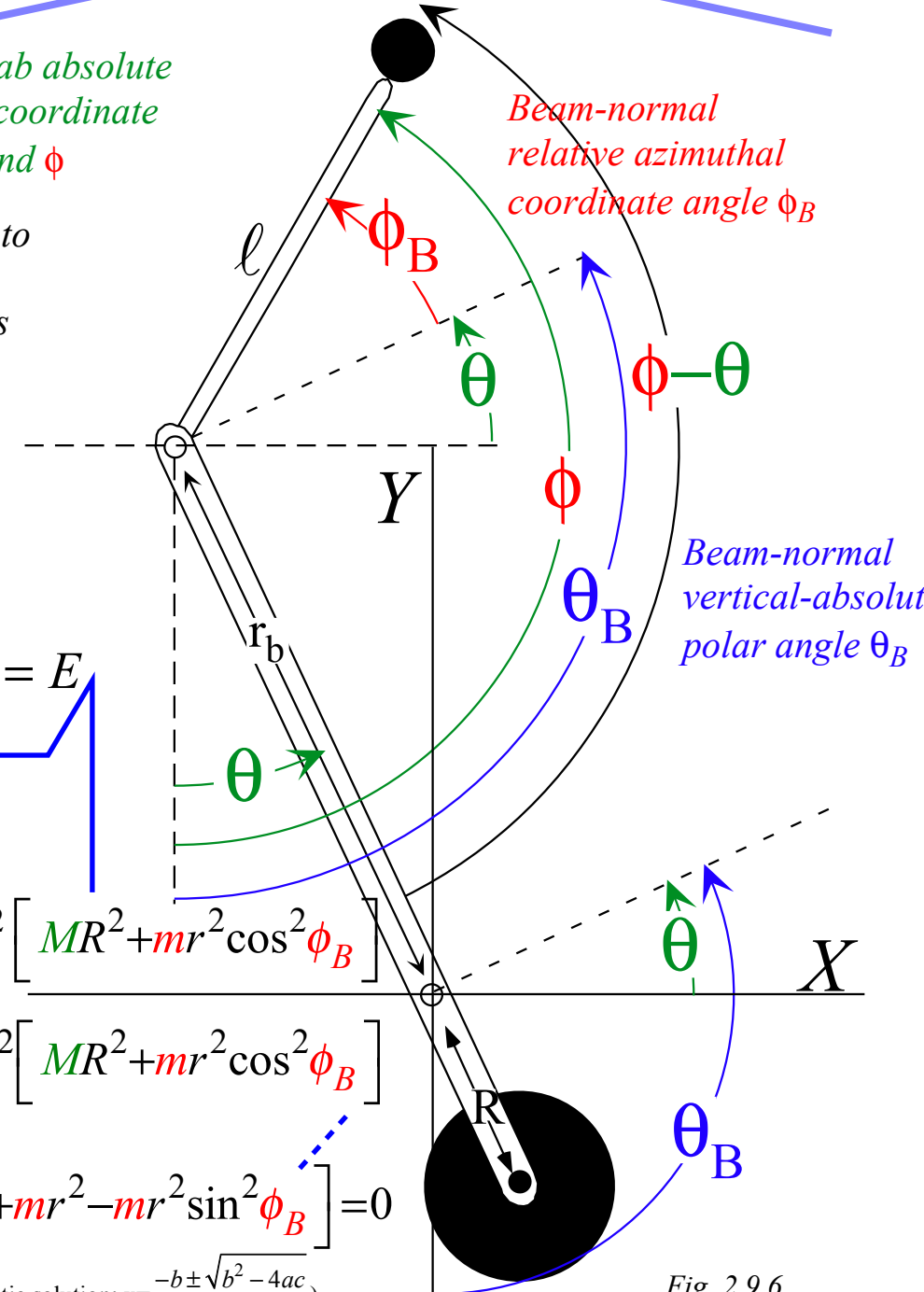



Fig. 2.9.6

Lab (θ, ϕ) and beam-normal (θ_B, ϕ_B) relative coordinates for trebuchet. (Each value is positive.)

Hamiltonian energy and momentum conservation and symmetry coordinates
Coordinate transformation helps reduce symmetric Hamiltonian
Free-space trebuchet kinematics by symmetry
Algebraic approach
 *Direct approach and Superball analogy*
Trebuchet vs Flinger and sports kinematics
Many approaches to Mechanics

Free-space trebuchet kinematics by symmetry: Direct approach and Superball analogy

Energy for zero-gravity

(Assume zero-gravity)

$$\text{Total KE} = T = \frac{1}{2} \left[(MR^2 + mr^2) \dot{\theta}^2 - 2mr\ell \cos(\theta - \phi) \dot{\theta} \dot{\phi} + m\ell^2 \dot{\phi}^2 \right]$$

$$p_{\theta} = \frac{\partial T}{\partial \dot{\theta}} = (MR^2 + mr^2) \dot{\theta} - mr\ell \dot{\phi} \cos(\theta - \phi)$$

$$p_{\phi} = \frac{\partial T}{\partial \dot{\phi}} = m\ell^2 \dot{\phi} - mr\ell \dot{\theta} \cos(\theta - \phi)$$

Previous lab absolute trebuchet coordinate angles θ and ϕ

compared to

new angles θ_B and ϕ_B .

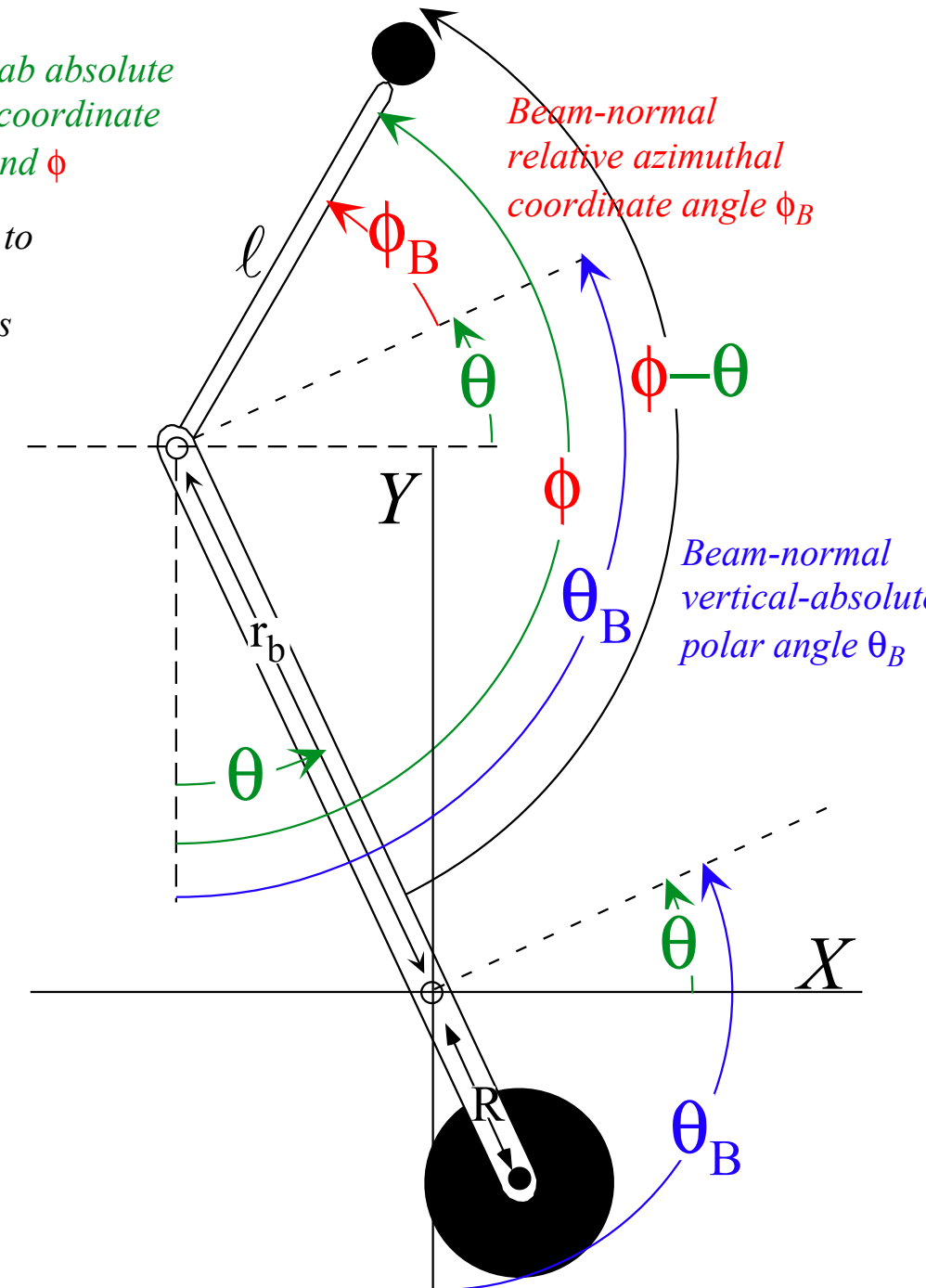

Free-space trebuchet kinematics by symmetry: Direct approach and Superball analogy

(Assume zero-gravity)

Energy for zero-gravity

$$\text{Total KE} = T = \frac{1}{2} \left[(MR^2 + mr^2) \dot{\theta}^2 - 2mrl \cos(\theta - \phi) \dot{\theta} \dot{\phi} + m\ell^2 \dot{\phi}^2 \right]$$

$$p_{\theta} = \frac{\partial T}{\partial \dot{\theta}} = (MR^2 + mr^2) \dot{\theta} - mrl \dot{\phi} \cos(\theta - \phi)$$

$$p_{\phi} = \frac{\partial T}{\partial \dot{\phi}} = m\ell^2 \dot{\phi} - mrl \dot{\theta} \cos(\theta - \phi)$$

Transform to beam-relative coordinates and momenta

$$\theta = \theta_B - \pi/2$$

$$\phi = \theta_B + \phi_B$$

$$\theta - \phi = -\phi_B - \pi/2$$

$$\theta_B = \theta + \pi/2$$

$$\phi_B = -\theta + \phi - \pi/2$$

$$p_{\theta} = p_{\theta}^B - p_{\phi}^B$$

$$p_{\phi} = p_{\phi}^B$$

Previous lab absolute trebuchet coordinate angles θ and ϕ

compared to

new angles θ_B and ϕ_B .

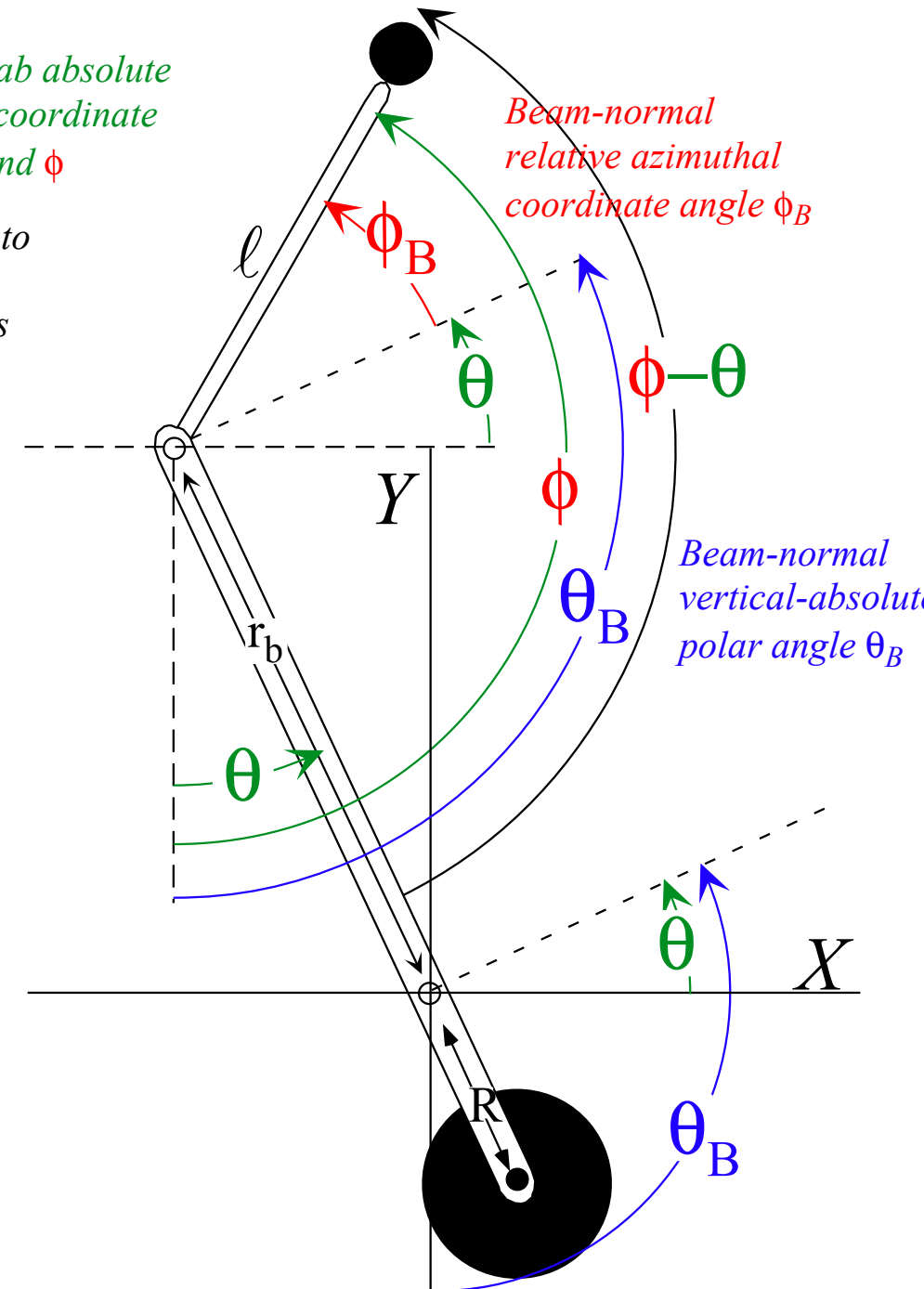

Free-space trebuchet kinematics by symmetry: Direct approach and Superball analogy

(Assume zero-gravity)

Energy for zero-gravity

$$\text{Total KE} = T = \frac{1}{2} \left[(MR^2 + mr^2) \dot{\theta}^2 - 2mr\ell \cos(\theta - \phi) \dot{\theta} \dot{\phi} + m\ell^2 \dot{\phi}^2 \right]$$

$$p_{\theta} = \frac{\partial T}{\partial \dot{\theta}} = (MR^2 + mr^2) \dot{\theta} - mr\ell \dot{\phi} \cos(\theta - \phi)$$

$$p_{\phi} = \frac{\partial T}{\partial \dot{\phi}} = m\ell^2 \dot{\phi} - mr\ell \dot{\theta} \cos(\theta - \phi)$$

Transform to beam-relative coordinates and momenta

$\theta = \theta_B - \pi/2$	$\theta_B = \theta + \pi/2$
$\phi = \theta_B + \phi_B$	$\phi_B = -\theta + \phi - \pi/2$
$\theta - \phi = -\phi_B - \pi/2$	

$$p_{\theta} = p_{\theta}^B - p_{\phi}^B$$

$$p_{\phi} = p_{\phi}^B$$

$$2E = (MR^2 + mr^2) \dot{\theta}^2 + 2mr\ell \dot{\phi} \dot{\theta} \sin \phi_B + m\ell^2 \dot{\phi}^2 = \text{const.}$$

Previous lab absolute trebuchet coordinate angles θ and ϕ

compared to

new angles θ_B and ϕ_B .

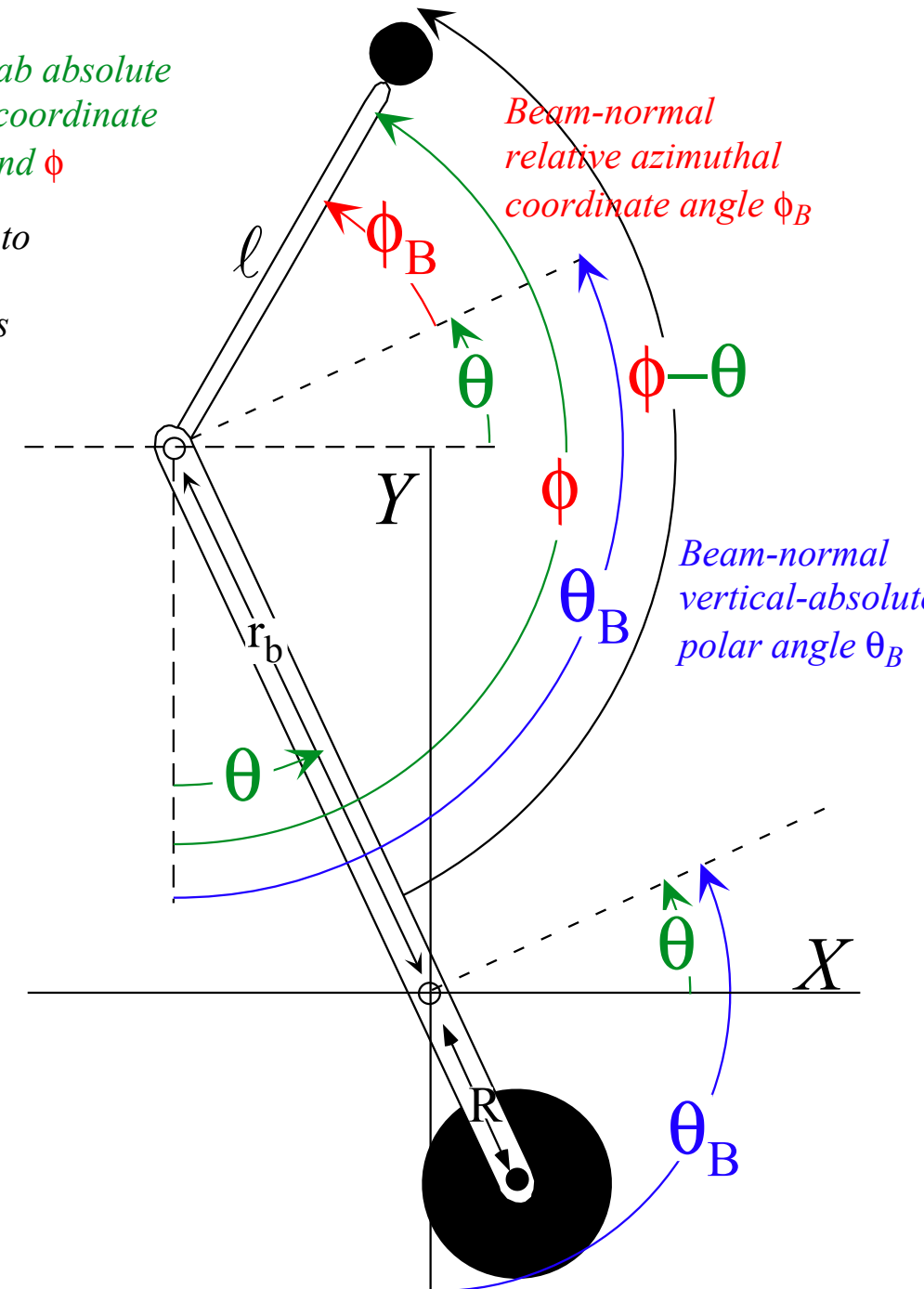

Free-space trebuchet kinematics by symmetry: Direct approach and Superball analogy

(Assume zero-gravity)

Energy for zero-gravity

$$\text{Total KE} = T = \frac{1}{2} \left[(MR^2 + mr^2) \dot{\theta}^2 - 2mrl \cos(\theta - \phi) \dot{\theta} \dot{\phi} + ml^2 \dot{\phi}^2 \right]$$

$$p_{\theta} = \frac{\partial T}{\partial \dot{\theta}} = (MR^2 + mr^2) \dot{\theta} - mrl \dot{\phi} \cos(\theta - \phi)$$

$$p_{\phi} = \frac{\partial T}{\partial \dot{\phi}} = ml^2 \dot{\phi} - mrl \dot{\theta} \cos(\theta - \phi)$$

Transform to beam-relative coordinates and momenta

$$\theta = \theta_B - \pi/2$$

$$\phi = \theta_B + \phi_B$$

$$\theta - \phi = -\phi_B - \pi/2$$

$$\theta_B = \theta + \pi/2$$

$$\phi_B = -\theta + \phi - \pi/2$$

$$p_{\theta} = p_{\theta}^B - p_{\phi}^B$$

$$p_{\phi} = p_{\phi}^B$$

$$2E = (MR^2 + mr^2) \dot{\theta}^2 + 2mrl \dot{\phi} \dot{\theta} \sin \phi_B + ml^2 \dot{\phi}^2 = \text{const.}$$

$$p_{\theta}^B = \Lambda = \text{const.} = p_{\theta} + p_{\phi}$$

$$= \left((MR^2 + mr^2) \dot{\theta} + mrl \dot{\phi} \sin \phi_B \right) + \left(ml^2 \dot{\phi} + mrl \dot{\theta} \sin \phi_B \right)$$

Previous lab absolute trebuchet coordinate angles θ and ϕ

compared to

new angles θ_B and ϕ_B .

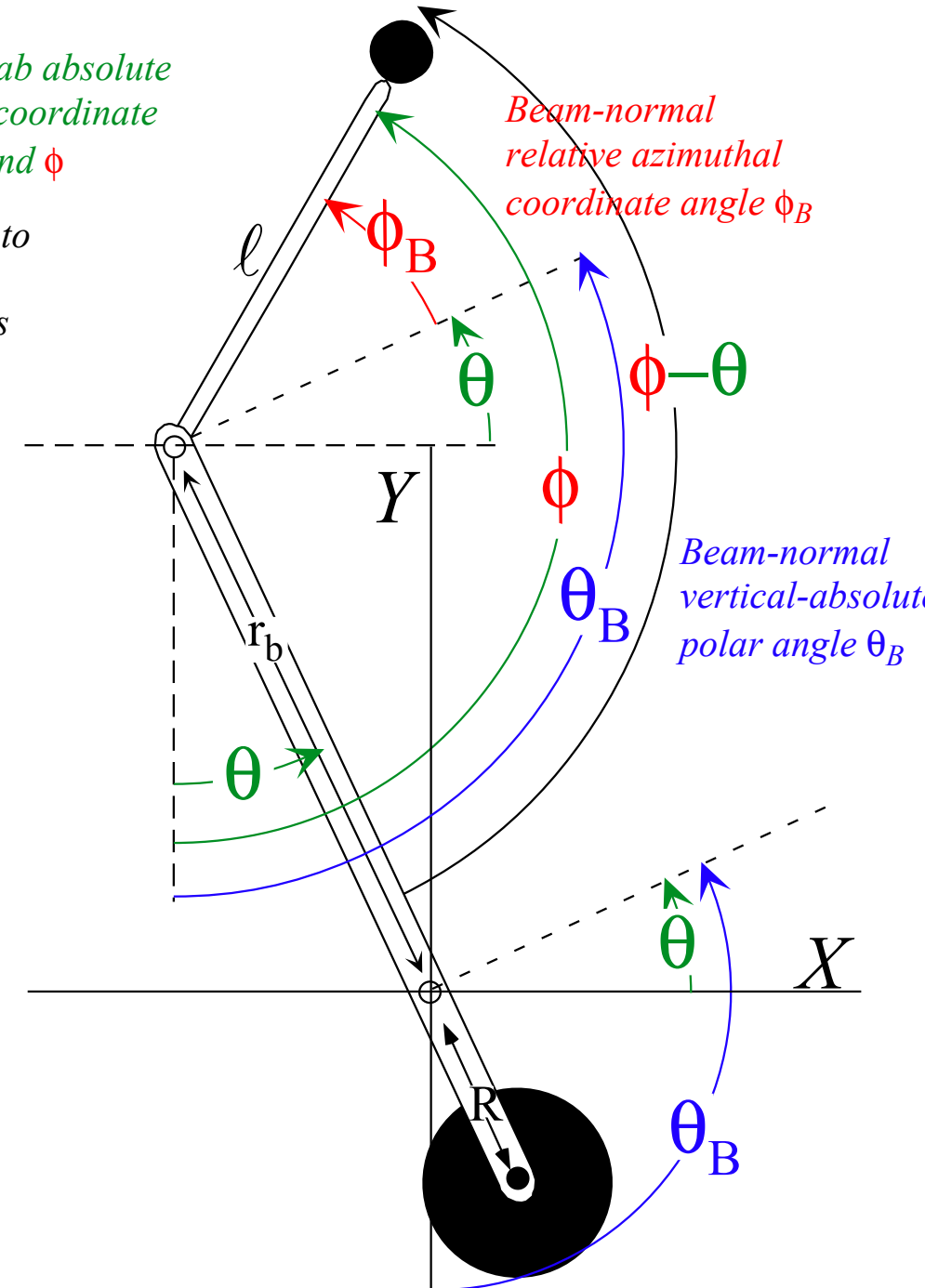

Free-space trebuchet kinematics by symmetry: Direct approach and Superball analogy

(Assume zero-gravity)

Energy for zero-gravity

$$\text{Total KE} = T = \frac{1}{2} \left[(MR^2 + mr^2) \dot{\theta}^2 - 2mr\ell \cos(\theta - \phi) \dot{\theta} \dot{\phi} + m\ell^2 \dot{\phi}^2 \right]$$

$$p_{\theta} = \frac{\partial T}{\partial \dot{\theta}} = (MR^2 + mr^2) \dot{\theta} - mr\ell \dot{\phi} \cos(\theta - \phi)$$

$$p_{\phi} = \frac{\partial T}{\partial \dot{\phi}} = m\ell^2 \dot{\phi} - mr\ell \dot{\theta} \cos(\theta - \phi)$$

Transform to beam-relative coordinates and momenta

$$\theta = \theta_B - \pi/2$$

$$\phi = \theta_B + \phi_B$$

$$\theta - \phi = -\phi_B - \pi/2$$

$$\theta_B = \theta + \pi/2$$

$$\phi_B = -\theta + \phi - \pi/2$$

$$p_{\theta} = p_{\theta}^B - p_{\phi}^B$$

$$p_{\phi} = p_{\phi}^B$$

$$2E = (MR^2 + mr^2) \dot{\theta}^2 + 2mr\ell \dot{\phi} \dot{\theta} \sin \phi_B + m\ell^2 \dot{\phi}^2 = \text{const.}$$

$$p_{\theta}^B = \Lambda = \text{const.} = p_{\theta} + p_{\phi}$$

$$= \left((MR^2 + mr^2) \dot{\theta} + mr\ell \dot{\phi} \sin \phi_B \right) + \left(m\ell^2 \dot{\phi} + mr\ell \dot{\theta} \sin \phi_B \right)$$

Case of equal arms $r = \ell$ (easier algebra)

$$\left. \begin{aligned} 2E &= MR^2 \dot{\theta}^2 + mr^2 \left(\dot{\theta}^2 + 2\dot{\phi} \dot{\theta} \sin \phi_B + \dot{\phi}^2 \right) \\ \Lambda &= MR^2 \dot{\theta} + mr^2 (1 + \sin \phi_B) (\dot{\theta} + \dot{\phi}) \end{aligned} \right\} \text{(For: } r = \ell)$$

Previous lab absolute trebuchet coordinate angles θ and ϕ

compared to

new angles θ_B and ϕ_B .

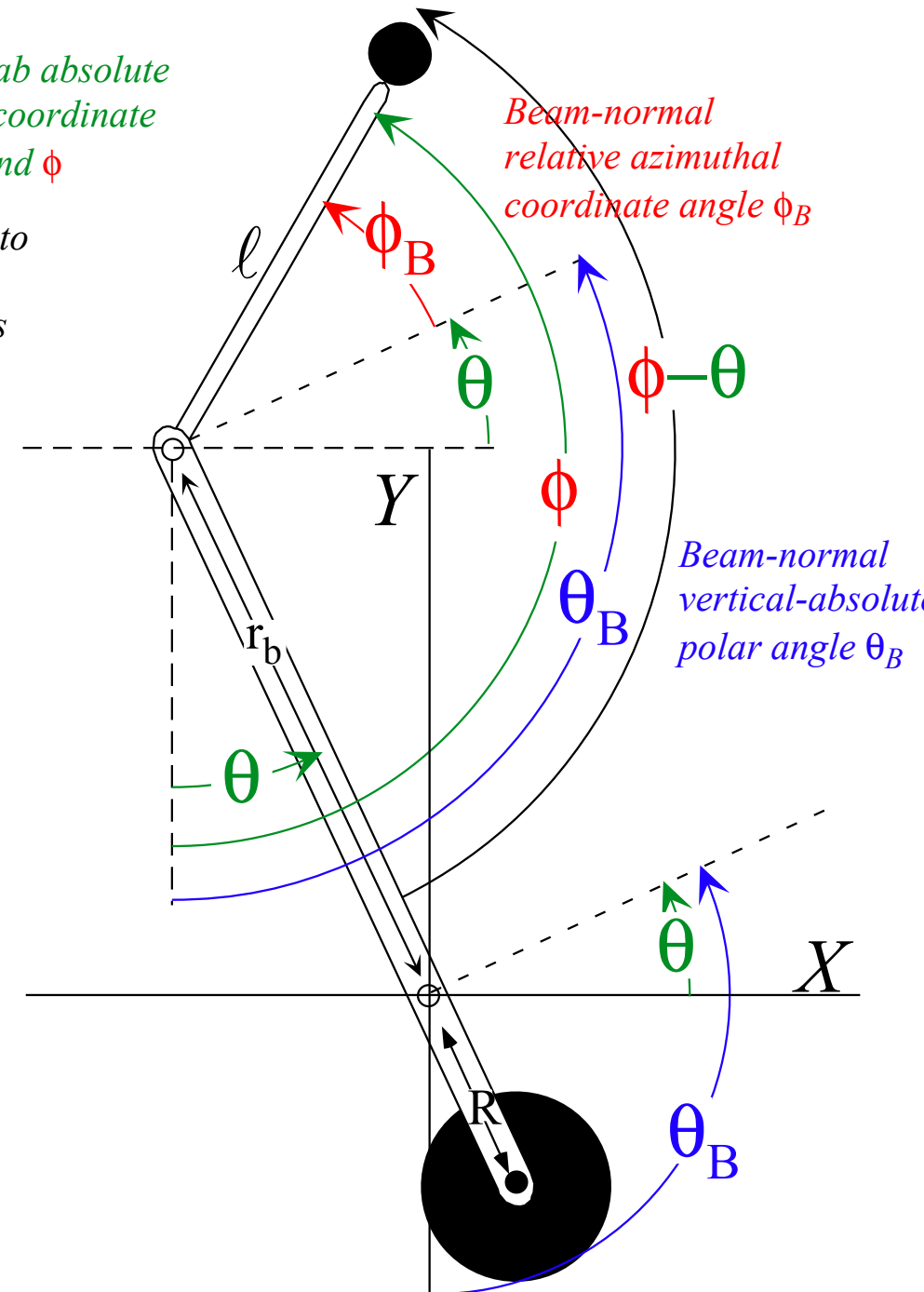

Free-space trebuchet kinematics by symmetry: Direct approach and Superball analogy

Case of equal arms $r = \ell$ (easier algebra)

$$\left. \begin{aligned} 2E &= MR^2\dot{\theta}^2 + mr^2(\dot{\theta}^2 + 2\dot{\phi}\dot{\theta}\sin\phi_B + \dot{\phi}^2) \\ \Lambda &= MR^2\dot{\theta} + mr^2(1 + \sin\phi_B)(\dot{\theta} + \dot{\phi}) \end{aligned} \right\} \begin{array}{l} \text{For:} \\ r = \ell \end{array}$$

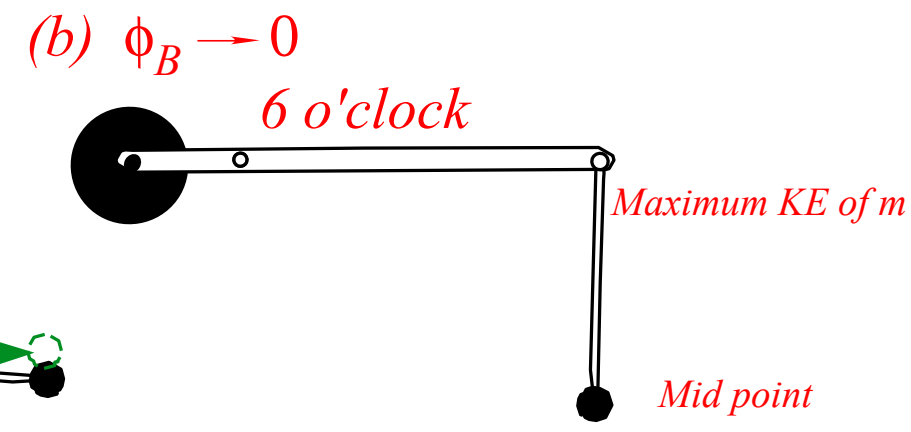
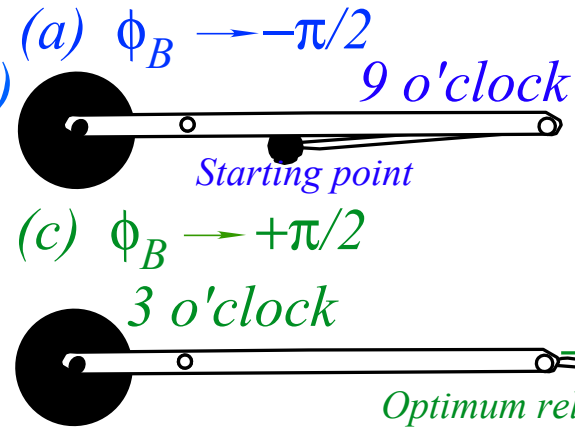

Free-space trebuchet kinematics by symmetry: Direct approach and Superball analogy

Case of equal arms $r = \ell$ (easier algebra)

$$\left. \begin{aligned} 2E &= MR^2 \dot{\theta}^2 + mr^2 (\dot{\theta}^2 + 2\dot{\phi}\dot{\theta} \sin \phi_B + \dot{\phi}^2) \\ \Lambda &= MR^2 \dot{\theta} + mr^2 (1 + \sin \phi_B) (\dot{\theta} + \dot{\phi}) \end{aligned} \right\} \text{For: } r = \ell$$

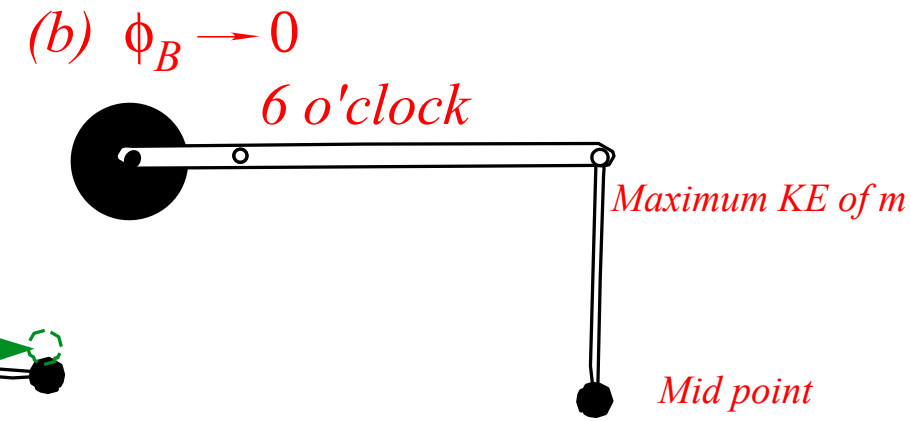
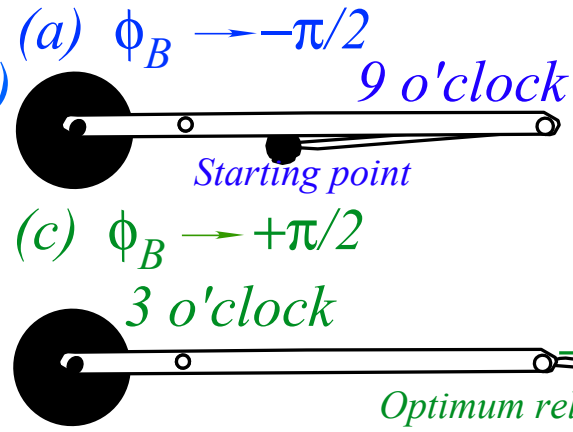

Start at 9 o'clock with $\phi_B \sim -90^\circ$ (beam r and throwing arm ℓ rotating together)

$$\left. \begin{aligned} \phi_B &= \frac{-\pi}{2} \\ \sin \phi_B &= -1 \end{aligned} \right\} \begin{cases} 2E = MR^2 \dot{\theta}_{-\pi/2}^2 + mr^2 (\dot{\phi}_{-\pi/2} - \dot{\theta}_{-\pi/2})^2 \\ \Lambda = MR^2 \dot{\theta}_{-\pi/2} \end{cases} \text{Conserved}$$

$$\text{or: } \begin{cases} \text{initial } 2E \\ 2E = MR^2 \omega^2 \\ \Lambda = MR^2 \omega \\ \text{initial } \Lambda \end{cases} \text{For: } \dot{\theta}_{-\pi/2} = \omega = \dot{\phi}_{-\pi/2}$$

Free-space trebuchet kinematics by symmetry: Direct approach and Superball analogy

Case of equal arms $r = \ell$ (easier algebra)

$$\left. \begin{aligned} 2E &= MR^2 \dot{\theta}^2 + mr^2 (\dot{\theta}^2 + 2\dot{\phi}\dot{\theta} \sin \phi_B + \dot{\phi}^2) \\ \Lambda &= MR^2 \dot{\theta} + mr^2 (1 + \sin \phi_B) (\dot{\theta} + \dot{\phi}) \end{aligned} \right\} \text{For: } r = \ell$$

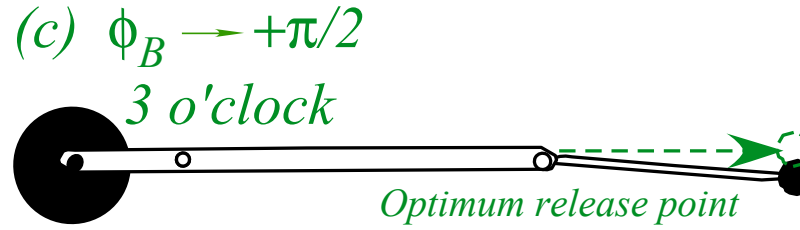
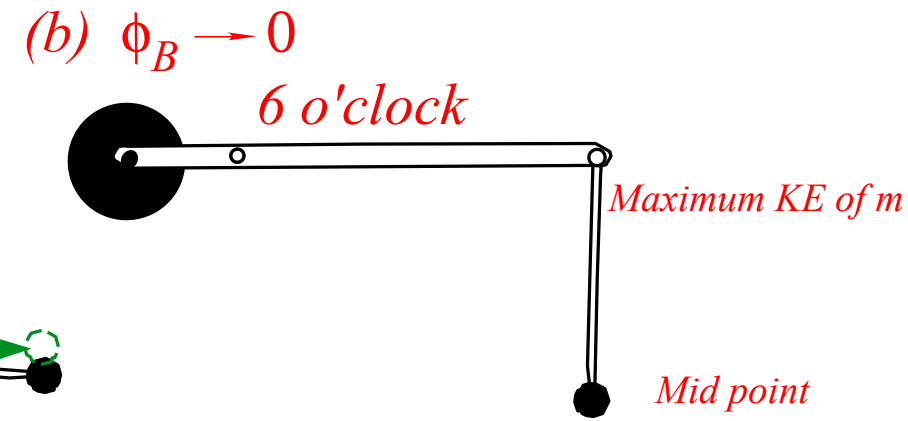
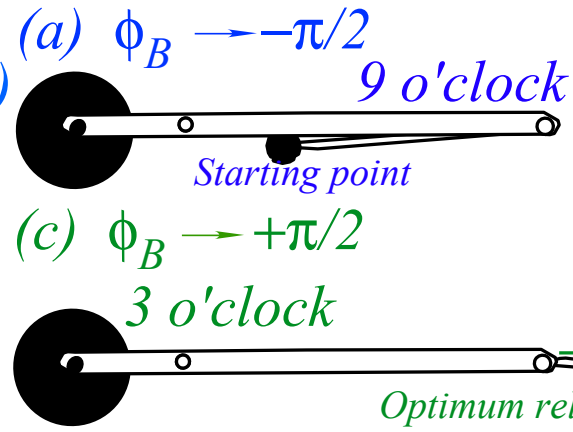

Start at 9 o'clock with $\phi_B \sim -90^\circ$ (beam r and throwing arm ℓ rotating together)

$$\left. \begin{aligned} \phi_B &= \frac{-\pi}{2} \\ \sin \phi_B &= -1 \end{aligned} \right\} \begin{cases} 2E = MR^2 \dot{\theta}_{-\pi/2}^2 + mr^2 (\dot{\phi}_{-\pi/2} - \dot{\theta}_{-\pi/2})^2 \\ \Lambda = MR^2 \dot{\theta}_{-\pi/2} \end{cases} \text{ or: } \begin{cases} \text{initial } 2E \\ 2E = MR^2 \omega^2 \\ \text{initial } \Lambda \\ \Lambda = MR^2 \omega \end{cases} \text{ For: } \dot{\theta}_{-\pi/2} = \omega = \dot{\phi}_{-\pi/2}$$

Conserved

Move to 6 o'clock with $\phi_B \sim 0^\circ$ (beam r slowing, throwing arm ℓ accelerating)

$$\left. \begin{aligned} \phi_B &= 0 \\ \sin \phi_B &= 0 \end{aligned} \right\} \begin{cases} 2E = MR^2 \dot{\theta}_0^2 + mr^2 (\dot{\phi}_0^2 + \dot{\theta}_0^2) \\ \Lambda = MR^2 \dot{\theta}_0 + mr^2 (\dot{\phi}_0 + \dot{\theta}_0) \end{cases}$$

Free-space trebuchet kinematics by symmetry: Direct approach and Superball analogy

Case of equal arms $r = \ell$ (easier algebra)

$$\left. \begin{aligned} 2E &= MR^2 \dot{\theta}^2 + mr^2 (\dot{\theta}^2 + 2\dot{\phi}\dot{\theta} \sin \phi_B + \dot{\phi}^2) \\ \Lambda &= MR^2 \dot{\theta} + mr^2 (1 + \sin \phi_B) (\dot{\theta} + \dot{\phi}) \end{aligned} \right\} \text{For: } r = \ell$$

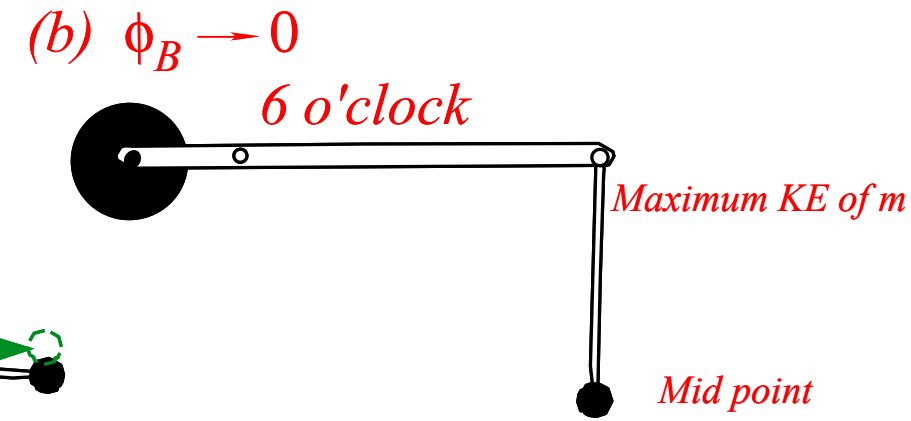
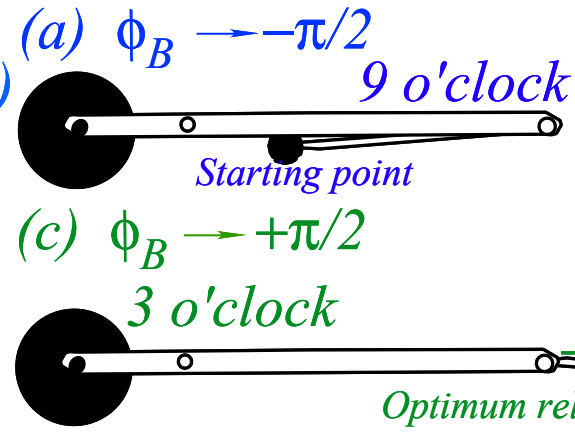

Start at 9 o'clock with $\phi_B \sim -90^\circ$ (beam r and throwing arm ℓ rotating together)

$$\left. \begin{aligned} \phi_B &= \frac{-\pi}{2} \\ \sin \phi_B &= -1 \end{aligned} \right\} \begin{cases} 2E = MR^2 \dot{\theta}_{-\pi/2}^2 + mr^2 (\dot{\phi}_{-\pi/2} - \dot{\theta}_{-\pi/2})^2 \\ \Lambda = MR^2 \dot{\theta}_{-\pi/2} \end{cases} \text{Conserved} \quad \text{or: } \begin{cases} \text{initial } 2E \\ 2E = MR^2 \omega^2 \\ \Lambda = MR^2 \omega \\ \text{initial } \Lambda \end{cases} \quad \text{For: } \dot{\theta}_{-\pi/2} = \omega = \dot{\phi}_{-\pi/2}$$

Move to 6 o'clock with $\phi_B \sim 0^\circ$ (beam r slowing, throwing arm ℓ accelerating)

$$\left. \begin{aligned} \phi_B &= 0 \\ \sin \phi_B &= 0 \end{aligned} \right\} \begin{cases} 2E = MR^2 \dot{\theta}_0^2 + mr^2 (\dot{\phi}_0^2 + \dot{\theta}_0^2) \\ \Lambda = MR^2 \dot{\theta}_0 + mr^2 (\dot{\phi}_0 + \dot{\theta}_0) \end{cases}$$

Move to 3 o'clock with $\phi_B \sim +90^\circ$ (beam r slowed, throwing arm ℓ releasing)

$$\left. \begin{aligned} \phi_B &= \pi/2 \\ \sin \phi_B &= +1 \end{aligned} \right\} \begin{cases} 2E = MR^2 \dot{\theta}_{\pi/2}^2 + mr^2 (\dot{\phi}_{\pi/2} + \dot{\theta}_{\pi/2})^2 = \text{initial } 2E \\ \Lambda = MR^2 \dot{\theta}_{\pi/2} + 2mr^2 (\dot{\phi}_{\pi/2} + \dot{\theta}_{\pi/2}) = \text{initial } \Lambda \end{cases} \text{Conserved}$$

Free-space trebuchet kinematics by symmetry: Direct approach and Superball analogy

Case of equal arms $r = \ell$ (easier algebra)

$$\left. \begin{aligned} 2E &= MR^2 \dot{\theta}^2 + mr^2 (\dot{\theta}^2 + 2\dot{\phi}\dot{\theta} \sin \phi_B + \dot{\phi}^2) \\ \Lambda &= MR^2 \dot{\theta} + mr^2 (1 + \sin \phi_B) (\dot{\theta} + \dot{\phi}) \end{aligned} \right\} \text{For: } r = \ell$$

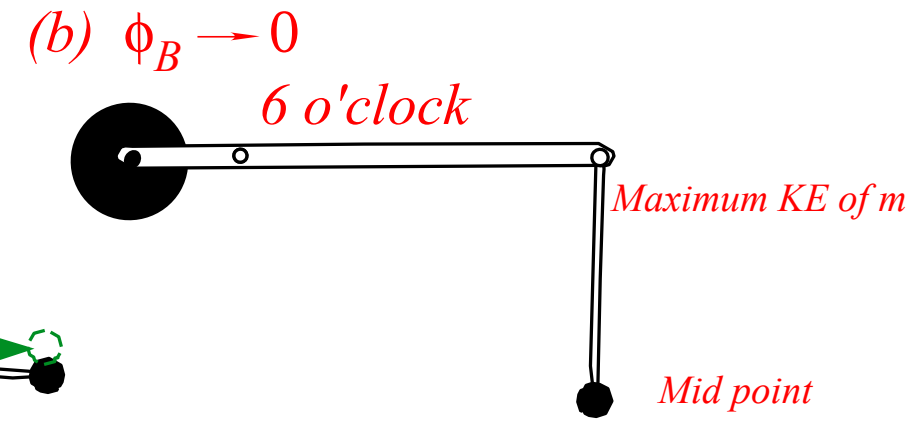
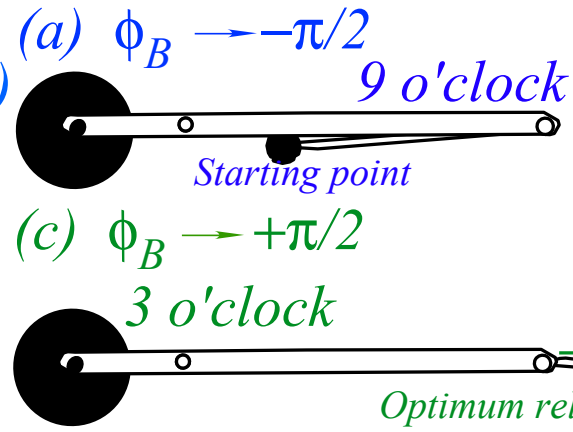

Start at 9 o'clock with $\phi_B \sim -90^\circ$ (beam r and throwing arm ℓ rotating together)

$$\left. \begin{aligned} \phi_B &= \frac{-\pi}{2} \\ \sin \phi_B &= -1 \end{aligned} \right\} \begin{cases} 2E = MR^2 \dot{\theta}_{-\pi/2}^2 + mr^2 (\dot{\phi}_{-\pi/2} - \dot{\theta}_{-\pi/2})^2 \\ \Lambda = MR^2 \dot{\theta}_{-\pi/2} \end{cases} \text{Conserved} \quad \text{or: } \begin{cases} \text{initial } 2E \\ 2E = MR^2 \omega^2 \\ \Lambda = MR^2 \omega \\ \text{initial } \Lambda \end{cases} \quad \text{For: } \dot{\theta}_{-\pi/2} = \omega = \dot{\phi}_{-\pi/2}$$

Move to 6 o'clock with $\phi_B \sim 0^\circ$ (beam r slowing, throwing arm ℓ accelerating)

$$\left. \begin{aligned} \phi_B &= 0 \\ \sin \phi_B &= 0 \end{aligned} \right\} \begin{cases} 2E = MR^2 \dot{\theta}_0^2 + mr^2 (\dot{\phi}_0^2 + \dot{\theta}_0^2) \\ \Lambda = MR^2 \dot{\theta}_0 + mr^2 (\dot{\phi}_0 + \dot{\theta}_0) \end{cases}$$

Move to 3 o'clock with $\phi_B \sim +90^\circ$ (beam r slowed, throwing arm ℓ releasing)

$$\left. \begin{aligned} \phi_B &= \pi/2 \\ \sin \phi_B &= +1 \end{aligned} \right\} \begin{cases} 2E = MR^2 \dot{\theta}_{\pi/2}^2 + mr^2 (\dot{\phi}_{\pi/2} + \dot{\theta}_{\pi/2})^2 \\ \Lambda = MR^2 \dot{\theta}_{\pi/2} + 2mr^2 (\dot{\phi}_{\pi/2} + \dot{\theta}_{\pi/2}) \end{cases} \text{Conserved} \quad \begin{aligned} \text{initial } 2E &= MR^2 \omega^2 \\ \text{initial } \Lambda &= MR^2 \omega \end{aligned}$$

$$KE(m) = \frac{mr^2}{2} (\dot{\phi}^2 + \dot{\theta}^2 + 2\dot{\phi}\dot{\theta} \sin \phi_B) = \begin{cases} \frac{mr^2}{2} (\dot{\phi} - \dot{\theta})^2 & \left(\text{For: } \phi_B = -\frac{\pi}{2} \right) \\ \frac{mr^2}{2} (\dot{\phi}^2 + \dot{\theta}^2) & \left(\text{For: } \phi_B = 0 \right) \\ \frac{mr^2}{2} (\dot{\phi} + \dot{\theta})^2 & \left(\text{For: } \phi_B = \frac{\pi}{2} \right) \end{cases}$$

Free-space trebuchet kinematics by symmetry: Direct approach and Superball analogy

Case of equal arms $r = \ell$ (easier algebra)

$$\left. \begin{aligned} 2E &= MR^2 \dot{\theta}^2 + mr^2 (\dot{\theta}^2 + 2\dot{\phi}\dot{\theta} \sin \phi_B + \dot{\phi}^2) \\ \Lambda &= MR^2 \dot{\theta} + mr^2 (1 + \sin \phi_B) (\dot{\theta} + \dot{\phi}) \end{aligned} \right\} \text{For: } r = \ell$$

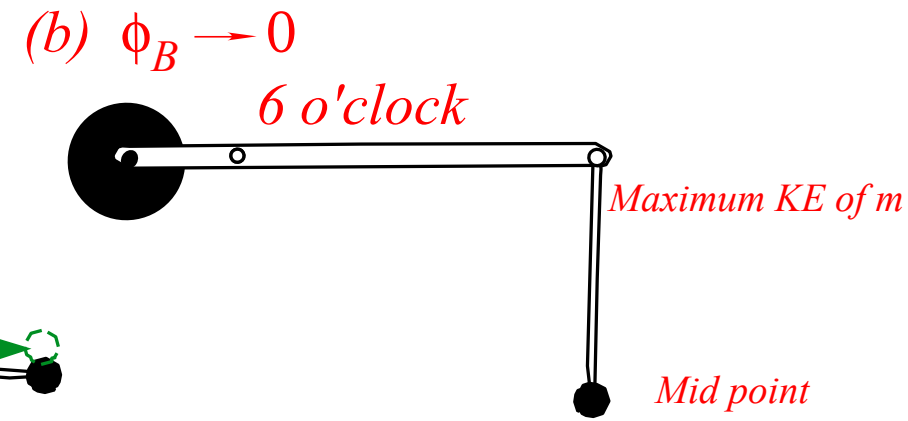
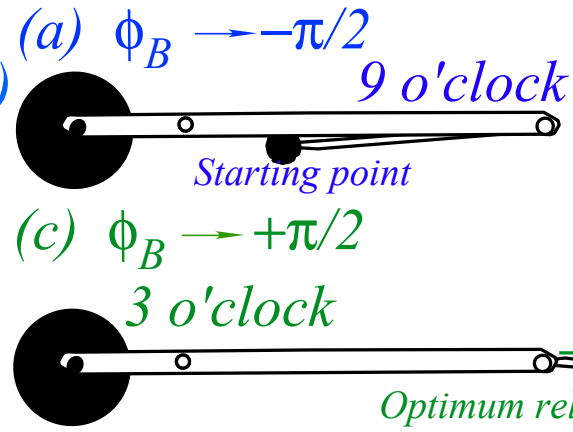

Start at 9 o'clock with $\phi_B \sim -90^\circ$ (beam r and throwing arm ℓ rotating together)

$$\left. \begin{aligned} \phi_B &= \frac{-\pi}{2} \\ \sin \phi_B &= -1 \end{aligned} \right\} \begin{cases} 2E = MR^2 \dot{\theta}_{-\pi/2}^2 + mr^2 (\dot{\phi}_{-\pi/2} - \dot{\theta}_{-\pi/2})^2 \\ \Lambda = MR^2 \dot{\theta}_{-\pi/2} \end{cases} \text{Conserved} \quad \text{or: } \begin{cases} \text{initial } 2E \\ 2E = MR^2 \omega^2 \\ \Lambda = MR^2 \omega \\ \text{initial } \Lambda \end{cases} \quad \text{For: } \dot{\theta}_{-\pi/2} = \omega = \dot{\phi}_{-\pi/2}$$

Move to 6 o'clock with $\phi_B \sim 0^\circ$ (beam r slowing, throwing arm ℓ accelerating)

$$\left. \begin{aligned} \phi_B &= 0 \\ \sin \phi_B &= 0 \end{aligned} \right\} \begin{cases} 2E = MR^2 \dot{\theta}_0^2 + mr^2 (\dot{\phi}_0^2 + \dot{\theta}_0^2) \\ \Lambda = MR^2 \dot{\theta}_0 + mr^2 (\dot{\phi}_0 + \dot{\theta}_0) \end{cases}$$

Move to 3 o'clock with $\phi_B \sim +90^\circ$ (beam r slowed, throwing arm ℓ releasing)

$$\left. \begin{aligned} \phi_B &= \pi/2 \\ \sin \phi_B &= +1 \end{aligned} \right\} \begin{cases} 2E = MR^2 \dot{\theta}_{\pi/2}^2 + mr^2 (\dot{\phi}_{\pi/2} + \dot{\theta}_{\pi/2})^2 \\ \Lambda = MR^2 \dot{\theta}_{\pi/2} + 2mr^2 (\dot{\phi}_{\pi/2} + \dot{\theta}_{\pi/2}) \end{cases} \text{Conserved} \quad \begin{aligned} \text{initial } 2E &= MR^2 \omega^2 \longrightarrow (\omega^2 - \dot{\theta}_{\pi/2}^2) = \frac{mr^2}{MR^2} (\dot{\phi}_{\pi/2} + \dot{\theta}_{\pi/2})^2 \\ \text{initial } \Lambda &= MR^2 \omega \longrightarrow (\omega - \dot{\theta}_{\pi/2}) = \frac{2mr^2}{MR^2} (\dot{\phi}_{\pi/2} + \dot{\theta}_{\pi/2}) \end{aligned}$$

$$KE(m) = \frac{mr^2}{2} (\dot{\phi}^2 + \dot{\theta}^2 + 2\dot{\phi}\dot{\theta} \sin \phi_B) = \begin{cases} \frac{mr^2}{2} (\dot{\phi} - \dot{\theta})^2 & \left(\text{For: } \phi_B = -\frac{\pi}{2} \right) \\ \frac{mr^2}{2} (\dot{\phi}^2 + \dot{\theta}^2) & \left(\text{For: } \phi_B = 0 \right) \\ \frac{mr^2}{2} (\dot{\phi} + \dot{\theta})^2 & \left(\text{For: } \phi_B = \frac{\pi}{2} \right) \end{cases}$$

Free-space trebuchet kinematics by symmetry: Direct approach and Superball analogy

Case of equal arms $r = \ell$ (easier algebra)

$$\left. \begin{aligned} 2E &= MR^2 \dot{\theta}^2 + mr^2 (\dot{\theta}^2 + 2\dot{\phi}\dot{\theta} \sin \phi_B + \dot{\phi}^2) \\ \Lambda &= MR^2 \dot{\theta} + mr^2 (1 + \sin \phi_B) (\dot{\theta} + \dot{\phi}) \end{aligned} \right\} \text{For: } r = \ell$$

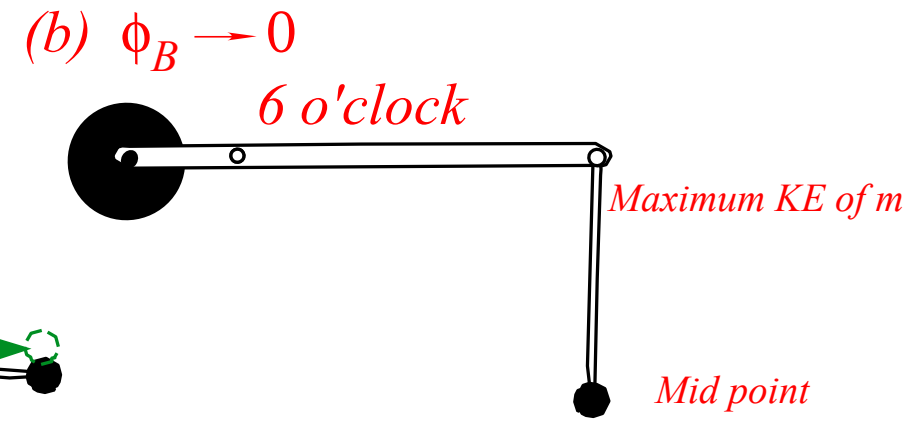
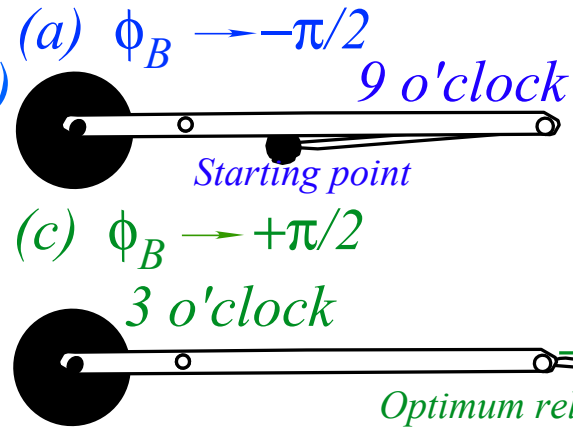

Start at 9 o'clock with $\phi_B \sim -90^\circ$ (beam r and throwing arm ℓ rotating together)

$$\left. \begin{aligned} \phi_B &= \frac{-\pi}{2} \\ \sin \phi_B &= -1 \end{aligned} \right\} \begin{cases} 2E = MR^2 \dot{\theta}_{-\pi/2}^2 + mr^2 (\dot{\phi}_{-\pi/2} - \dot{\theta}_{-\pi/2})^2 \\ \Lambda = MR^2 \dot{\theta}_{-\pi/2} \end{cases} \text{Conserved} \quad \text{or: } \begin{cases} \text{initial } 2E \\ 2E = MR^2 \omega^2 \\ \Lambda = MR^2 \omega \\ \text{initial } \Lambda \end{cases} \quad \text{For: } \dot{\theta}_{-\pi/2} = \omega = \dot{\phi}_{-\pi/2}$$

Move to 6 o'clock with $\phi_B \sim 0^\circ$ (beam r slowing, throwing arm ℓ accelerating)

$$\left. \begin{aligned} \phi_B &= 0 \\ \sin \phi_B &= 0 \end{aligned} \right\} \begin{cases} 2E = MR^2 \dot{\theta}_0^2 + mr^2 (\dot{\phi}_0^2 + \dot{\theta}_0^2) \\ \Lambda = MR^2 \dot{\theta}_0 + mr^2 (\dot{\phi}_0 + \dot{\theta}_0) \end{cases}$$

Move to 3 o'clock with $\phi_B \sim +90^\circ$ (beam r slowed, throwing arm ℓ releasing)

$$\left. \begin{aligned} \phi_B &= \pi/2 \\ \sin \phi_B &= +1 \end{aligned} \right\} \begin{cases} 2E = MR^2 \dot{\theta}_{\pi/2}^2 + mr^2 (\dot{\phi}_{\pi/2} + \dot{\theta}_{\pi/2})^2 \\ \Lambda = MR^2 \dot{\theta}_{\pi/2} + 2mr^2 (\dot{\phi}_{\pi/2} + \dot{\theta}_{\pi/2}) \end{cases} \text{Conserved} \quad \begin{aligned} \text{initial } 2E &= MR^2 \omega^2 \longrightarrow (\omega^2 - \dot{\theta}_{\pi/2}^2) = \frac{mr^2}{MR^2} (\dot{\phi}_{\pi/2} + \dot{\theta}_{\pi/2})^2 \\ \text{initial } \Lambda &= MR^2 \omega \longrightarrow (\omega - \dot{\theta}_{\pi/2}) = \frac{2mr^2}{MR^2} (\dot{\phi}_{\pi/2} + \dot{\theta}_{\pi/2}) \end{aligned} \longrightarrow (\omega + \dot{\theta}_{\pi/2}) = \frac{1}{2} (\dot{\phi}_{\pi/2} + \dot{\theta}_{\pi/2})$$

$$KE(m) = \frac{mr^2}{2} (\dot{\phi}^2 + \dot{\theta}^2 + 2\dot{\phi}\dot{\theta} \sin \phi_B) = \begin{cases} \frac{mr^2}{2} (\dot{\phi} - \dot{\theta})^2 & \left(\text{For: } \phi_B = -\frac{\pi}{2} \right) \\ \frac{mr^2}{2} (\dot{\phi}^2 + \dot{\theta}^2) & \left(\text{For: } \phi_B = 0 \right) \\ \frac{mr^2}{2} (\dot{\phi} + \dot{\theta})^2 & \left(\text{For: } \phi_B = \frac{\pi}{2} \right) \end{cases}$$

Free-space trebuchet kinematics by symmetry: Direct approach and Superball analogy

Case of equal arms $r = \ell$ (easier algebra)

$$\left. \begin{aligned} 2E &= MR^2 \dot{\theta}^2 + mr^2 (\dot{\theta}^2 + 2\dot{\phi}\dot{\theta} \sin \phi_B + \dot{\phi}^2) \\ \Lambda &= MR^2 \dot{\theta} + mr^2 (1 + \sin \phi_B) (\dot{\theta} + \dot{\phi}) \end{aligned} \right\} \text{For: } r = \ell$$

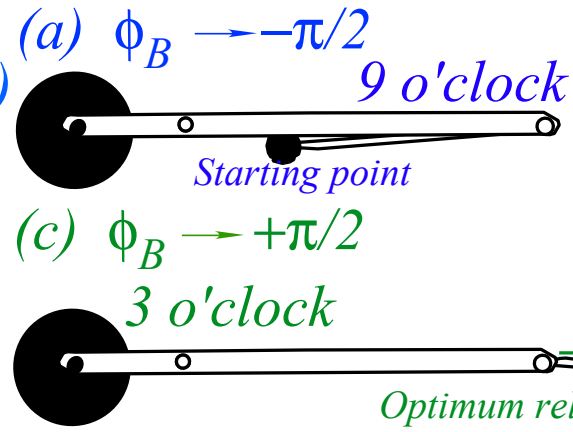

Start at 9 o'clock with $\phi_B \sim -90^\circ$ (beam r and throwing arm ℓ rotating together)

$$\left. \begin{aligned} \phi_B &= \frac{-\pi}{2} \\ \sin \phi_B &= -1 \end{aligned} \right\} \begin{cases} 2E = MR^2 \dot{\theta}_{-\pi/2}^2 + mr^2 (\dot{\phi}_{-\pi/2} - \dot{\theta}_{-\pi/2})^2 \\ \Lambda = MR^2 \dot{\theta}_{-\pi/2} \end{cases} \text{Conserved}$$

or: $\begin{cases} \text{initial } 2E \\ 2E = MR^2 \omega^2 \\ \Lambda = MR^2 \omega \\ \text{initial } \Lambda \end{cases}$ For: $\dot{\theta}_{-\pi/2} = \omega = \dot{\phi}_{-\pi/2}$

Move to 6 o'clock with $\phi_B \sim 0^\circ$ (beam r slowing, throwing arm ℓ accelerating)

$$\left. \begin{aligned} \phi_B &= 0 \\ \sin \phi_B &= 0 \end{aligned} \right\} \begin{cases} 2E = MR^2 \dot{\theta}_0^2 + mr^2 (\dot{\phi}_0^2 + \dot{\theta}_0^2) \\ \Lambda = MR^2 \dot{\theta}_0 + mr^2 (\dot{\phi}_0 + \dot{\theta}_0) \end{cases}$$

Move to 3 o'clock with $\phi_B \sim +90^\circ$ (beam r slowed, throwing arm ℓ releasing)

$$\left. \begin{aligned} \phi_B &= \pi/2 \\ \sin \phi_B &= +1 \end{aligned} \right\} \begin{cases} 2E = MR^2 \dot{\theta}_{\pi/2}^2 + mr^2 (\dot{\phi}_{\pi/2} + \dot{\theta}_{\pi/2})^2 \\ \Lambda = MR^2 \dot{\theta}_{\pi/2} + 2mr^2 (\dot{\phi}_{\pi/2} + \dot{\theta}_{\pi/2}) \end{cases} \text{Conserved}$$

initial $2E = MR^2 \omega^2$ $\rightarrow (\omega^2 - \dot{\theta}_{\pi/2}^2) = \frac{mr^2}{MR^2} (\dot{\phi}_{\pi/2} + \dot{\theta}_{\pi/2})^2$ *divide 2E*

initial $\Lambda = MR^2 \omega$ $\rightarrow (\omega - \dot{\theta}_{\pi/2}) = \frac{2mr^2}{MR^2} (\dot{\phi}_{\pi/2} + \dot{\theta}_{\pi/2})$ *by \Lambda*

$(\omega + \dot{\theta}_{\pi/2}) = \frac{1}{2} (\dot{\phi}_{\pi/2} + \dot{\theta}_{\pi/2})$

$\dot{\phi}_{\pi/2} = \dot{\theta}_{\pi/2} + 2\omega$

$$KE(m) = \frac{mr^2}{2} (\dot{\phi}^2 + \dot{\theta}^2 + 2\dot{\phi}\dot{\theta} \sin \phi_B)$$

$$= \begin{cases} \frac{mr^2}{2} (\dot{\phi} - \dot{\theta})^2 & \left(\text{For: } \phi_B = -\frac{\pi}{2} \right) \\ \frac{mr^2}{2} (\dot{\phi}^2 + \dot{\theta}^2) & \left(\text{For: } \phi_B = 0 \right) \\ \frac{mr^2}{2} (\dot{\phi} + \dot{\theta})^2 & \left(\text{For: } \phi_B = \frac{\pi}{2} \right) \end{cases}$$

Free-space trebuchet kinematics by symmetry: Direct approach and Superball analogy

Case of equal arms $r = \ell$ (easier algebra)

$$\left. \begin{aligned} 2E &= MR^2 \dot{\theta}^2 + mr^2 (\dot{\theta}^2 + 2\dot{\phi}\dot{\theta} \sin \phi_B + \dot{\phi}^2) \\ \Lambda &= MR^2 \dot{\theta} + mr^2 (1 + \sin \phi_B) (\dot{\theta} + \dot{\phi}) \end{aligned} \right\} \text{For: } r = \ell$$

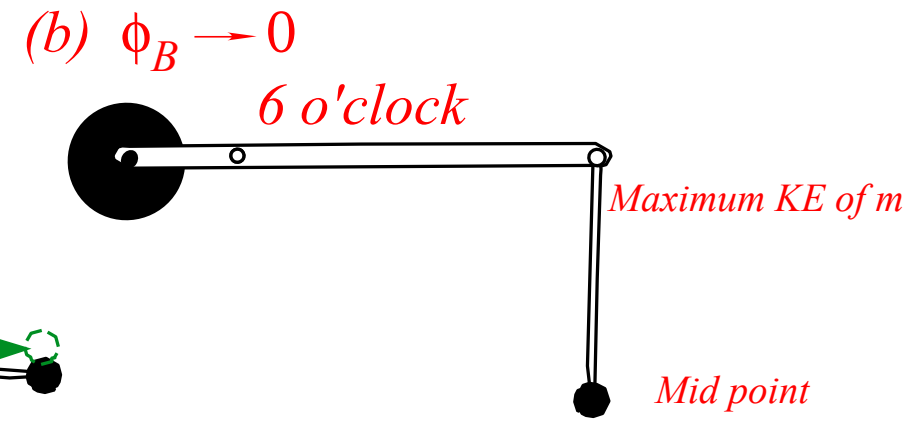
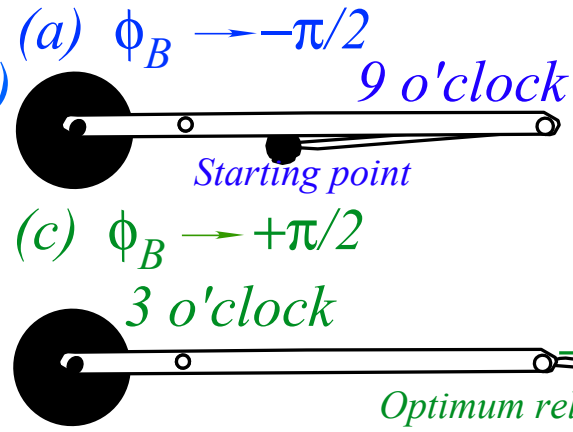

Start at 9 o'clock with $\phi_B \sim -90^\circ$ (beam r and throwing arm ℓ rotating together)

$$\left. \begin{aligned} \phi_B &= \frac{-\pi}{2} \\ \sin \phi_B &= -1 \end{aligned} \right\} \begin{cases} 2E = MR^2 \dot{\theta}_{-\pi/2}^2 + mr^2 (\dot{\phi}_{-\pi/2} - \dot{\theta}_{-\pi/2})^2 \\ \Lambda = MR^2 \dot{\theta}_{-\pi/2} \end{cases} \text{ or: } \begin{cases} \text{initial } 2E \\ 2E = MR^2 \omega^2 \\ \Lambda = MR^2 \omega \\ \text{initial } \Lambda \end{cases} \text{ For: } \dot{\theta}_{-\pi/2} = \omega = \dot{\phi}_{-\pi/2}$$

Move to 6 o'clock with $\phi_B \sim 0^\circ$ (beam r slowing, throwing arm ℓ accelerating)

$$\left. \begin{aligned} \phi_B &= 0 \\ \sin \phi_B &= 0 \end{aligned} \right\} \begin{cases} 2E = MR^2 \dot{\theta}_0^2 + mr^2 (\dot{\phi}_0^2 + \dot{\theta}_0^2) \\ \Lambda = MR^2 \dot{\theta}_0 + mr^2 (\dot{\phi}_0 + \dot{\theta}_0) \end{cases}$$

$$KE(m) = \frac{mr^2}{2} (\dot{\phi}^2 + \dot{\theta}^2 + 2\dot{\phi}\dot{\theta} \sin \phi_B) = \begin{cases} \frac{mr^2}{2} (\dot{\phi} - \dot{\theta})^2 & \left(\text{For: } \phi_B = -\frac{\pi}{2} \right) \\ \frac{mr^2}{2} (\dot{\phi}^2 + \dot{\theta}^2) & \left(\text{For: } \phi_B = 0 \right) \\ \frac{mr^2}{2} (\dot{\phi} + \dot{\theta})^2 & \left(\text{For: } \phi_B = \frac{\pi}{2} \right) \end{cases}$$

Move to 3 o'clock with $\phi_B \sim +90^\circ$ (beam r slowed, throwing arm ℓ releasing)

$$\left. \begin{aligned} \phi_B &= \pi/2 \\ \sin \phi_B &= +1 \end{aligned} \right\} \begin{cases} 2E = MR^2 \dot{\theta}_{\pi/2}^2 + mr^2 (\dot{\phi}_{\pi/2} + \dot{\theta}_{\pi/2})^2 \\ \Lambda = MR^2 \dot{\theta}_{\pi/2} + 2mr^2 (\dot{\phi}_{\pi/2} + \dot{\theta}_{\pi/2}) \end{cases} \begin{array}{l} \text{Conserved} \\ \text{initial } 2E \\ = MR^2 \omega^2 \end{array} \begin{array}{l} \xrightarrow{\text{divide } 2E} \\ (\omega^2 - \dot{\theta}_{\pi/2}^2) = \frac{mr^2}{MR^2} (\dot{\phi}_{\pi/2} + \dot{\theta}_{\pi/2})^2 \\ \xrightarrow{\text{by } \Lambda} \\ (\omega - \dot{\theta}_{\pi/2}) = \frac{2mr^2}{MR^2} (\dot{\phi}_{\pi/2} + \dot{\theta}_{\pi/2}) \end{array} \begin{array}{l} \xrightarrow{\text{divide } 2E} \\ (\omega + \dot{\theta}_{\pi/2}) = \frac{1}{2} (\dot{\phi}_{\pi/2} + \dot{\theta}_{\pi/2}) \\ \xrightarrow{\text{by } \Lambda} \\ \dot{\phi}_{\pi/2} = \dot{\theta}_{\pi/2} + 2\omega \end{array}$$

Free-space trebuchet kinematics by symmetry: Direct approach and Superball analogy

Case of equal arms $r = \ell$ (easier algebra)

$$\left. \begin{aligned} 2E &= MR^2 \dot{\theta}^2 + mr^2 (\dot{\theta}^2 + 2\dot{\phi}\dot{\theta} \sin \phi_B + \dot{\phi}^2) \\ \Lambda &= MR^2 \dot{\theta} + mr^2 (1 + \sin \phi_B) (\dot{\theta} + \dot{\phi}) \end{aligned} \right\} \text{For: } r = \ell$$

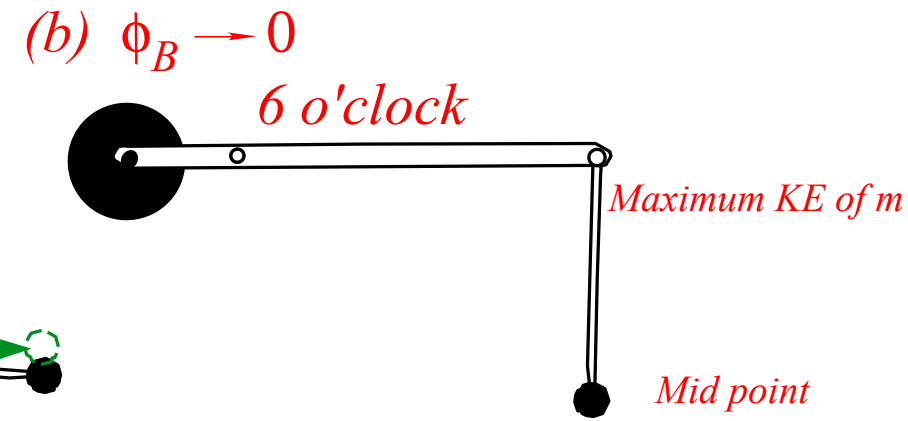
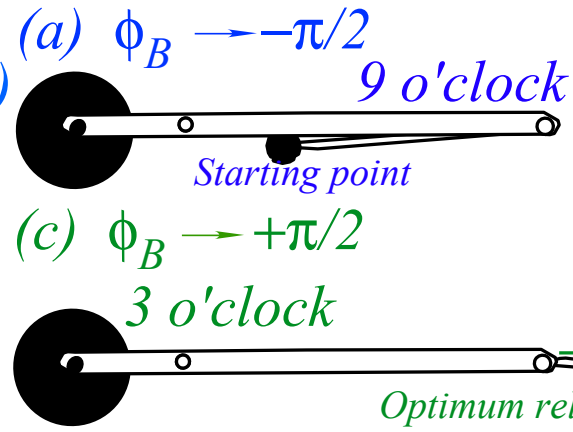

Start at 9 o'clock with $\phi_B \sim -90^\circ$ (beam r and throwing arm ℓ rotating together)

$$\left. \begin{aligned} \phi_B &= \frac{-\pi}{2} \\ \sin \phi_B &= -1 \end{aligned} \right\} \begin{cases} 2E = MR^2 \dot{\theta}_{-\pi/2}^2 + mr^2 (\dot{\phi}_{-\pi/2} - \dot{\theta}_{-\pi/2})^2 \\ \Lambda = MR^2 \dot{\theta}_{-\pi/2} \end{cases} \text{Conserved} \\ \text{or: } \begin{cases} \text{initial } 2E \\ 2E = MR^2 \omega^2 \\ \Lambda = MR^2 \omega \\ \text{initial } \Lambda \end{cases} \text{For: } \dot{\theta}_{-\pi/2} = \omega = \dot{\phi}_{-\pi/2}$$

Move to 6 o'clock with $\phi_B \sim 0^\circ$ (beam r slowing, throwing arm ℓ accelerating)

$$\left. \begin{aligned} \phi_B &= 0 \\ \sin \phi_B &= 0 \end{aligned} \right\} \begin{cases} 2E = MR^2 \dot{\theta}_0^2 + mr^2 (\dot{\phi}_0^2 + \dot{\theta}_0^2) \\ \Lambda = MR^2 \dot{\theta}_0 + mr^2 (\dot{\phi}_0 + \dot{\theta}_0) \end{cases}$$

$$KE(m) = \frac{mr^2}{2} (\dot{\phi}^2 + \dot{\theta}^2 + 2\dot{\phi}\dot{\theta} \sin \phi_B) = \begin{cases} \frac{mr^2}{2} (\dot{\phi} - \dot{\theta})^2 & \left(\text{For: } \phi_B = -\frac{\pi}{2} \right) \\ \frac{mr^2}{2} (\dot{\phi}^2 + \dot{\theta}^2) & \left(\text{For: } \phi_B = 0 \right) \\ \frac{mr^2}{2} (\dot{\phi} + \dot{\theta})^2 & \left(\text{For: } \phi_B = \frac{\pi}{2} \right) \end{cases}$$

Move to 3 o'clock with $\phi_B \sim +90^\circ$ (beam r slowed, throwing arm ℓ releasing)

$$\left. \begin{aligned} \phi_B &= \pi/2 \\ \sin \phi_B &= +1 \end{aligned} \right\} \begin{cases} 2E = MR^2 \dot{\theta}_{\pi/2}^2 + mr^2 (\dot{\phi}_{\pi/2} + \dot{\theta}_{\pi/2})^2 \\ \Lambda = MR^2 \dot{\theta}_{\pi/2} + 2mr^2 (\dot{\phi}_{\pi/2} + \dot{\theta}_{\pi/2}) \end{cases} \text{Conserved} \\ \begin{aligned} &= MR^2 \omega^2 \text{ (initial } 2E) \longrightarrow (\omega^2 - \dot{\theta}_{\pi/2}^2) = \frac{mr^2}{MR^2} (\dot{\phi}_{\pi/2} + \dot{\theta}_{\pi/2})^2 \\ &= MR^2 \omega \text{ (initial } \Lambda) \longrightarrow (\omega - \dot{\theta}_{\pi/2}) = \frac{2mr^2}{MR^2} (\dot{\phi}_{\pi/2} + \dot{\theta}_{\pi/2}) \end{aligned} \\ \begin{aligned} &\xrightarrow{\text{divide } 2E} (\omega^2 - \dot{\theta}_{\pi/2}^2) = \frac{mr^2}{MR^2} (\dot{\phi}_{\pi/2} + \dot{\theta}_{\pi/2})^2 \\ &\xrightarrow{\text{by } \Lambda} (\omega - \dot{\theta}_{\pi/2}) = \frac{2mr^2}{MR^2} (\dot{\phi}_{\pi/2} + \dot{\theta}_{\pi/2}) \\ &\xrightarrow{\text{substitute}} \omega - \dot{\theta}_{\pi/2} = \frac{2mr^2}{MR^2} (2\omega + 2\dot{\theta}_{\pi/2}) \end{aligned} \\ \text{Result: } \dot{\phi}_{\pi/2} = \dot{\theta}_{\pi/2} + 2\omega \end{aligned}$$

Free-space trebuchet kinematics by symmetry: Direct approach and Superball analogy

Case of equal arms $r = \ell$ (easier algebra)

$$\left. \begin{aligned} 2E &= MR^2 \dot{\theta}^2 + mr^2 (\dot{\theta}^2 + 2\dot{\phi}\dot{\theta} \sin \phi_B + \dot{\phi}^2) \\ \Lambda &= MR^2 \dot{\theta} + mr^2 (1 + \sin \phi_B) (\dot{\theta} + \dot{\phi}) \end{aligned} \right\} \text{For: } r = \ell$$

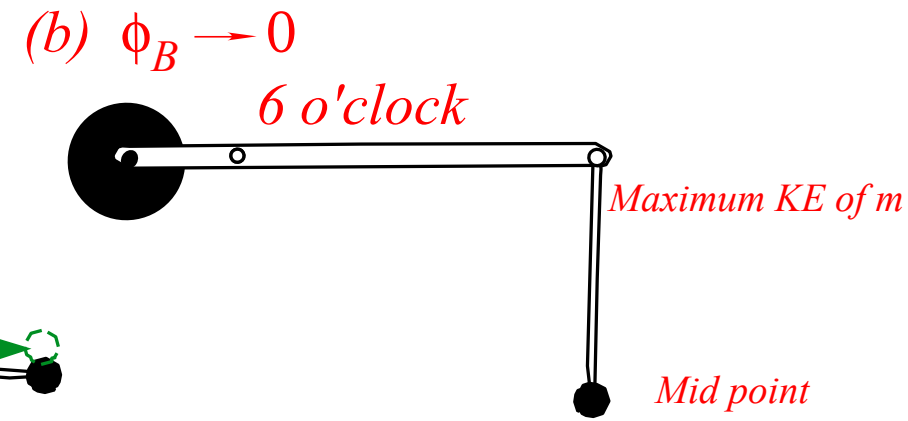
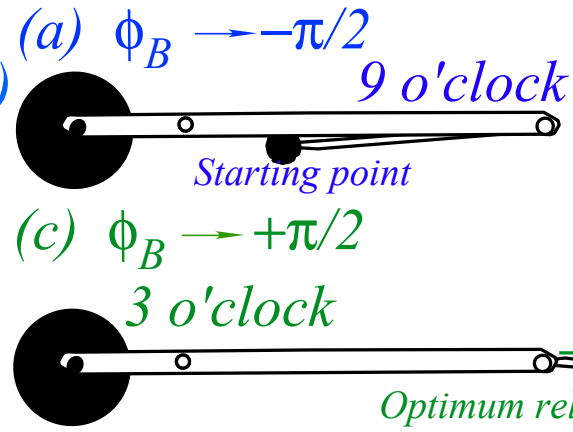

Start at 9 o'clock with $\phi_B \sim -90^\circ$ (beam r and throwing arm ℓ rotating together)

$$\left. \begin{aligned} \phi_B &= \frac{-\pi}{2} \\ \sin \phi_B &= -1 \end{aligned} \right\} \begin{cases} 2E = MR^2 \dot{\theta}_{-\pi/2}^2 + mr^2 (\dot{\phi}_{-\pi/2} - \dot{\theta}_{-\pi/2})^2 \\ \Lambda = MR^2 \dot{\theta}_{-\pi/2} \end{cases} \text{Conserved}$$

initial $2E$
initial Λ

$$\text{or: } \begin{cases} 2E = MR^2 \omega^2 \\ \Lambda = MR^2 \omega \end{cases} \text{For: } \dot{\theta}_{-\pi/2} = \omega = \dot{\phi}_{-\pi/2}$$

Move to 6 o'clock with $\phi_B \sim 0^\circ$ (beam r slowing, throwing arm ℓ accelerating)

$$\left. \begin{aligned} \phi_B &= 0 \\ \sin \phi_B &= 0 \end{aligned} \right\} \begin{cases} 2E = MR^2 \dot{\theta}_0^2 + mr^2 (\dot{\phi}_0^2 + \dot{\theta}_0^2) \\ \Lambda = MR^2 \dot{\theta}_0 + mr^2 (\dot{\phi}_0 + \dot{\theta}_0) \end{cases}$$

$$KE(m) = \frac{mr^2}{2} (\dot{\phi}^2 + \dot{\theta}^2 + 2\dot{\phi}\dot{\theta} \sin \phi_B)$$

$$= \begin{cases} \frac{mr^2}{2} (\dot{\phi} - \dot{\theta})^2 & \left(\text{For: } \phi_B = -\frac{\pi}{2} \right) \\ \frac{mr^2}{2} (\dot{\phi}^2 + \dot{\theta}^2) & \left(\text{For: } \phi_B = 0 \right) \\ \frac{mr^2}{2} (\dot{\phi} + \dot{\theta})^2 & \left(\text{For: } \phi_B = \frac{\pi}{2} \right) \end{cases}$$

Move to 3 o'clock with $\phi_B \sim +90^\circ$ (beam r slowed, throwing arm ℓ releasing)

$$\left. \begin{aligned} \phi_B &= \pi/2 \\ \sin \phi_B &= +1 \end{aligned} \right\} \begin{cases} 2E = MR^2 \dot{\theta}_{\pi/2}^2 + mr^2 (\dot{\phi}_{\pi/2} + \dot{\theta}_{\pi/2})^2 \\ \Lambda = MR^2 \dot{\theta}_{\pi/2} + 2mr^2 (\dot{\phi}_{\pi/2} + \dot{\theta}_{\pi/2}) \end{cases} \text{Conserved}$$

initial $2E$
initial Λ

$$\begin{aligned} (\omega^2 - \dot{\theta}_{\pi/2}^2) &= \frac{mr^2}{MR^2} (\dot{\phi}_{\pi/2} + \dot{\theta}_{\pi/2})^2 && \xrightarrow{\text{divide } 2E} \\ (\omega - \dot{\theta}_{\pi/2}) &= \frac{2mr^2}{MR^2} (\dot{\phi}_{\pi/2} + \dot{\theta}_{\pi/2}) && \xrightarrow{\text{by } \Lambda} \\ \omega - \dot{\theta}_{\pi/2} &= \frac{2mr^2}{MR^2} (2\omega + 2\dot{\theta}_{\pi/2}) && \xrightarrow{\text{substitute}} \\ \omega - \frac{4mr^2}{MR^2} \omega &= \dot{\theta}_{\pi/2} + \frac{4mr^2}{MR^2} \dot{\theta}_{\pi/2} && \end{aligned}$$

$$(\omega + \dot{\theta}_{\pi/2}) = \frac{1}{2} (\dot{\phi}_{\pi/2} + \dot{\theta}_{\pi/2})$$

$$\dot{\phi}_{\pi/2} = \dot{\theta}_{\pi/2} + 2\omega$$

Free-space trebuchet kinematics by symmetry: Direct approach and Superball analogy

Case of equal arms $r = \ell$ (easier algebra)

$$\left. \begin{aligned} 2E &= MR^2 \dot{\theta}^2 + mr^2 (\dot{\theta}^2 + 2\dot{\phi}\dot{\theta} \sin \phi_B + \dot{\phi}^2) \\ \Lambda &= MR^2 \dot{\theta} + mr^2 (1 + \sin \phi_B) (\dot{\theta} + \dot{\phi}) \end{aligned} \right\} \text{For: } r = \ell$$

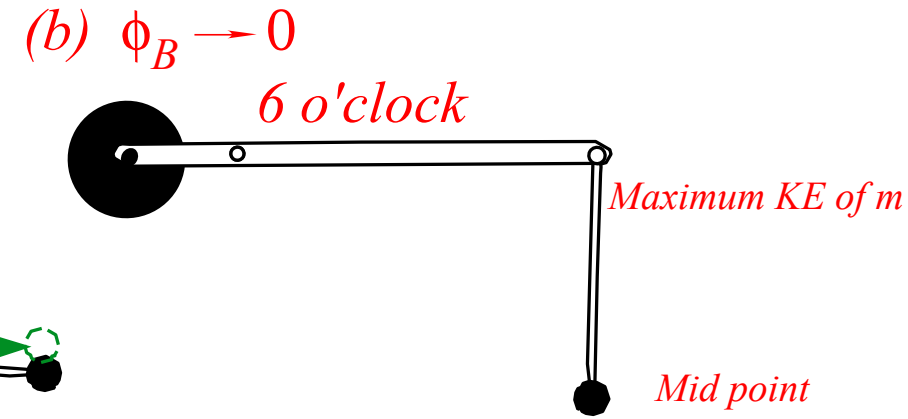
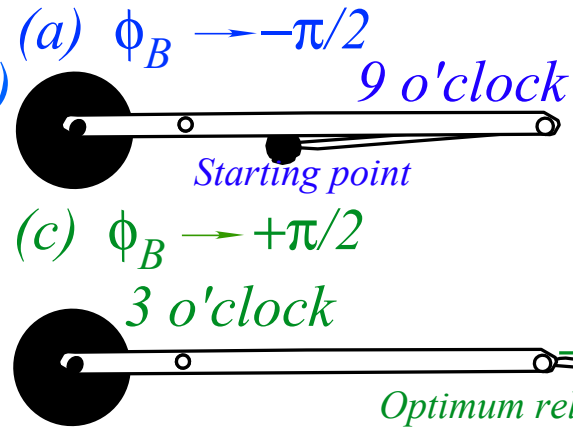

Start at 9 o'clock with $\phi_B \sim -90^\circ$ (beam r and throwing arm ℓ rotating together)

$$\phi_B = \frac{-\pi}{2}, \sin \phi_B = -1 \left\{ \begin{aligned} 2E &= MR^2 \dot{\theta}_{-\pi/2}^2 + mr^2 (\dot{\phi}_{-\pi/2} - \dot{\theta}_{-\pi/2})^2 \\ \Lambda &= MR^2 \dot{\theta}_{-\pi/2} \end{aligned} \right. \text{Conserved initial } 2E \text{ or } \left\{ \begin{aligned} 2E &= MR^2 \omega^2 \\ \Lambda &= MR^2 \omega \end{aligned} \right. \text{For: } \dot{\theta}_{-\pi/2} = \omega = \dot{\phi}_{-\pi/2}$$

Move to 6 o'clock with $\phi_B \sim 0^\circ$ (beam r slowing, throwing arm ℓ accelerating)

$$\phi_B = 0, \sin \phi_B = 0 \left\{ \begin{aligned} 2E &= MR^2 \dot{\theta}_0^2 + mr^2 (\dot{\phi}_0^2 + \dot{\theta}_0^2) \\ \Lambda &= MR^2 \dot{\theta}_0 + mr^2 (\dot{\phi}_0 + \dot{\theta}_0) \end{aligned} \right.$$

$$KE(m) = \frac{mr^2}{2} (\dot{\phi}^2 + \dot{\theta}^2 + 2\dot{\phi}\dot{\theta} \sin \phi_B) = \begin{cases} \frac{mr^2}{2} (\dot{\phi} - \dot{\theta})^2 & \text{(For: } \phi_B = -\frac{\pi}{2}) \\ \frac{mr^2}{2} (\dot{\phi}^2 + \dot{\theta}^2) & \text{(For: } \phi_B = 0) \\ \frac{mr^2}{2} (\dot{\phi} + \dot{\theta})^2 & \text{(For: } \phi_B = \frac{\pi}{2}) \end{cases}$$

Move to 3 o'clock with $\phi_B \sim +90^\circ$ (beam r slowed, throwing arm ℓ releasing)

$$\phi_B = \pi/2, \sin \phi_B = +1 \left\{ \begin{aligned} 2E &= MR^2 \dot{\theta}_{\pi/2}^2 + mr^2 (\dot{\phi}_{\pi/2} + \dot{\theta}_{\pi/2})^2 = MR^2 \omega^2 \text{ (Conserved initial } 2E) \\ \Lambda &= MR^2 \dot{\theta}_{\pi/2} + 2mr^2 (\dot{\phi}_{\pi/2} + \dot{\theta}_{\pi/2}) = MR^2 \omega \text{ (Conserved initial } \Lambda) \end{aligned} \right.$$

$$\begin{aligned} (\omega^2 - \dot{\theta}_{\pi/2}^2) &= \frac{mr^2}{MR^2} (\dot{\phi}_{\pi/2} + \dot{\theta}_{\pi/2})^2 \xrightarrow{\text{divide } 2E} (\omega + \dot{\theta}_{\pi/2}) = \frac{1}{2} (\dot{\phi}_{\pi/2} + \dot{\theta}_{\pi/2}) \\ (\omega - \dot{\theta}_{\pi/2}) &= \frac{2mr^2}{MR^2} (\dot{\phi}_{\pi/2} + \dot{\theta}_{\pi/2}) \xrightarrow{\text{by } \Lambda} (\omega - \dot{\theta}_{\pi/2}) = \frac{2mr^2}{MR^2} (2\omega + 2\dot{\theta}_{\pi/2}) \\ \omega - \frac{4mr^2}{MR^2} \omega &= \dot{\theta}_{\pi/2} + \frac{4mr^2}{MR^2} \dot{\theta}_{\pi/2} \xrightarrow{\text{solve}} \dot{\theta}_{\pi/2} = \frac{1 - \frac{4mr^2}{MR^2}}{1 + \frac{4mr^2}{MR^2}} \omega \end{aligned}$$

$$\dot{\phi}_{\pi/2} = \dot{\theta}_{\pi/2} + 2\omega$$

Free-space trebuchet kinematics by symmetry: Direct approach and Superball analogy

Case of equal arms $r = \ell$ (easier algebra)

$$\left. \begin{aligned} 2E &= MR^2 \dot{\theta}^2 + mr^2 (\dot{\theta}^2 + 2\dot{\phi}\dot{\theta} \sin \phi_B + \dot{\phi}^2) \\ \Lambda &= MR^2 \dot{\theta} + mr^2 (1 + \sin \phi_B) (\dot{\theta} + \dot{\phi}) \end{aligned} \right\} \text{For: } r = \ell$$

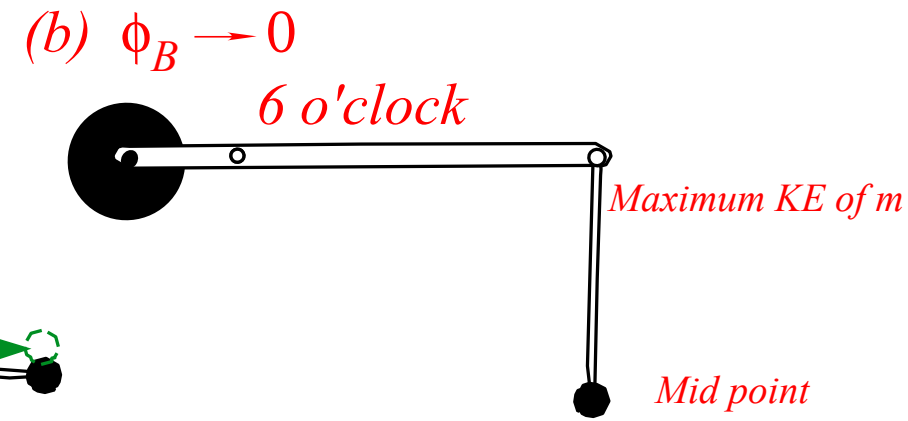
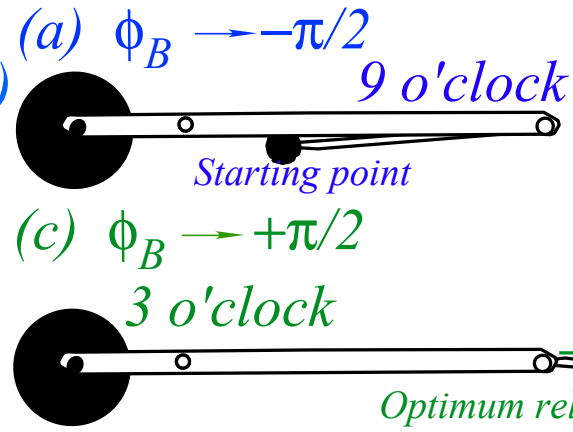

Start at 9 o'clock with $\phi_B \sim -90^\circ$ (beam r and throwing arm ℓ rotating together)

$$\left. \begin{aligned} \phi_B &= \frac{-\pi}{2} \\ \sin \phi_B &= -1 \end{aligned} \right\} \begin{aligned} 2E &= MR^2 \dot{\theta}_{-\pi/2}^2 + mr^2 (\dot{\phi}_{-\pi/2} - \dot{\theta}_{-\pi/2})^2 \\ \Lambda &= MR^2 \dot{\theta}_{-\pi/2} \end{aligned} \quad \text{Conserved} \quad \text{or: } \begin{cases} \text{initial } 2E \\ 2E = MR^2 \omega^2 \\ \Lambda = MR^2 \omega \\ \text{initial } \Lambda \end{cases} \quad \text{For: } \dot{\theta}_{-\pi/2} = \omega = \dot{\phi}_{-\pi/2}$$

Move to 6 o'clock with $\phi_B \sim 0^\circ$ (beam r slowing, throwing arm ℓ accelerating)

$$\left. \begin{aligned} \phi_B &= 0 \\ \sin \phi_B &= 0 \end{aligned} \right\} \begin{aligned} 2E &= MR^2 \dot{\theta}_0^2 + mr^2 (\dot{\phi}_0^2 + \dot{\theta}_0^2) \\ \Lambda &= MR^2 \dot{\theta}_0 + mr^2 (\dot{\phi}_0 + \dot{\theta}_0) \end{aligned}$$

$$KE(m) = \frac{mr^2}{2} (\dot{\phi}^2 + \dot{\theta}^2 + 2\dot{\phi}\dot{\theta} \sin \phi_B) = \begin{cases} \frac{mr^2}{2} (\dot{\phi} - \dot{\theta})^2 & \left(\text{For: } \phi_B = -\frac{\pi}{2} \right) \\ \frac{mr^2}{2} (\dot{\phi}^2 + \dot{\theta}^2) & \left(\text{For: } \phi_B = 0 \right) \\ \frac{mr^2}{2} (\dot{\phi} + \dot{\theta})^2 & \left(\text{For: } \phi_B = \frac{\pi}{2} \right) \end{cases}$$

Move to 3 o'clock with $\phi_B \sim +90^\circ$ (beam r slowed, throwing arm ℓ releasing)

$$\left. \begin{aligned} \phi_B &= \pi/2 \\ \sin \phi_B &= +1 \end{aligned} \right\} \begin{aligned} 2E &= MR^2 \dot{\theta}_{\pi/2}^2 + mr^2 (\dot{\phi}_{\pi/2} + \dot{\theta}_{\pi/2})^2 \\ \Lambda &= MR^2 \dot{\theta}_{\pi/2} + 2mr^2 (\dot{\phi}_{\pi/2} + \dot{\theta}_{\pi/2}) \end{aligned} \quad \begin{aligned} &\text{Conserved} \\ &\text{initial } 2E \\ &= MR^2 \omega^2 \end{aligned}$$

$$\begin{aligned} (\omega^2 - \dot{\theta}_{\pi/2}^2) &= \frac{mr^2}{MR^2} (\dot{\phi}_{\pi/2} + \dot{\theta}_{\pi/2})^2 && \text{divide } 2E \\ (\omega - \dot{\theta}_{\pi/2}) &= \frac{2mr^2}{MR^2} (\dot{\phi}_{\pi/2} + \dot{\theta}_{\pi/2}) && \text{by } \Lambda \\ \omega - \dot{\theta}_{\pi/2} &= \frac{2mr^2}{MR^2} (2\omega + 2\dot{\theta}_{\pi/2}) && \text{substitute } \dot{\phi}_{\pi/2} = \dot{\theta}_{\pi/2} + 2\omega \\ \omega - \frac{4mr^2}{MR^2} \omega &= \dot{\theta}_{\pi/2} + \frac{4mr^2}{MR^2} \dot{\theta}_{\pi/2} && \text{solve} \\ \dot{\theta}_{\pi/2} &= \frac{1 - \frac{4mr^2}{MR^2}}{1 + \frac{4mr^2}{MR^2}} \omega \end{aligned}$$

Large $M \gg m$ case

$$\dot{\phi}_{\pi/2} = \omega + 2\omega = 3\omega$$

$$\dot{\theta}_{\pi/2} = \frac{1-0}{1+0} \omega = \omega$$

Free-space trebuchet kinematics by symmetry: Direct approach and Superball analogy

Case of equal arms $r = \ell$ (easier algebra)

$$\left. \begin{aligned} 2E &= MR^2 \dot{\theta}^2 + mr^2 (\dot{\theta}^2 + 2\dot{\phi}\dot{\theta} \sin \phi_B + \dot{\phi}^2) \\ \Lambda &= MR^2 \dot{\theta} + mr^2 (1 + \sin \phi_B) (\dot{\theta} + \dot{\phi}) \end{aligned} \right\} \text{For: } r = \ell$$

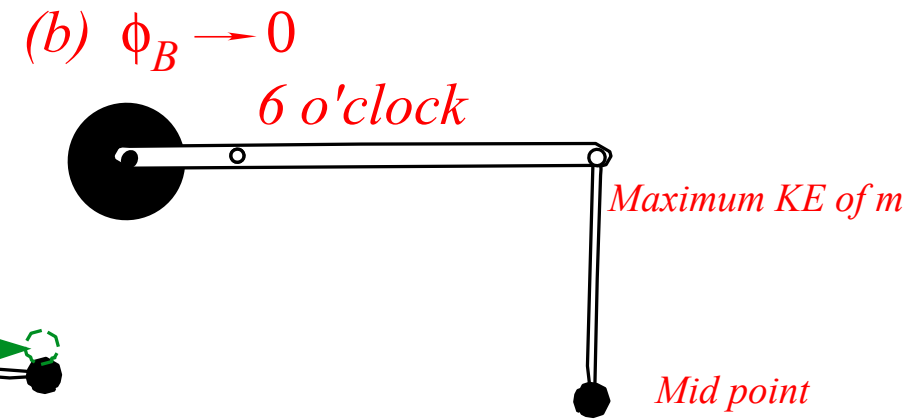
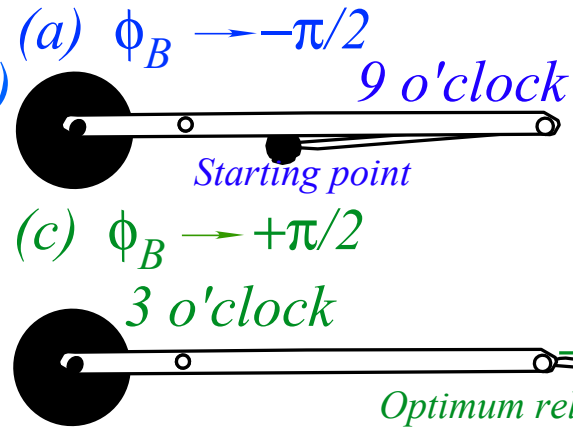

Start at 9 o'clock with $\phi_B \sim -90^\circ$ (beam r and throwing arm ℓ rotating together)

$$\left. \begin{aligned} \phi_B &= \frac{-\pi}{2} \\ \sin \phi_B &= -1 \end{aligned} \right\} \begin{cases} 2E = MR^2 \dot{\theta}_{-\pi/2}^2 + mr^2 (\dot{\phi}_{-\pi/2} - \dot{\theta}_{-\pi/2})^2 \\ \Lambda = MR^2 \dot{\theta}_{-\pi/2} \end{cases} \text{Conserved} \quad \text{or: } \begin{cases} \text{initial } 2E \\ 2E = MR^2 \omega^2 \\ \Lambda = MR^2 \omega \\ \text{initial } \Lambda \end{cases} \quad \text{For: } \dot{\theta}_{-\pi/2} = \omega = \dot{\phi}_{-\pi/2}$$

Move to 6 o'clock with $\phi_B \sim 0^\circ$ (beam r slowing, throwing arm ℓ accelerating)

$$\left. \begin{aligned} \phi_B &= 0 \\ \sin \phi_B &= 0 \end{aligned} \right\} \begin{cases} 2E = MR^2 \dot{\theta}_0^2 + mr^2 (\dot{\phi}_0^2 + \dot{\theta}_0^2) \\ \Lambda = MR^2 \dot{\theta}_0 + mr^2 (\dot{\phi}_0 + \dot{\theta}_0) \end{cases}$$

$$KE(m) = \frac{mr^2}{2} (\dot{\phi}^2 + \dot{\theta}^2 + 2\dot{\phi}\dot{\theta} \sin \phi_B) = \begin{cases} \frac{mr^2}{2} (\dot{\phi} - \dot{\theta})^2 & \left(\text{For: } \phi_B = -\frac{\pi}{2} \right) \\ \frac{mr^2}{2} (\dot{\phi}^2 + \dot{\theta}^2) & \left(\text{For: } \phi_B = 0 \right) \\ \frac{mr^2}{2} (\dot{\phi} + \dot{\theta})^2 & \left(\text{For: } \phi_B = \frac{\pi}{2} \right) \end{cases}$$

Move to 3 o'clock with $\phi_B \sim +90^\circ$ (beam r slowed, throwing arm ℓ releasing)

$$\left. \begin{aligned} \phi_B &= \pi/2 \\ \sin \phi_B &= +1 \end{aligned} \right\} \begin{cases} 2E = MR^2 \dot{\theta}_{\pi/2}^2 + mr^2 (\dot{\phi}_{\pi/2} + \dot{\theta}_{\pi/2})^2 \\ \Lambda = MR^2 \dot{\theta}_{\pi/2} + 2mr^2 (\dot{\phi}_{\pi/2} + \dot{\theta}_{\pi/2}) \end{cases} \text{Conserved} \quad \begin{aligned} &\text{initial } 2E \\ &= MR^2 \omega^2 \end{aligned} \rightarrow (\omega^2 - \dot{\theta}_{\pi/2}^2) = \frac{mr^2}{MR^2} (\dot{\phi}_{\pi/2} + \dot{\theta}_{\pi/2})^2$$

Large $M \gg m$ case

$$\dot{\phi}_{\pi/2} = \omega + 2\omega = 3\omega$$

$$\dot{\theta}_{\pi/2} = \frac{1-0}{1+0} \omega = \omega$$

Optimum $MR^2 = 4mr^2$ case

$$\dot{\phi}_{\pi/2} = 0 + 2\omega = 2\omega$$

$$\dot{\theta}_{\pi/2} = \frac{1-1}{1+1} \omega = 0$$

$$\begin{aligned} &\xrightarrow{\text{divide } 2E} (\omega^2 - \dot{\theta}_{\pi/2}^2) = \frac{mr^2}{MR^2} (\dot{\phi}_{\pi/2} + \dot{\theta}_{\pi/2})^2 \\ &\xrightarrow{\text{by } \Lambda} (\omega - \dot{\theta}_{\pi/2}) = \frac{2mr^2}{MR^2} (\dot{\phi}_{\pi/2} + \dot{\theta}_{\pi/2}) \\ &\xrightarrow{\text{substitute}} \omega - \dot{\theta}_{\pi/2} = \frac{2mr^2}{MR^2} (2\omega + 2\dot{\theta}_{\pi/2}) \\ &\xrightarrow{\text{solve}} \omega - \frac{4mr^2}{MR^2} \omega = \dot{\theta}_{\pi/2} + \frac{4mr^2}{MR^2} \dot{\theta}_{\pi/2} \end{aligned} \rightarrow \dot{\theta}_{\pi/2} = \frac{1 - \frac{4mr^2}{MR^2}}{1 + \frac{4mr^2}{MR^2}} \omega$$

Super-elastic Bounce

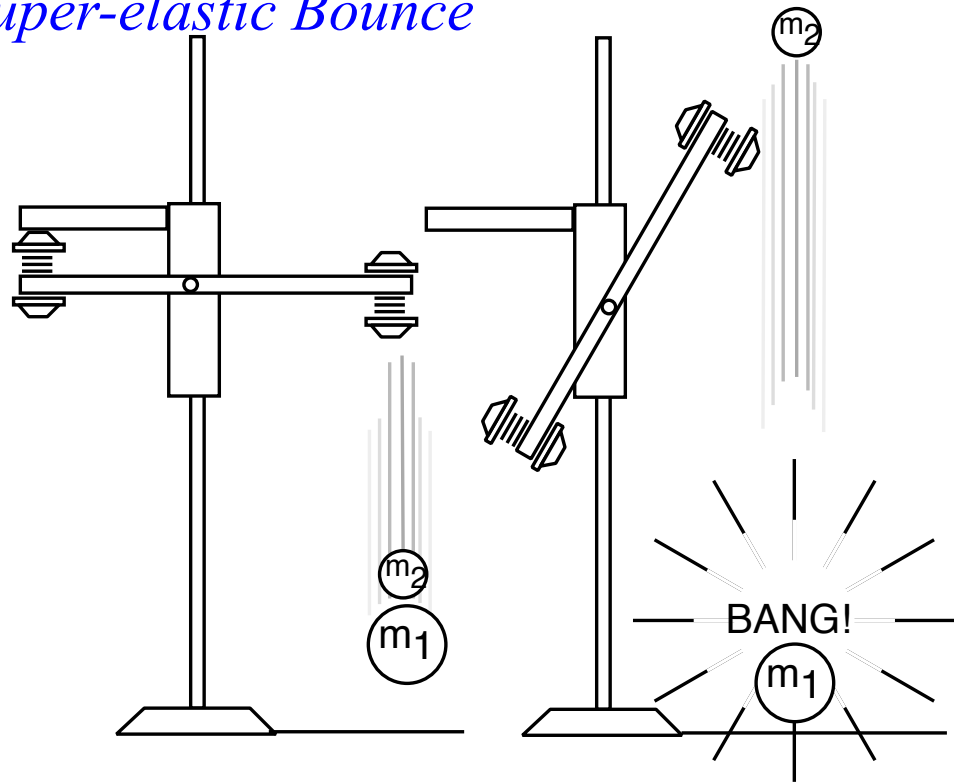

Analogous Superball Models

Similar in some ways to trebuchet models

Class of W. G. Harter, "Velocity Amplification in Collision Experiments Involving Superballs," *Am. J. Phys.* 39, 656 (1971) (A class project)

2-Bang Model

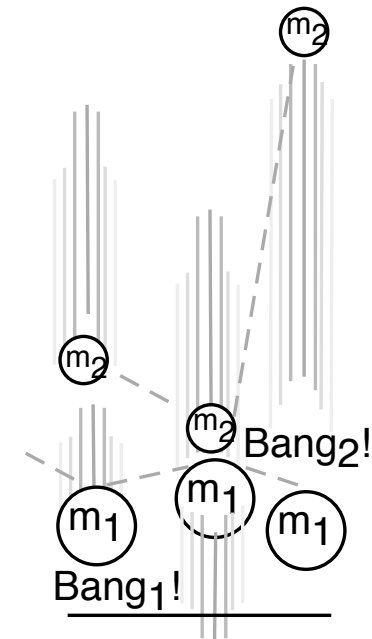

Space Plot (x versus y)

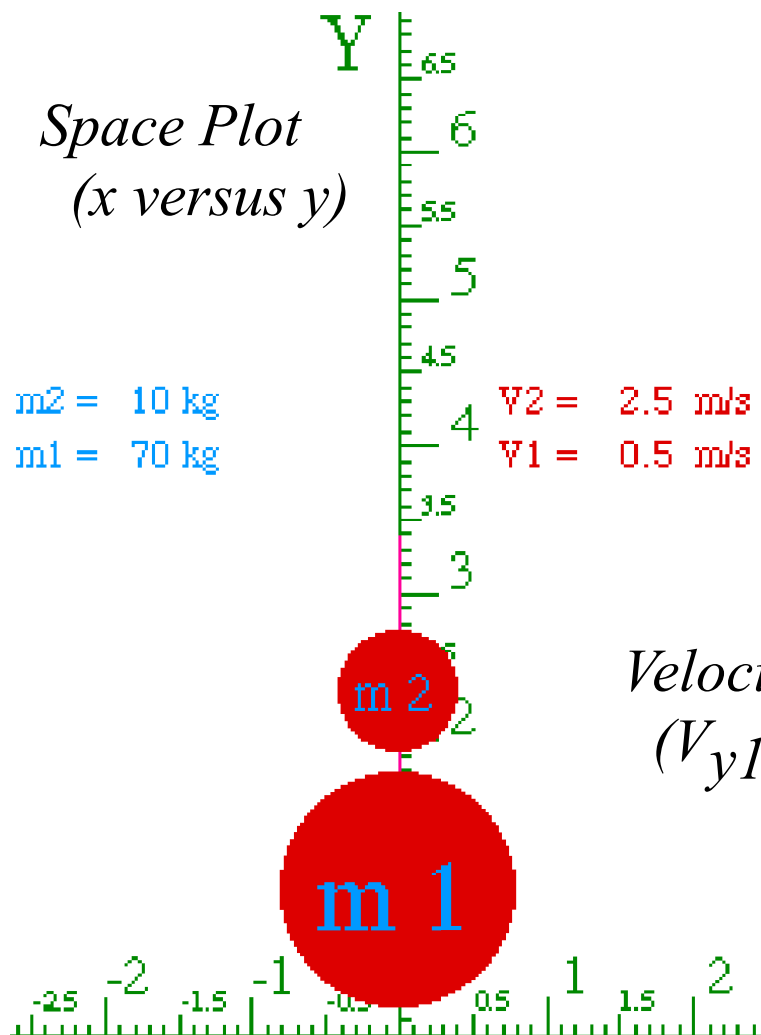

Velocity Plot (Vy1 versus Vy2)

Optimal Throw
 $m_1:m_2 = 3:1$
 100% Energy Transfer
 FINAL V is 2 times INITIAL V

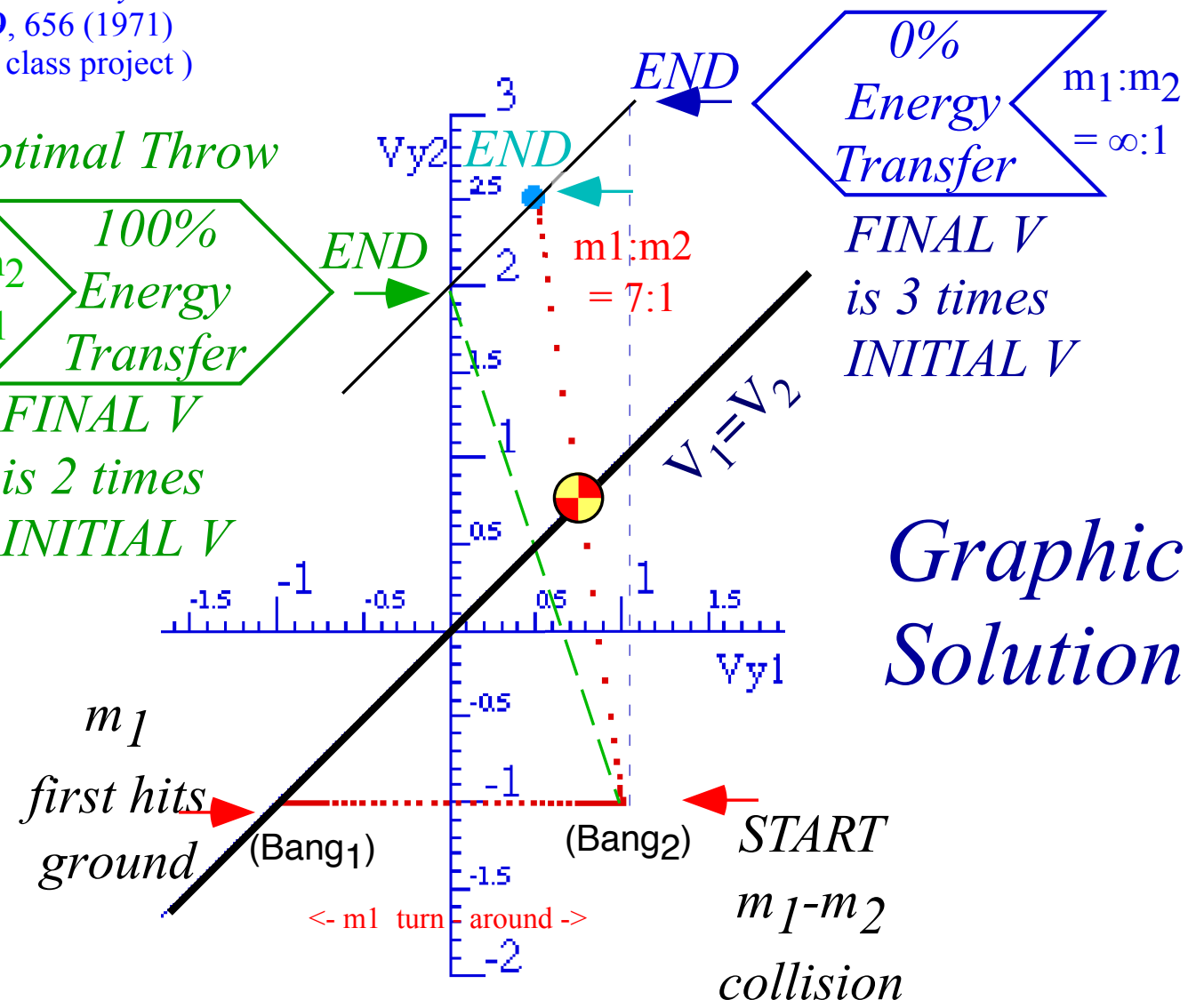

Graphic Solution

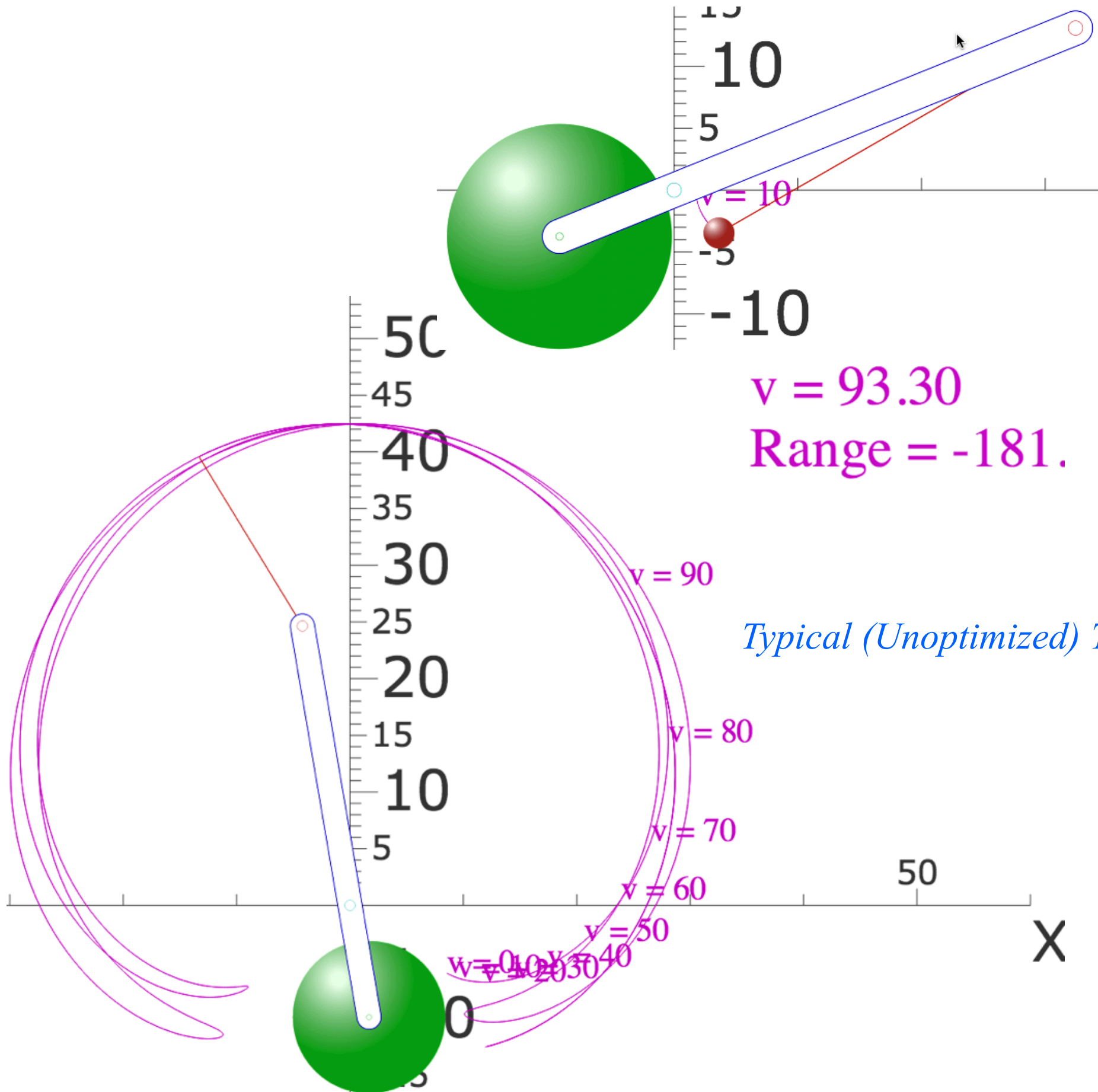

Typical (Unoptimized) Trebuchet

*Trebuchet in Siege of Kenilworth 1215 ACE
(Re-enactment shown on NOVA-TV 2005)*

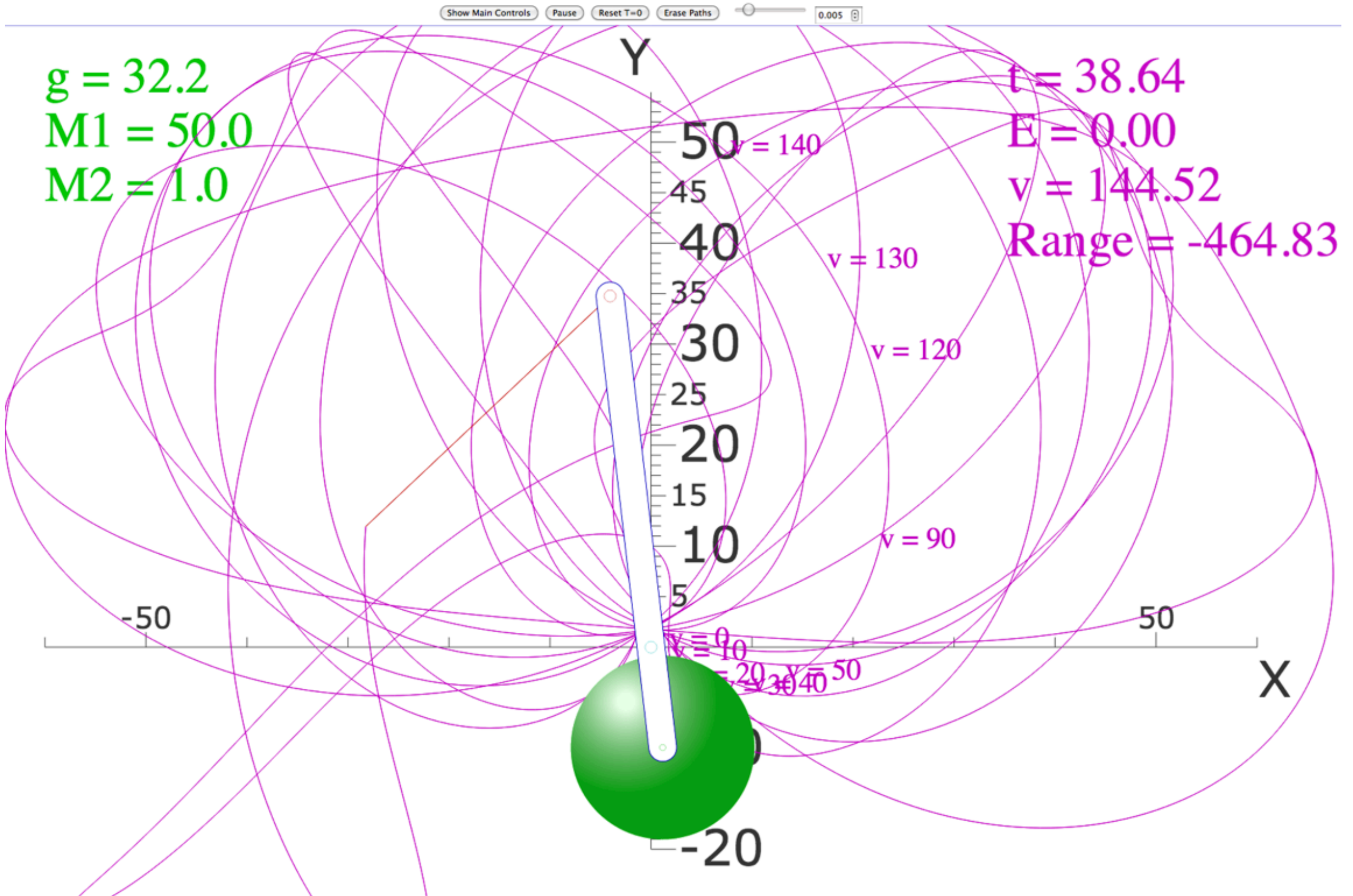

There is a claim that Cortez built a trebuchet to lay siege on Montezuma around 1500...

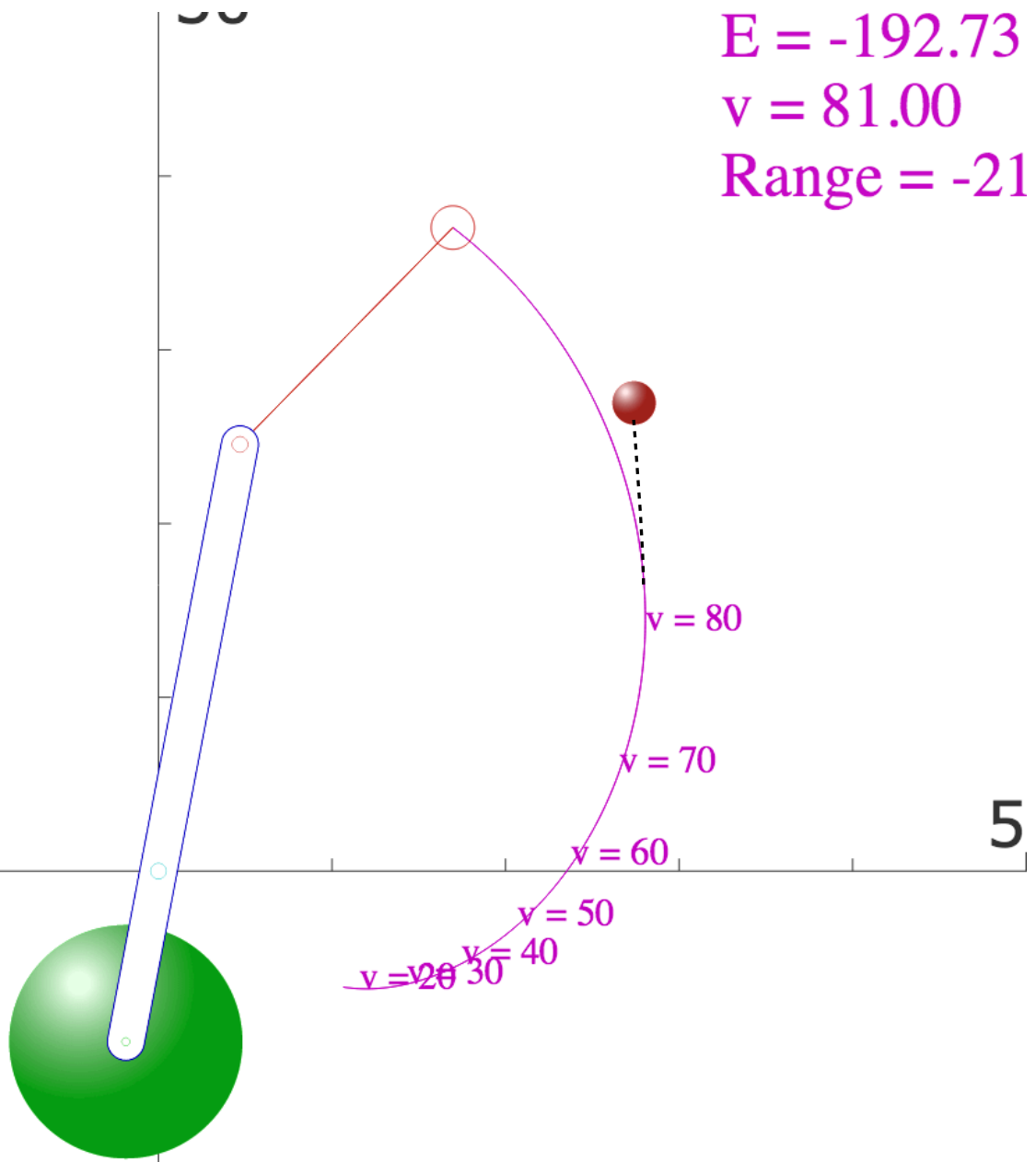

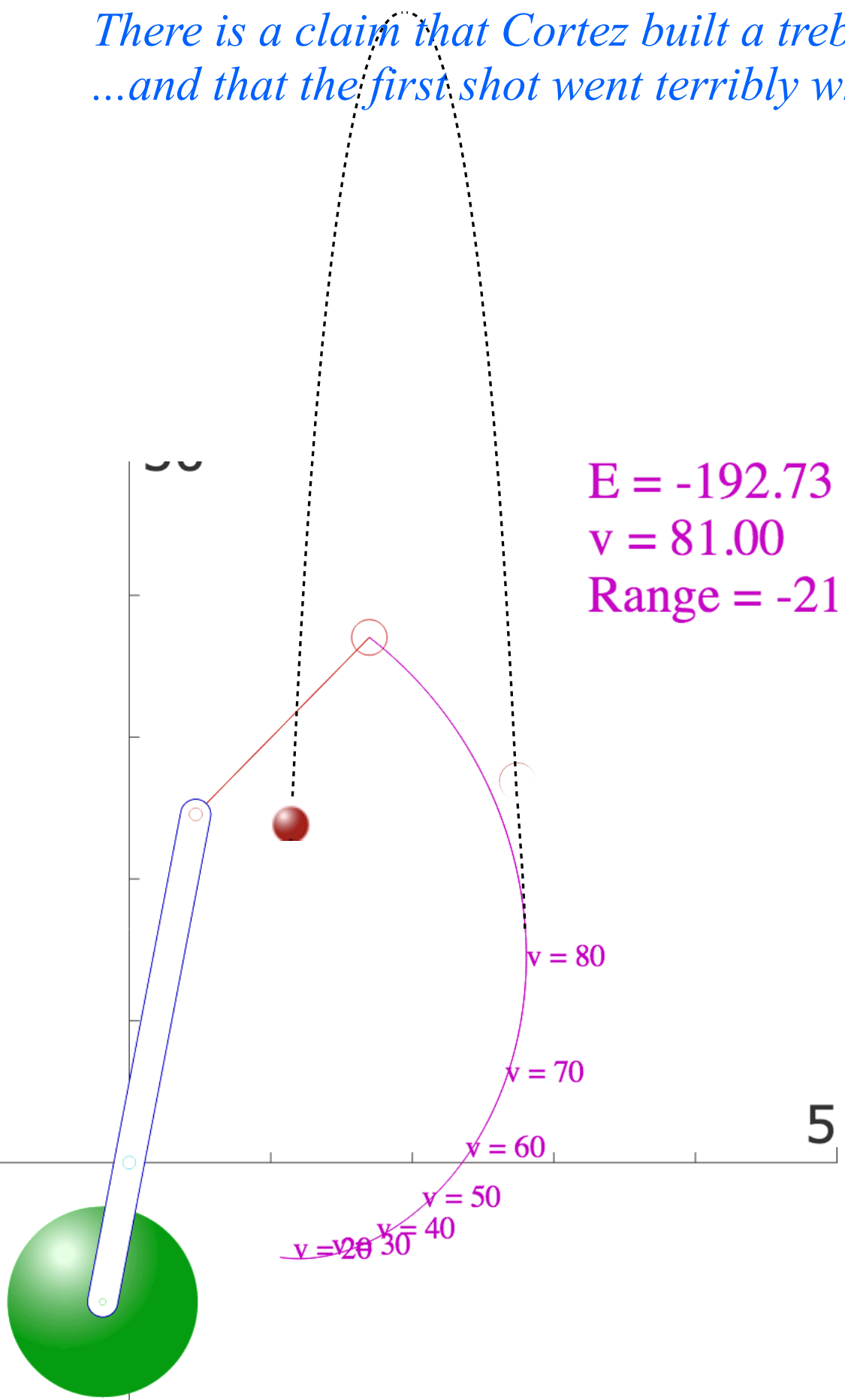

*There is a claim that Cortez built a trebuchet to lay siege on Montezuma around 1500...
...and that the first shot went terribly wrong...*

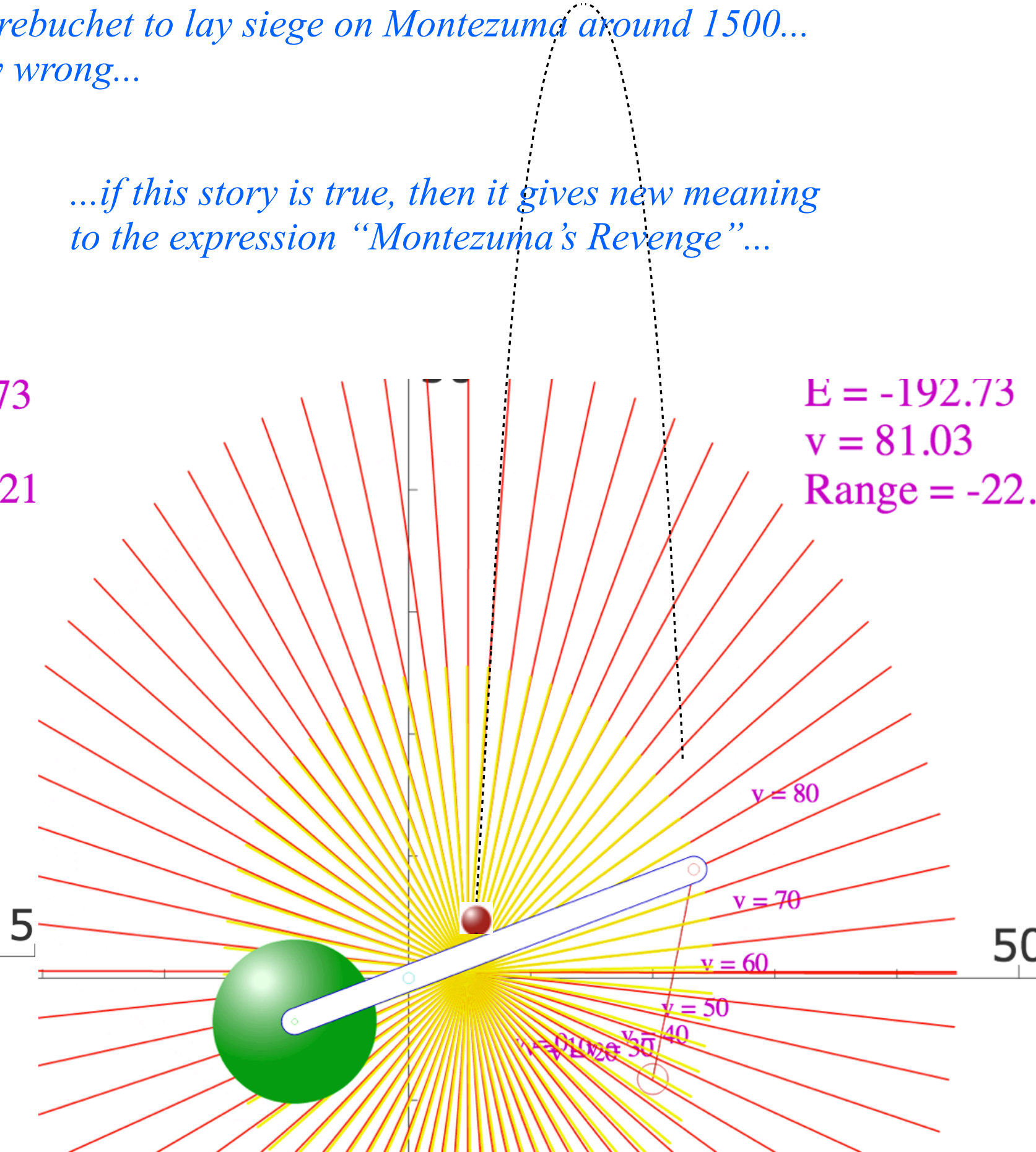
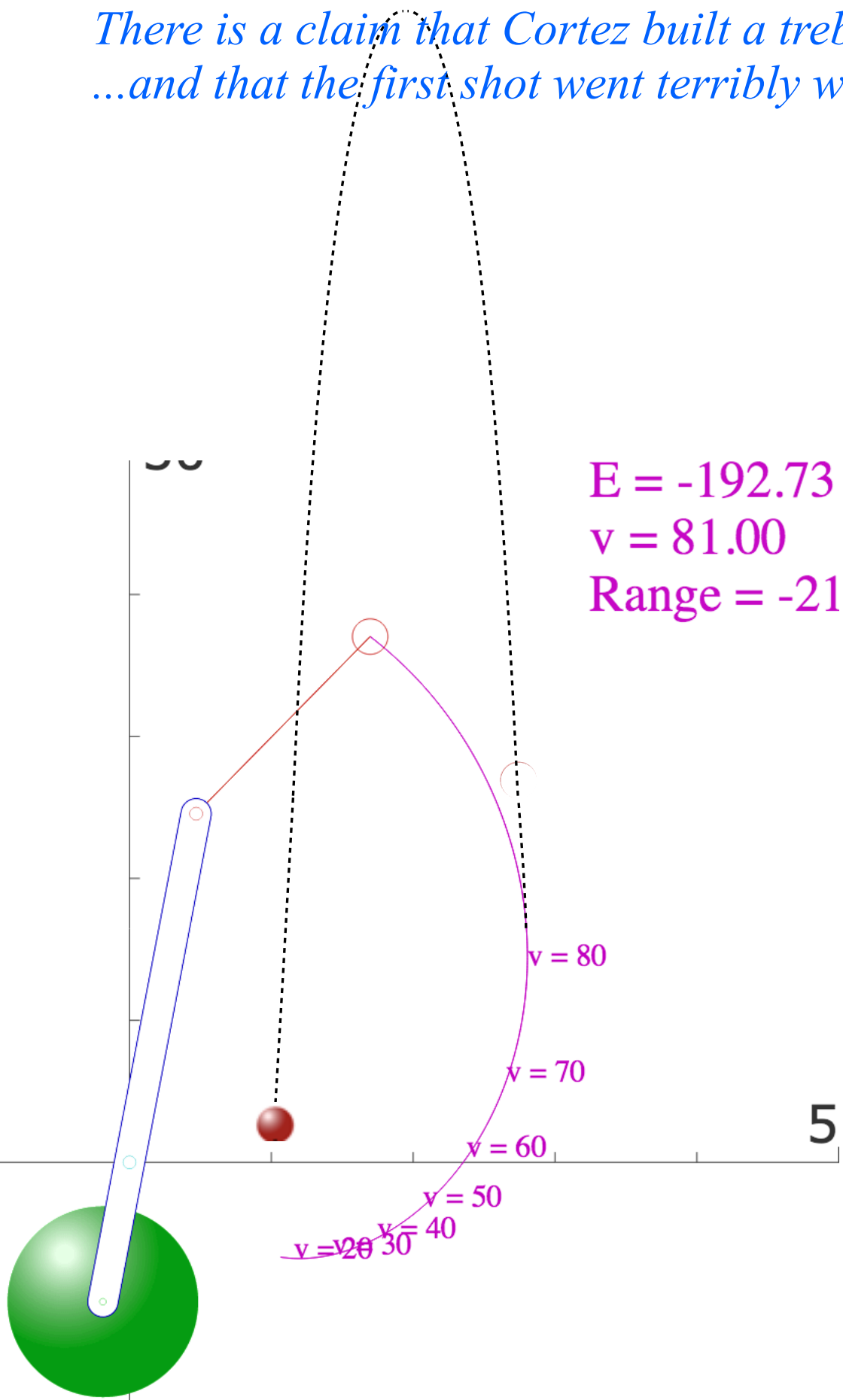

*There is a claim that Cortez built a trebuchet to lay siege on Montezuma around 1500...
...and that the first shot went terribly wrong...*

*...if this story is true, then it gives new meaning
to the expression "Montezuma's Revenge"...*



Hamiltonian energy and momentum conservation and symmetry coordinates
Coordinate transformation helps reduce symmetric Hamiltonian
Free-space trebuchet kinematics by symmetry
Algebraic approach
Direct approach and Superball analogy
 *Trebuchet vs Flinger and sports kinematics*
Many approaches to Mechanics

Early Human Agriculture and Infrastructure Building Activity

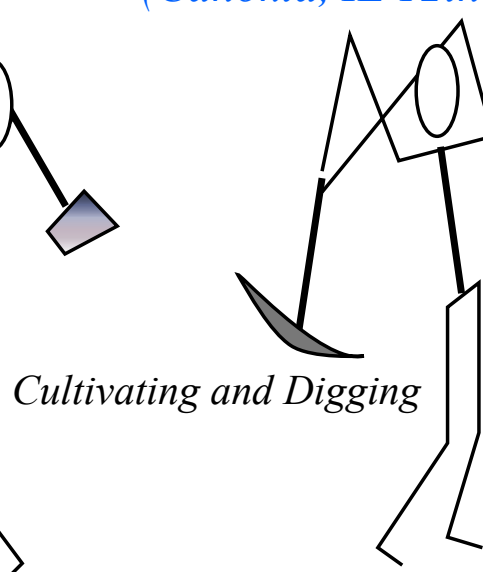
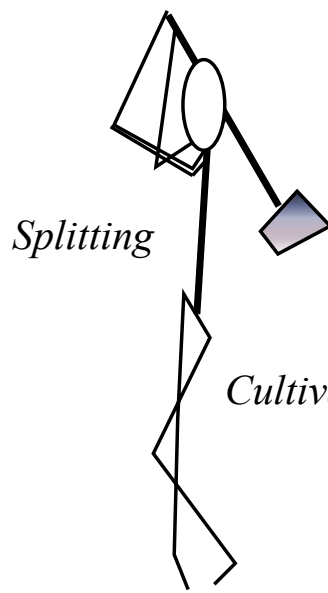
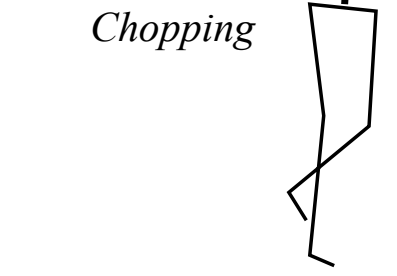
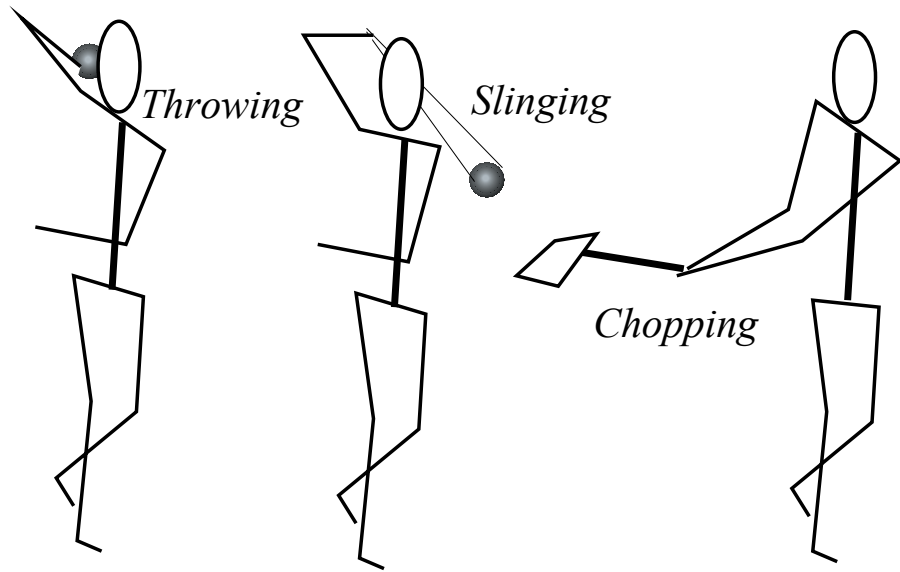

The Atlatl (Cahokia, IL 12th Century)

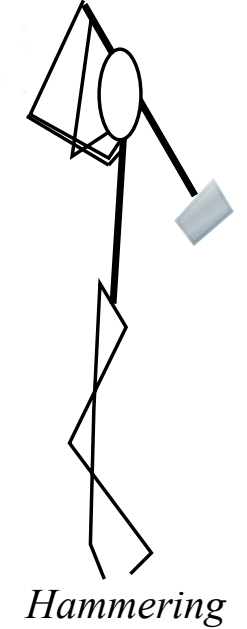
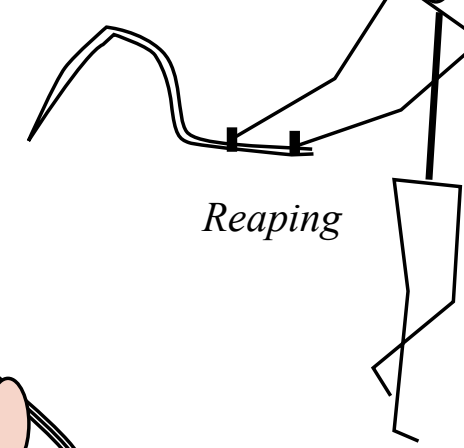
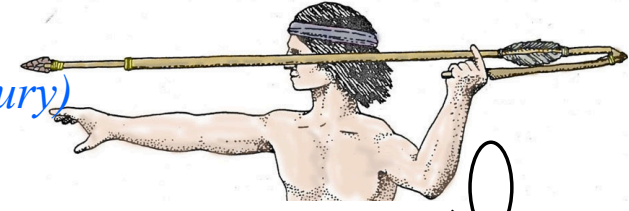

What Trebuchet mechanics is really good for...

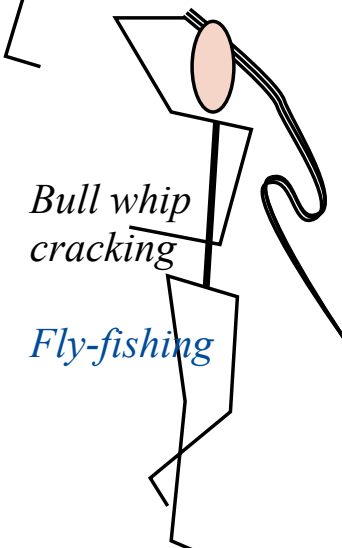

“Ring-The-Bell” (at the Fair)

Later Human Recreational Activity

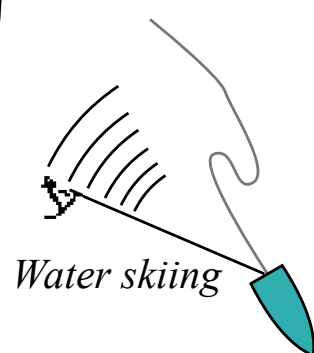
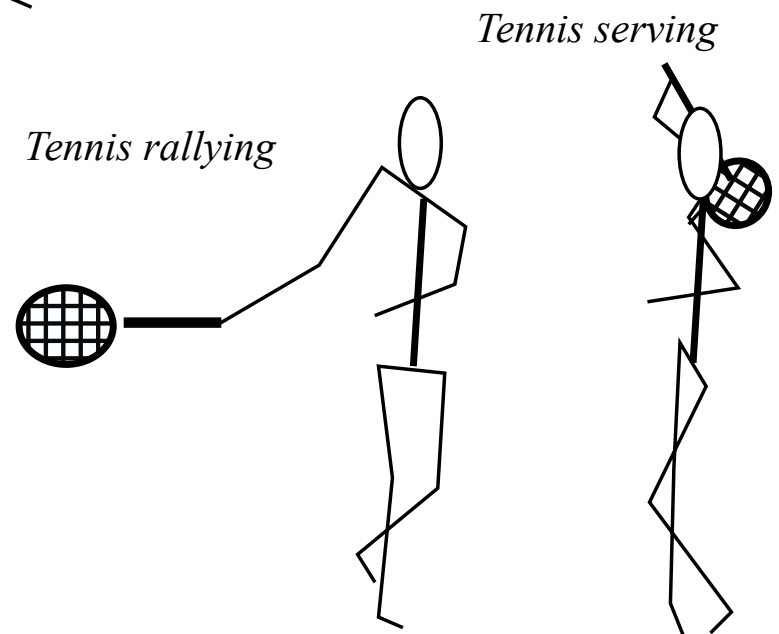
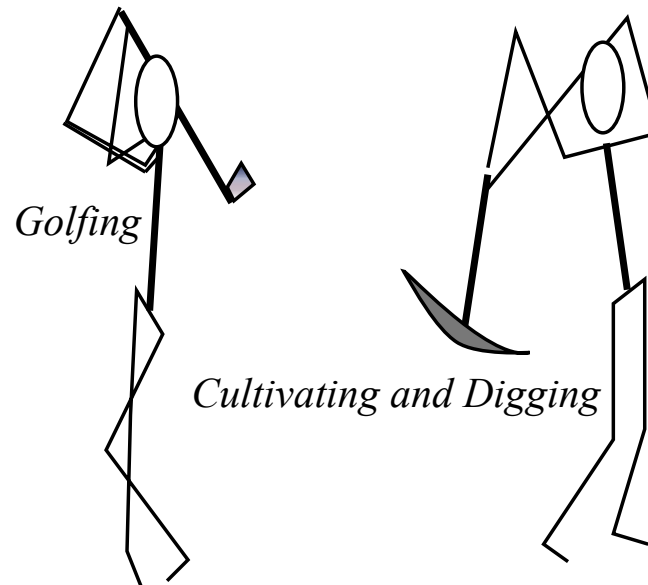
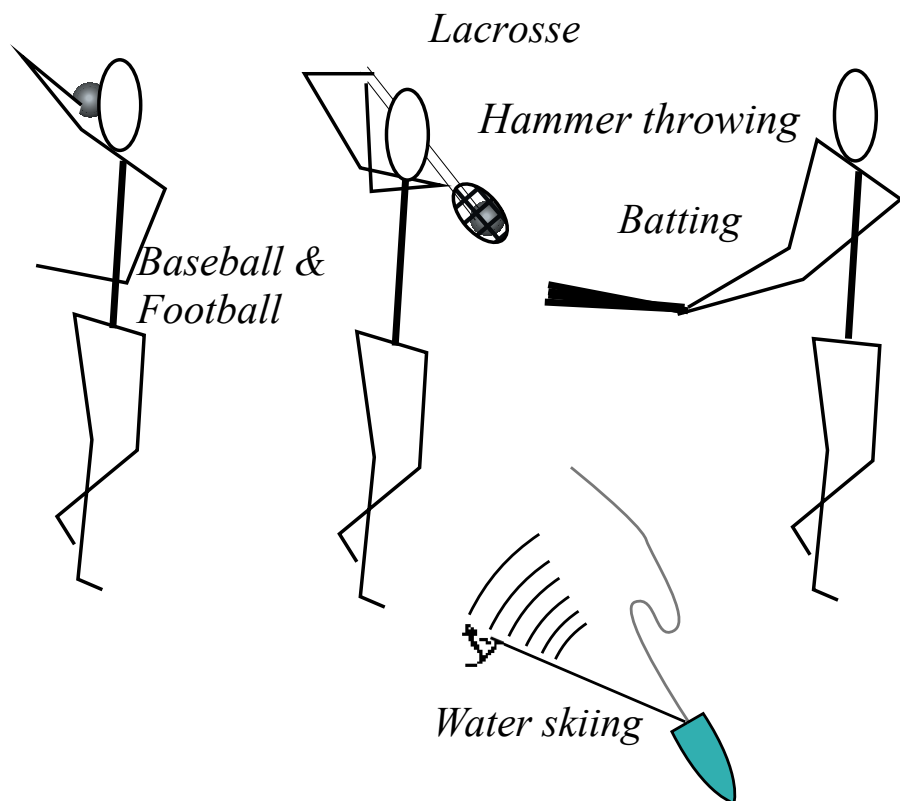

Space Probe “Planetary Slingshot”

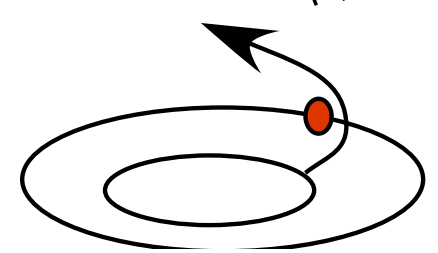

Trebuchet analogy with racquet swing - What we learn

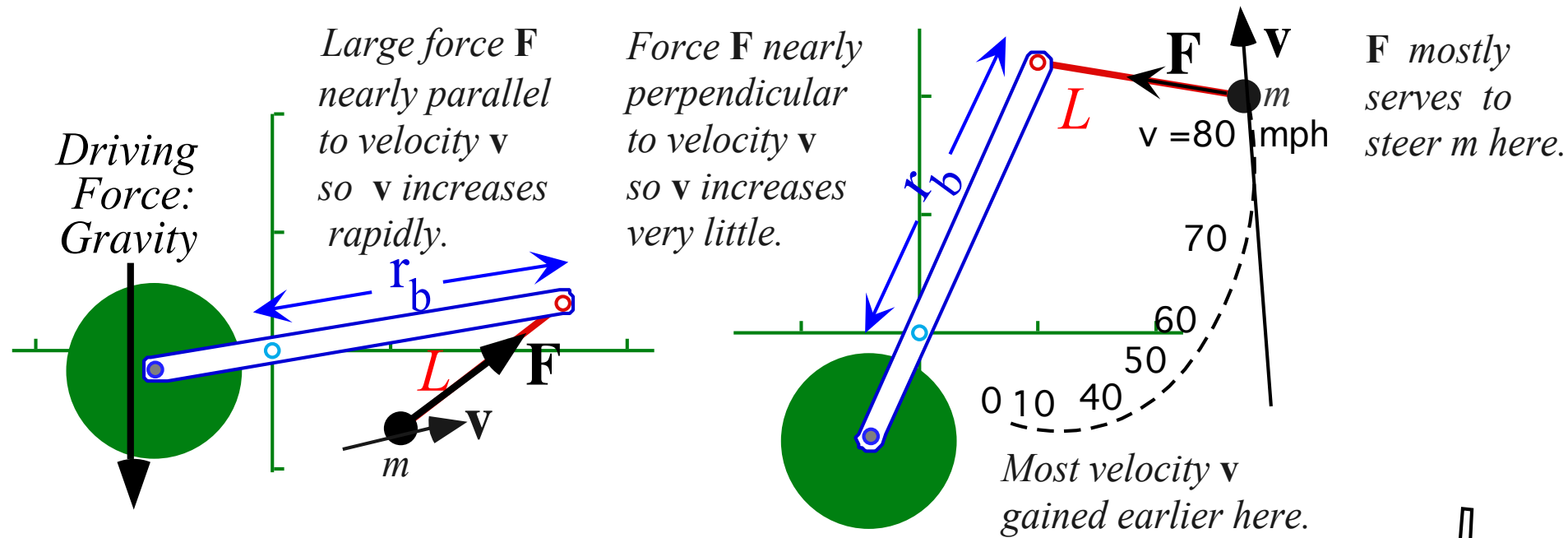

Early on
(Gain the energy/momentum)

Later on
(Steer or guide)

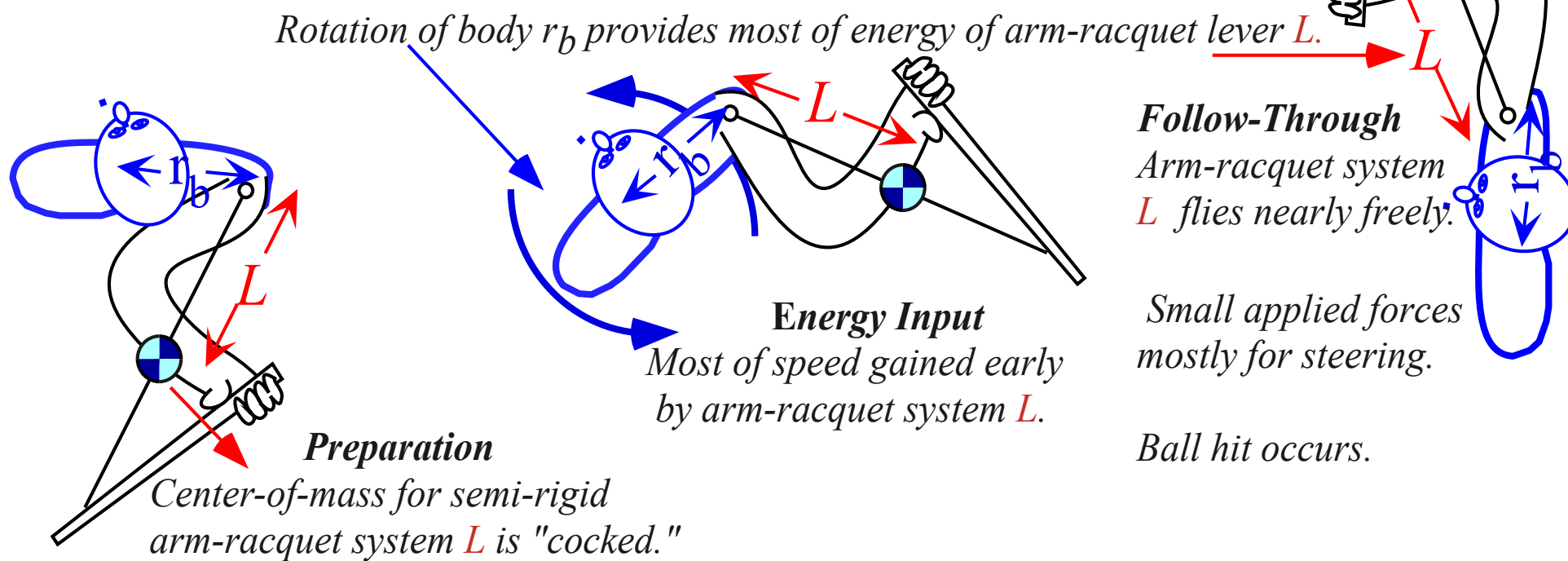

An Opposite to Trebuchet Mechanics- The "Flinger"

<http://www.uark.edu/ua/modphys/markup/TrebuchetWeb.html>

Early on

(Not much happening)

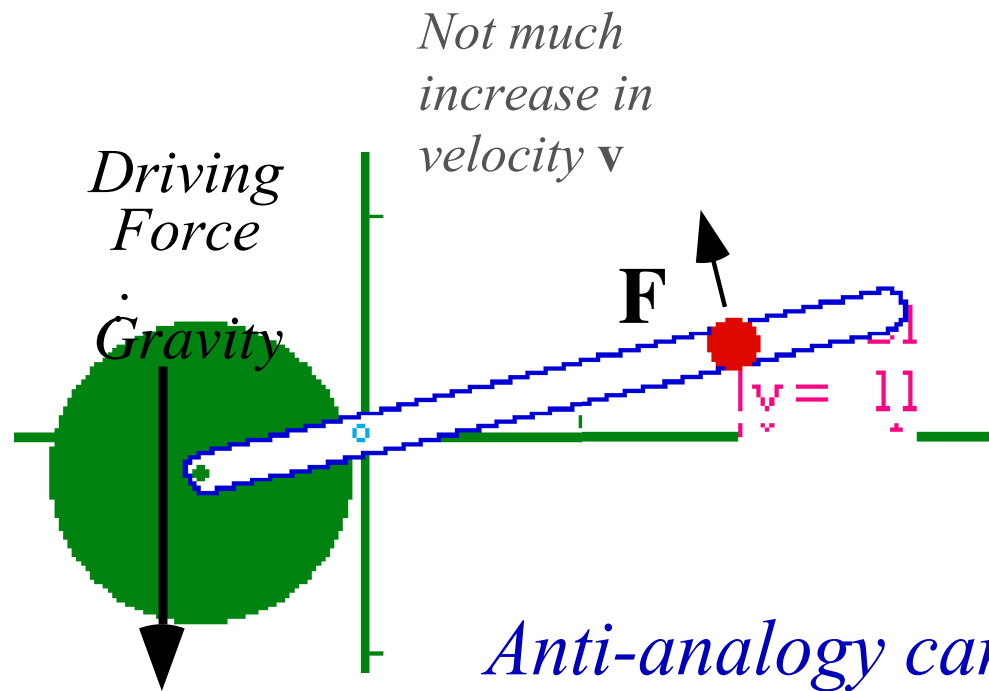

Later on

(Last-minute "cram" for energy)

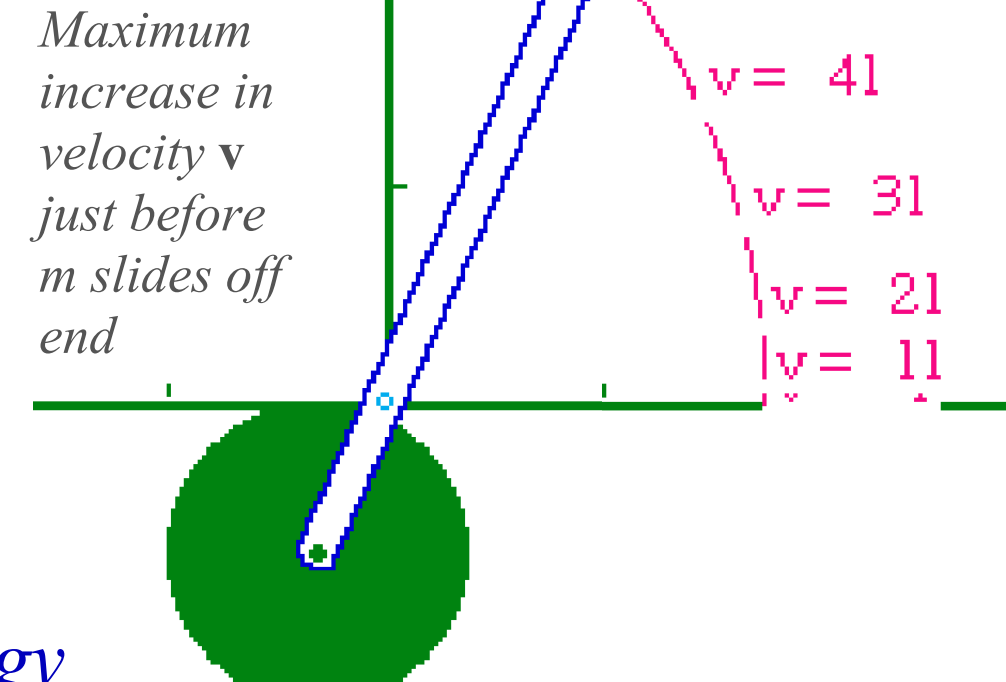

Anti-analogy can be useful pedagogy

Trebuchet-like experiment

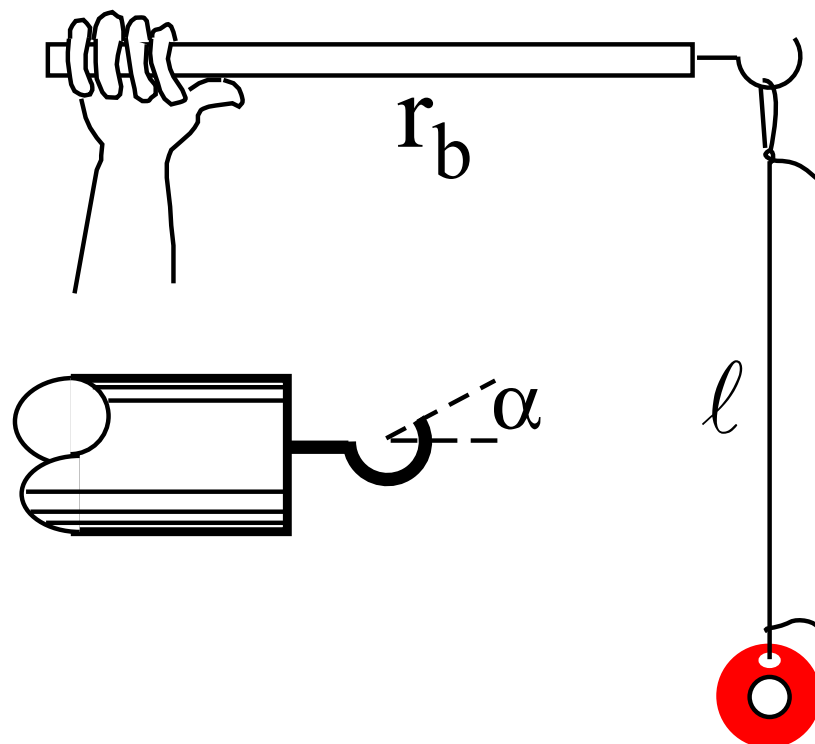

Flinger experiment

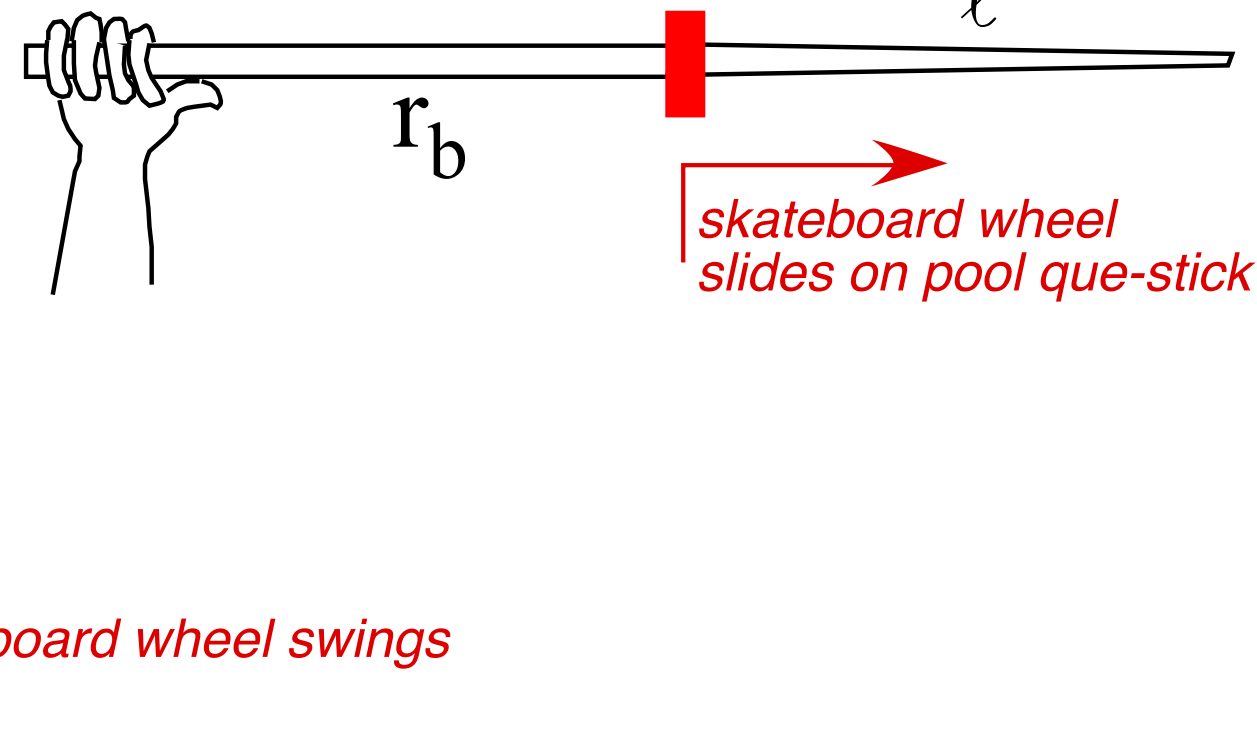

Trebuchet model in rotating beam frame

Assume: Constant beam ω

$$\frac{1}{2} m v_{\text{beam frame}}^2 = V(r_0) - V(r_f) = \frac{1}{2} m \omega^2 r_f^2 - \frac{1}{2} m \omega^2 r_0^2$$

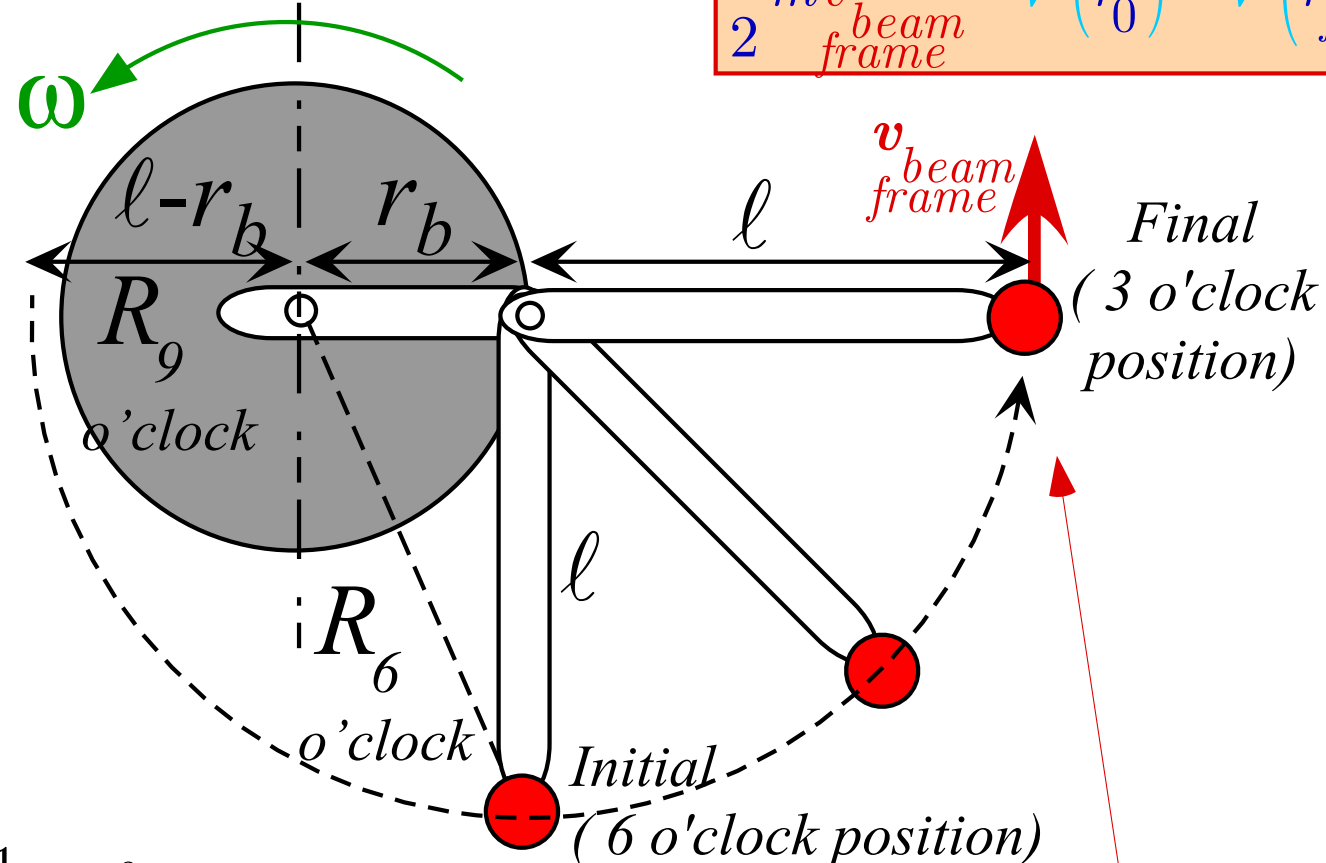

$$\frac{1}{2} m v_{\text{beam frame}}^2 (\text{trebuchet}) = \text{Final Trebuchet } KE_{\text{beam frame}}$$

Flinger model in rotating beam frame

Assume: Constant beam ω

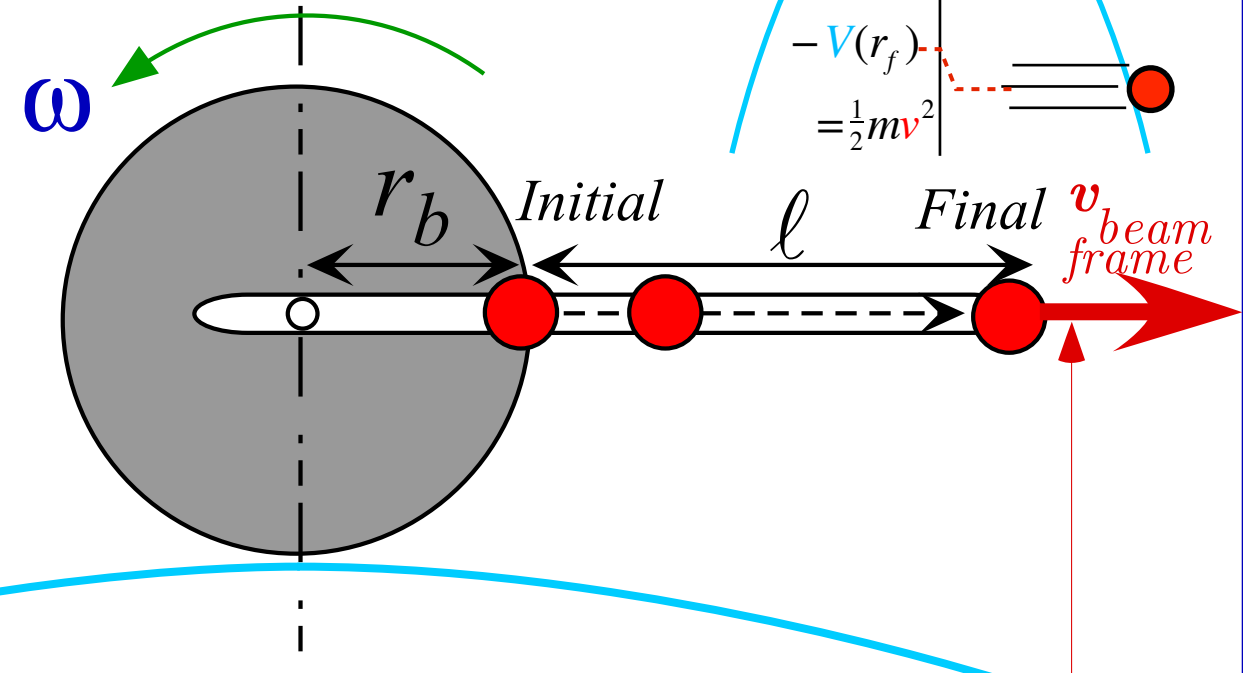
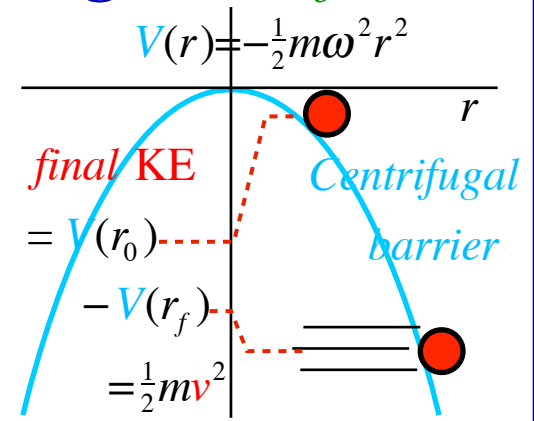

$$\frac{1}{2} m v_{\text{beam frame}}^2 (\text{flinger}) = \text{Final Flinger } KE_{\text{beam frame}}$$

Trebuchet model in rotating beam frame

Assume: Constant beam ω

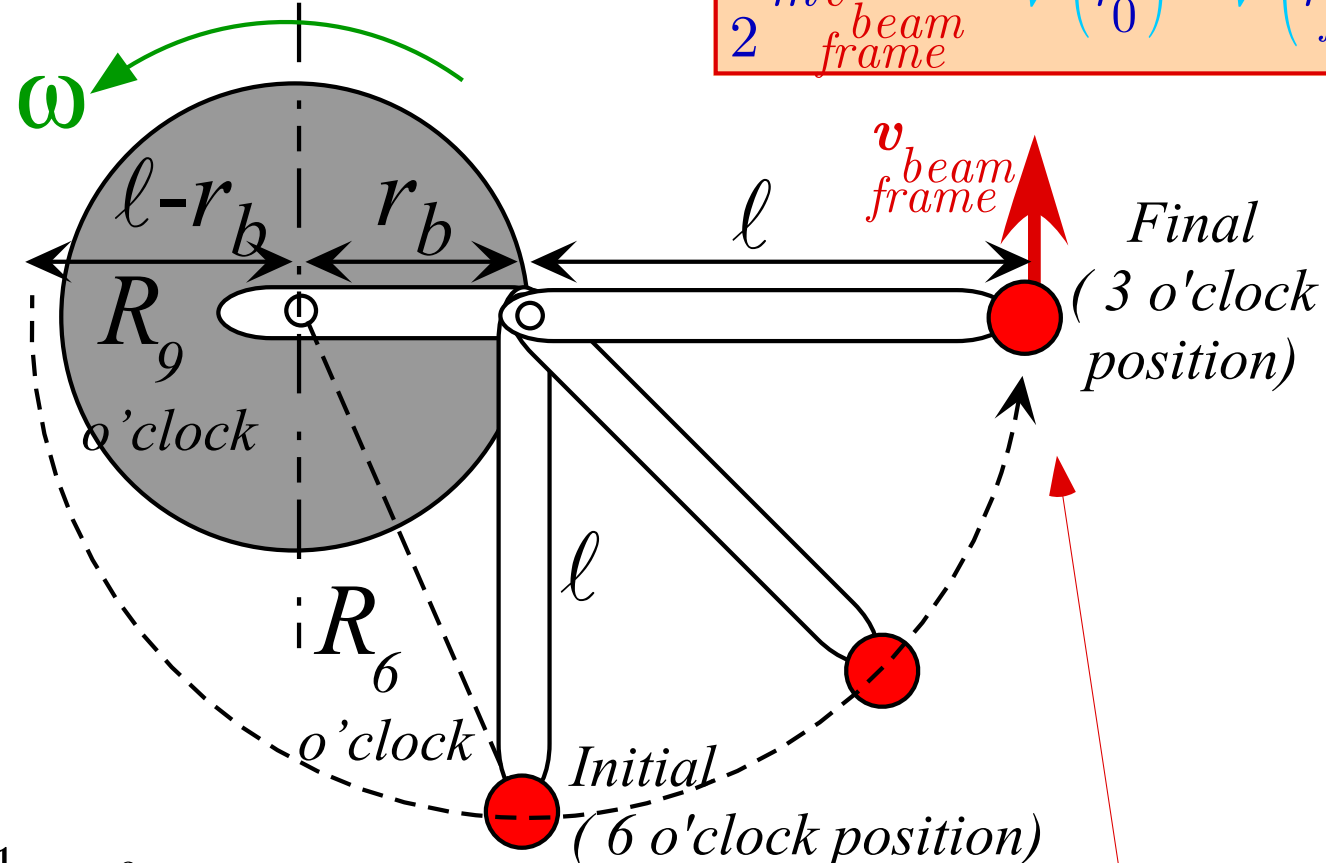

$$\frac{1}{2} m v_{\text{beam frame}}^2 = V(r_0) - V(r_f) = \frac{1}{2} m \omega^2 r_f^2 - \frac{1}{2} m \omega^2 r_0^2$$

$$\frac{1}{2} m v_{\text{beam frame}}^2 (\text{trebuchet}) = \text{Final Trebuchet } KE_{\text{beam frame}}$$

$$\frac{1}{2} m \omega^2 (r_b + l)^2_{\text{Final}} - \frac{1}{2} m \omega^2 (r_b^2 + l^2)_{\text{Initial}} = \frac{1}{2} m \omega^2 (2r_b l)$$

Flinger model in rotating beam frame

Assume: Constant beam ω

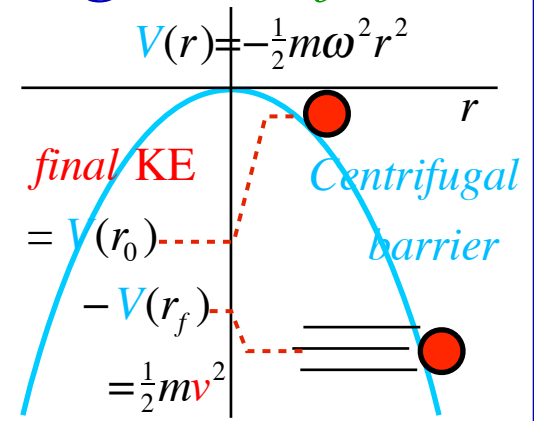
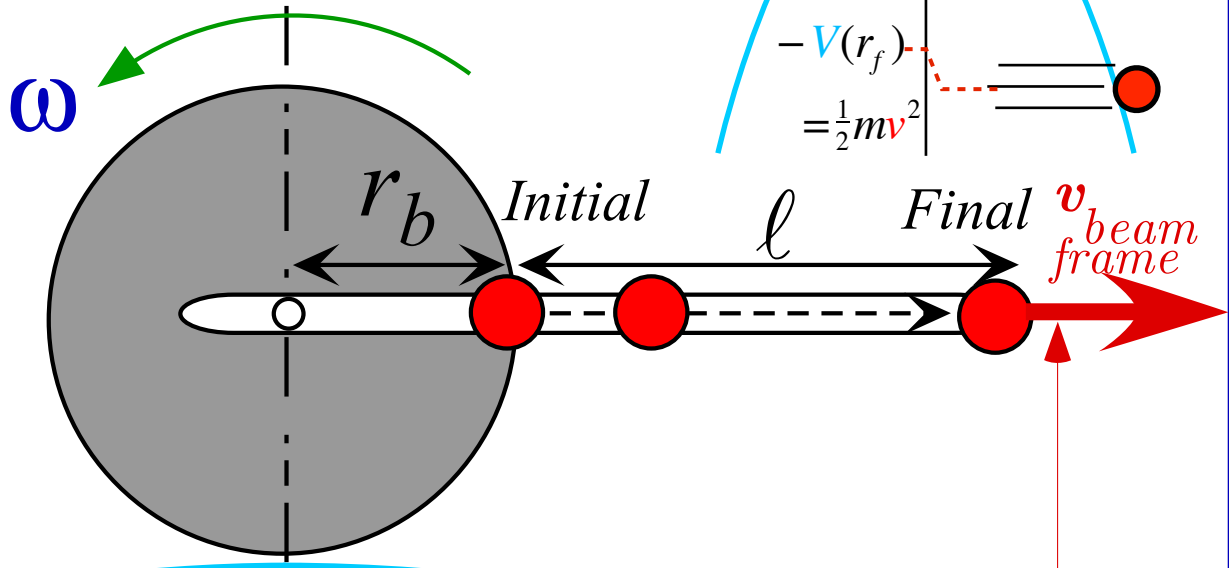

$$\frac{1}{2} m v_{\text{beam frame}}^2 (\text{flinger}) = \text{Final Flinger } KE_{\text{beam frame}}$$

$$\frac{1}{2} m \omega^2 (r_b + l)^2_{\text{Final}} - \frac{1}{2} m \omega^2 r_b^2_{\text{Initial}} = \frac{1}{2} m \omega^2 l (2r_b + l)$$

Trebuchet model in rotating beam frame

Assume: Constant beam ω

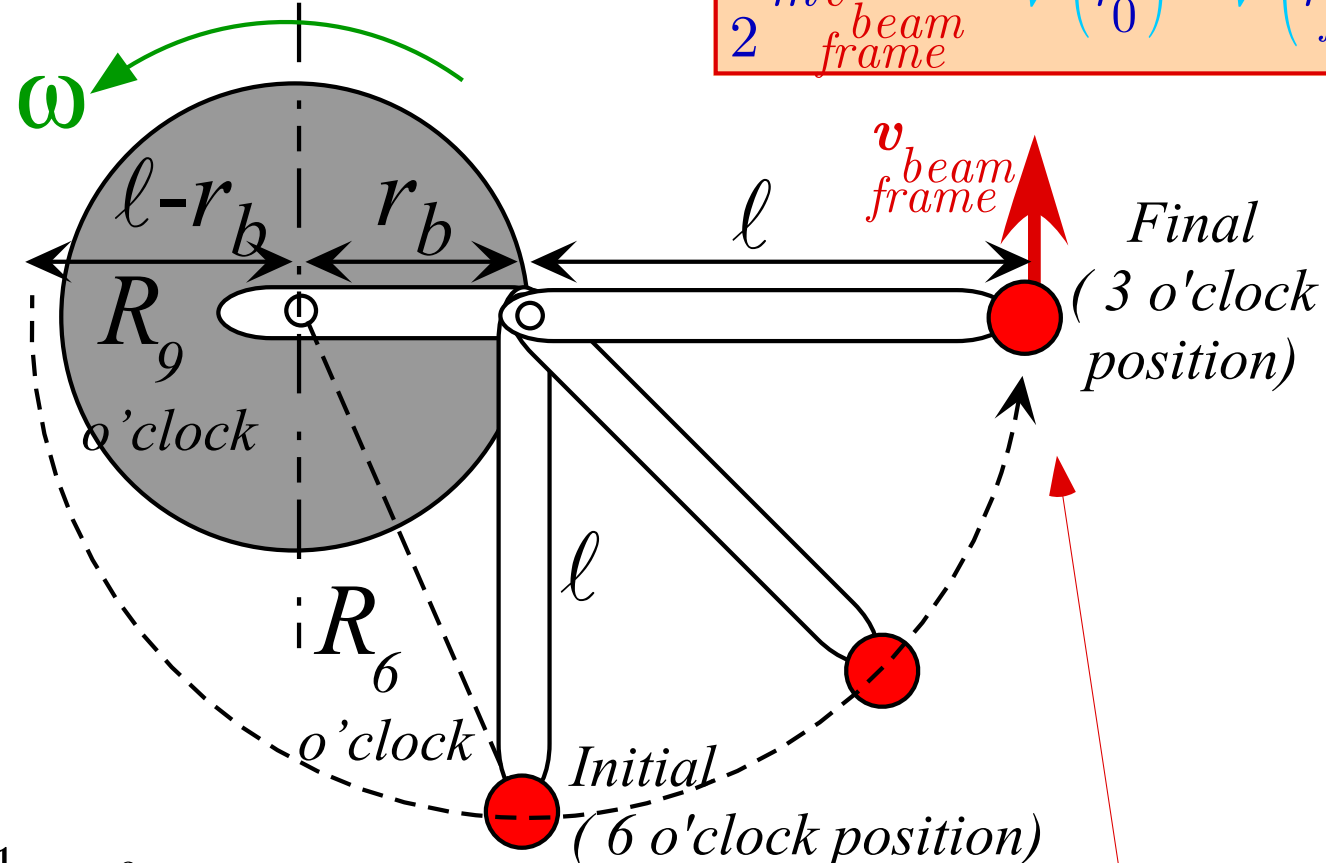

$$\frac{1}{2} m v_{\text{beam frame}}^2 = V(r_0) - V(r_f) = \frac{1}{2} m \omega^2 r_f^2 - \frac{1}{2} m \omega^2 r_0^2$$

$$\frac{1}{2} m v_{\text{beam frame}}^2 (\text{trebuchet}) = \text{Final Trebuchet } KE_{\text{beam frame}}$$

$$\frac{1}{2} m \omega^2 (r_b + l)^2_{\text{Final 3 o'clock}} - \frac{1}{2} m \omega^2 (r_b^2 + l^2)_{\text{Initial 6 o'clock}} = \frac{1}{2} m \omega^2 (2r_b l)$$

$$R_6^2 = r_b^2 + l^2$$

o'clock

Flinger model in rotating beam frame

Assume: Constant beam ω

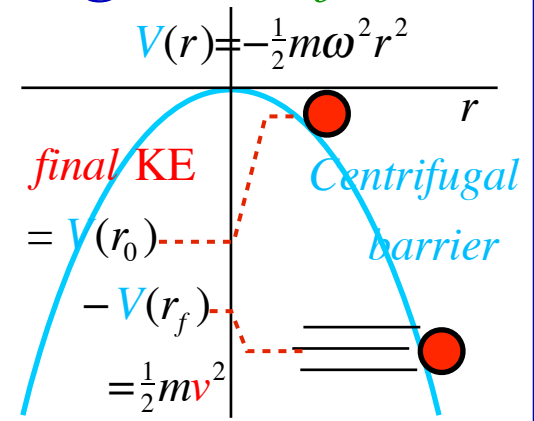
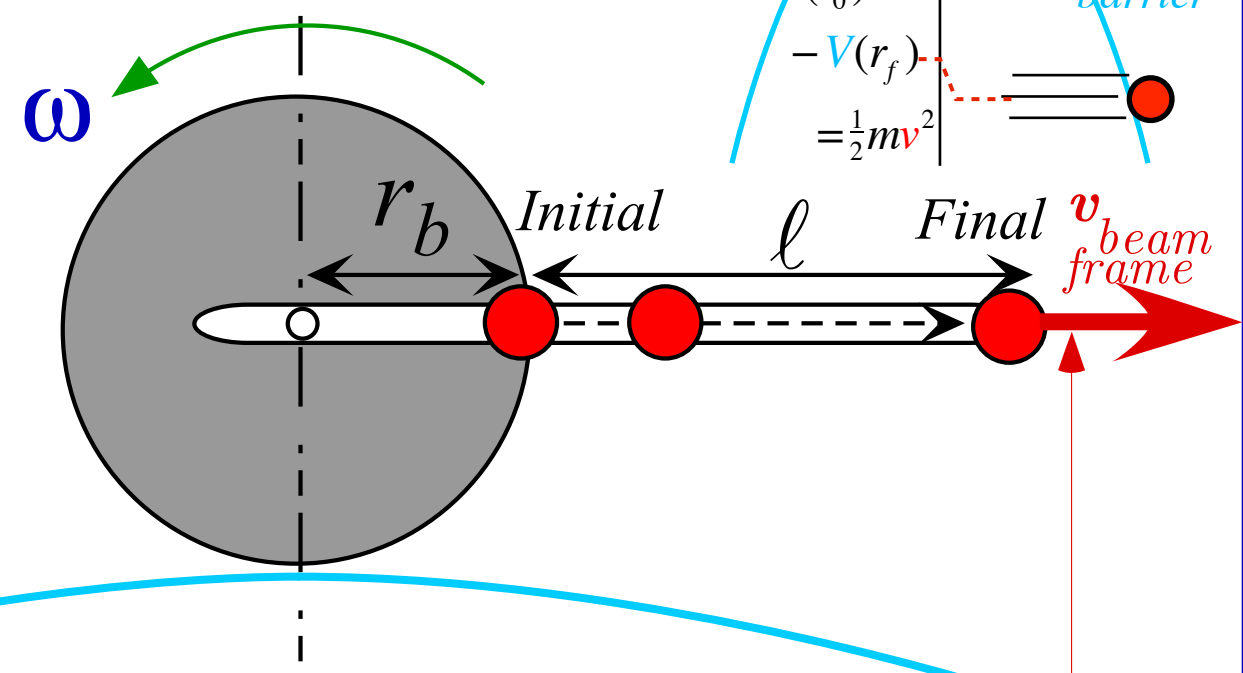

$$\frac{1}{2} m v_{\text{beam frame}}^2 (\text{flinger}) = \text{Final Flinger } KE_{\text{beam frame}}$$

$$\frac{1}{2} m \omega^2 (r_b + l)^2_{\text{Final 3 o'clock}} - \frac{1}{2} m \omega^2 r_b^2_{\text{Initial 3 o'clock}} = \frac{1}{2} m \omega^2 l (2r_b + l)$$

Flinger KE is $\frac{m \omega^2}{2} l^2$ more than 6 o'clock trebuchet but misdirected

Trebuchet model in rotating beam frame

Assume: Constant beam ω

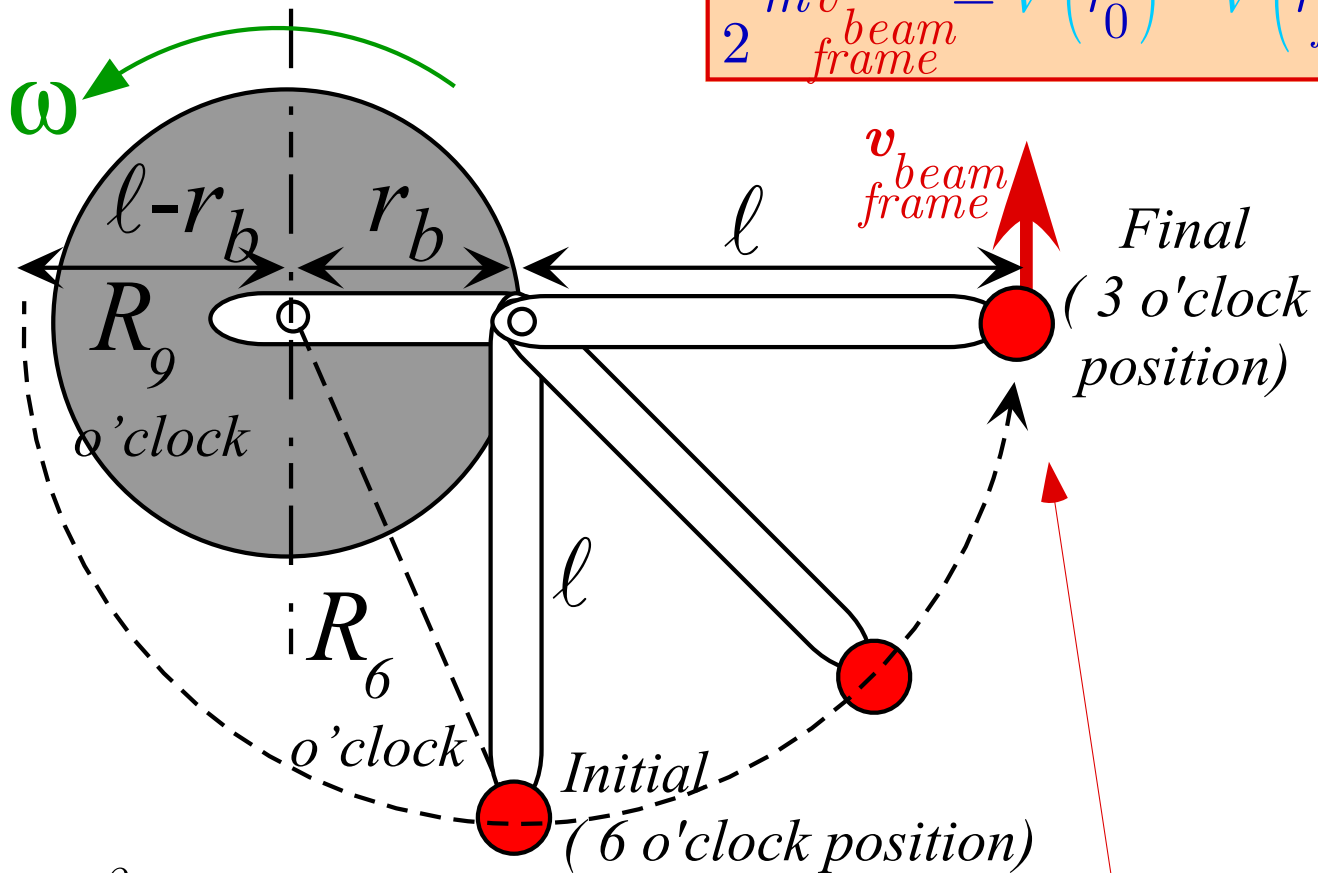

$$\frac{1}{2} m v_{\text{beam frame}}^2 = V(r_0) \quad V(r_f) = \frac{1}{2} m \omega^2 r_f^2 \quad \frac{1}{2} m \omega^2 r_0^2$$

$$\frac{1}{2} m v_{\text{beam frame}}^2 (\text{trebuchet}) = \text{Final Trebuchet } KE_{\text{beam frame}}$$

$$\frac{1}{2} m \omega^2 (r_b + l)^2 \Big|_{\text{Final } 3 \text{ o'clock}} - \frac{1}{2} m \omega^2 (r_b^2 + l^2) \Big|_{\text{Initial } 6 \text{ o'clock}} = \frac{1}{2} m \omega^2 (2r_b l)$$

$$R_6^2 = r_b^2 + l^2$$

o'clock

$$\text{Initial } 9 \text{ o'clock} = \frac{1}{2} m \omega^2 (4r_b l)$$

$$R_9^2 = r_b^2 + l^2 - 2r_b l$$

o'clock

Flinger model in rotating beam frame

Assume: Constant beam ω

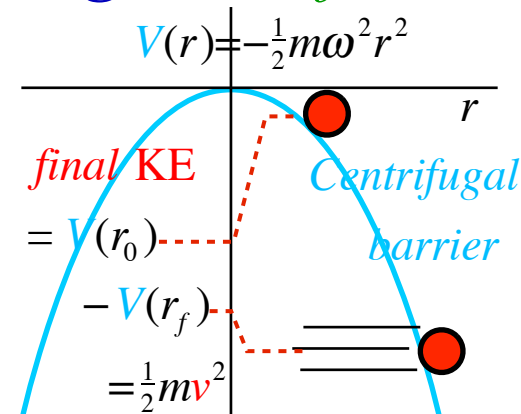
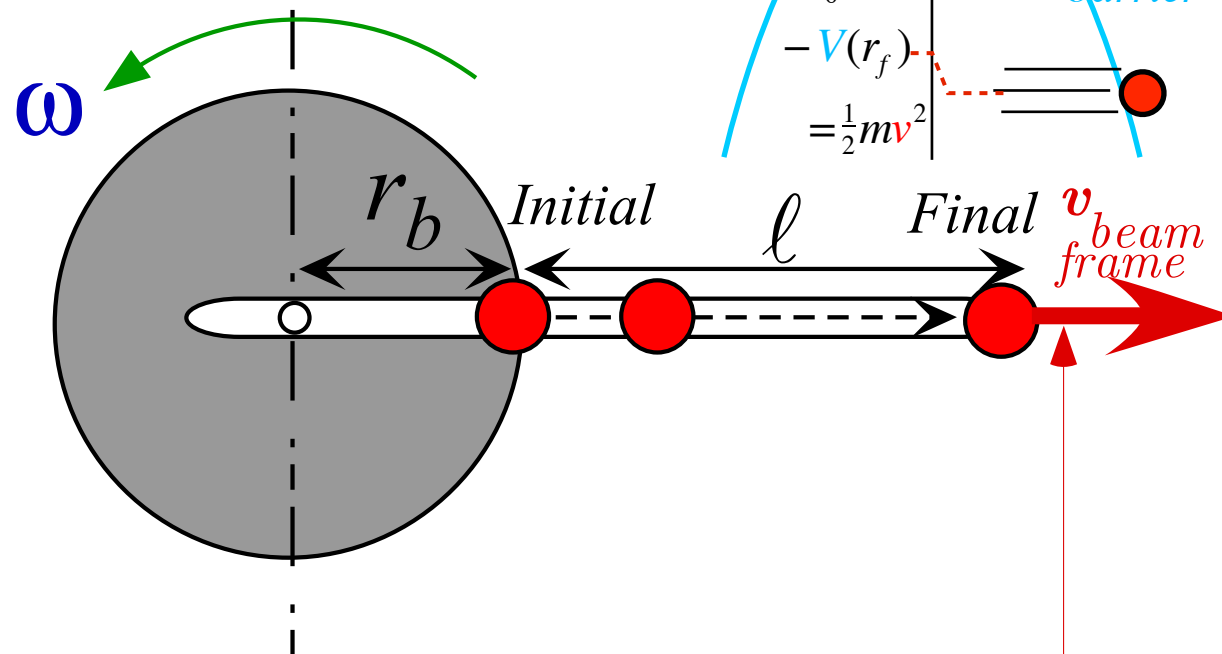

$$\frac{1}{2} m v_{\text{beam frame}}^2 (\text{flinger}) = \text{Final Flinger } KE_{\text{beam frame}}$$

$$\frac{1}{2} m \omega^2 (r_b + l)^2 \Big|_{\text{Final } 3 \text{ o'clock}} - \frac{1}{2} m \omega^2 r_b^2 \Big|_{\text{Initial } 3 \text{ o'clock}} = \frac{1}{2} m \omega^2 l (2r_b + l)$$

Flinger KE is $\frac{m \omega^2}{2} l^2$ more than 6 o'clock trebuchet but misdirected

Flinger KE is $\frac{m \omega^2}{2} (2r_b l - l^2)$ less than 9 o'clock trebuchet and misdirected

Trebuchet model in lab frame

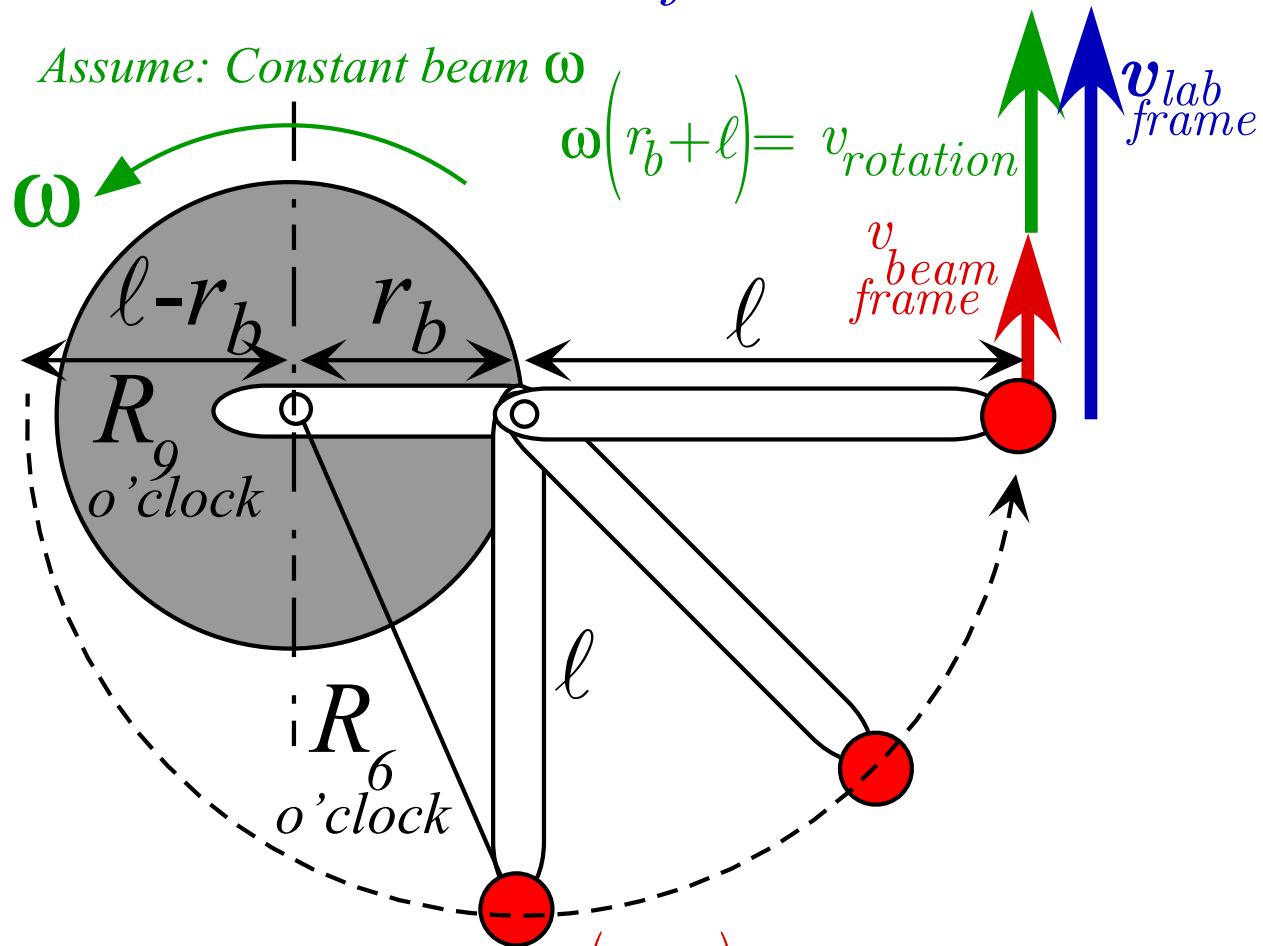

$$v_{beam\ frame}^2 (trebuchet) = \begin{cases} \omega^2 (2r_b l) & \text{half-cocked 6 o'clock} \\ \omega^2 (4r_b l) & \text{fully-cocked 9 o'clock} \end{cases}$$

$$v_{lab\ frame} (trebuchet) = \begin{cases} \omega(r_b + l + \sqrt{2lr_b}) & \text{half-cocked 6 o'clock} \\ \omega(r_b + l + 2\sqrt{lr_b}) & \text{fully-cocked 9 o'clock} \end{cases}$$

$$= \begin{cases} 5.00\omega \\ 5.82\omega \end{cases} = \begin{cases} 5.16\omega \\ 6.00\omega \end{cases} = \begin{cases} 5.00\omega \\ 5.82\omega \end{cases}$$

$(r_b = 2, l = 1), (r_b = 1.5, l = 1.5), (r_b = 1, l = 2)$

Flinger model in lab frame

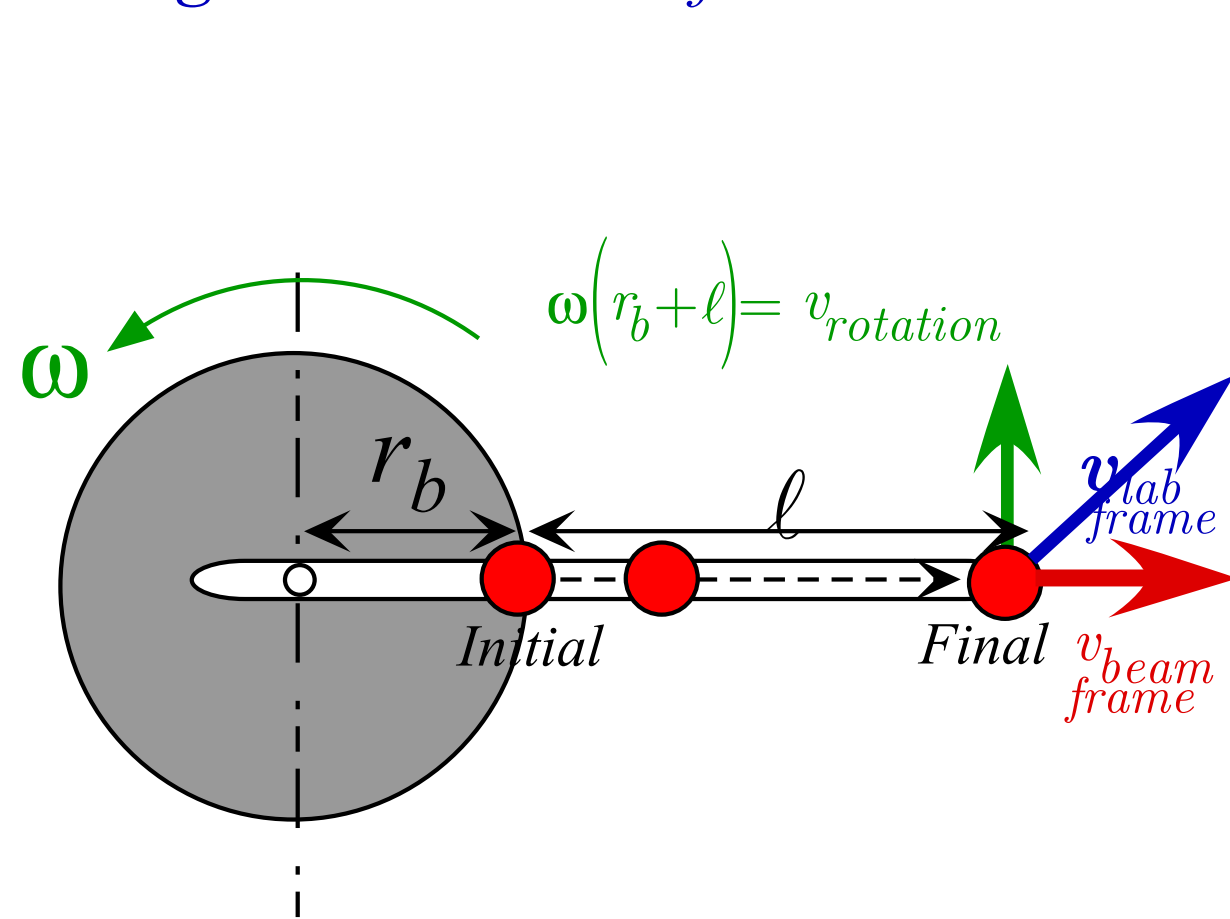

$$v_{beam\ frame}^2 (flinger) = \omega^2 l (2r_b + l)$$

$$v_{lab\ frame} (flinger) = \omega \sqrt{(r_b + l)^2 + l(2r_b + l)} = \omega \sqrt{2(r_b + l)^2 - r_b^2}$$

(compare)

$$= 3.74\omega \quad = 3.96\omega \quad = 4.12\omega$$

$(r_b = 2, l = 1), (r_b = 1.5, l = 1.5), (r_b = 1, l = 2)$

Physics used to be pretty much bi-polar...

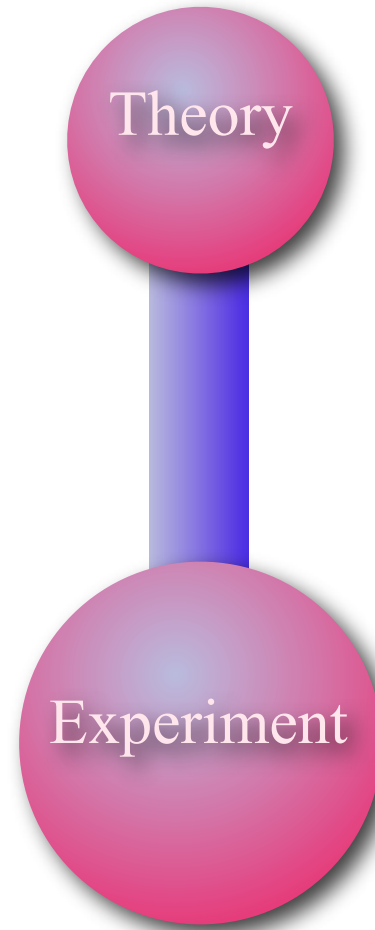

Now that situation is changing...

Many Approaches to Mechanics (Trebuchet Equations)

Each has advantages and disadvantages

- U.S. Approach

Quick'n dirty

Newton F=Ma Equations

Cartesian coordinates

- French Approach

Tres elegant

Lagrange Equations

in Generalized Coordinates

$$F_\ell = \frac{d}{dt} \frac{\partial T}{\partial \dot{q}^\ell} - \frac{\partial T}{\partial q^\ell}$$

- German Approach

Pride and Precision

Riemann Christoffel Equations

in Differential Manifolds

$$F^k = \ddot{q}^k + \Gamma_{mn}^k \dot{q}^m \dot{q}^n$$

- Anglo-Irish Approach

Powerfully Creative

Hamilton's Equations

Phase Space $\dot{p}_j = -\frac{\partial H}{\partial q^j}, \quad \dot{q}^k = \frac{\partial H}{\partial p^k}.$

- Unified Approach

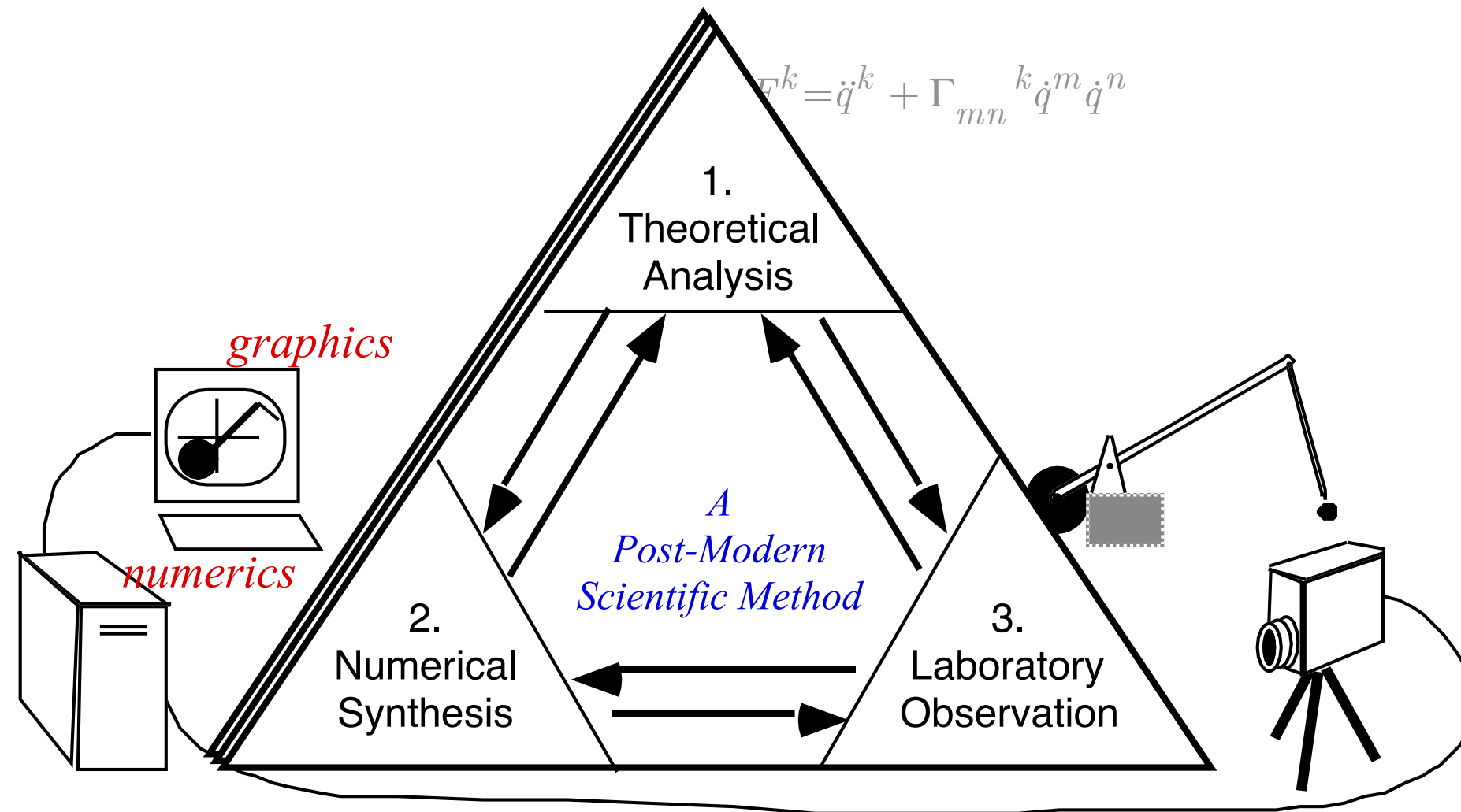

All approaches have one thing in common:

The Art of Approximation

Physics lives and dies by the art of approximate models and analogs.

$$dS = Ldt = p_\mu dq^\mu - Hdt$$

Hamilton-Jacobi-Poincare: $p_\mu = \frac{\partial S}{\partial q^\mu}, -H = \frac{\partial S}{\partial t}$

Force, Work, and Acceleration

$$dW = F_X dX + F_Y dY + F_x dx + F_y dy$$

$$= M\ddot{X} dX + M\ddot{Y} dY + m\ddot{x} dx + m\ddot{y} dy$$

Write work-sums in columns: (Using GCC $d\theta$ and $d\phi$ in Jacobian)

$$dW = F_X dX = M\ddot{X} dX = F_X \frac{\partial X}{\partial \theta} d\theta + F_X \frac{\partial X}{\partial \phi} d\phi = M\ddot{X} \frac{\partial X}{\partial \theta} d\theta + M\ddot{X} \frac{\partial X}{\partial \phi} d\phi$$

$$+ F_Y dY + M\ddot{Y} dY + F_Y \frac{\partial Y}{\partial \theta} d\theta + F_Y \frac{\partial Y}{\partial \phi} d\phi + M\ddot{Y} \frac{\partial Y}{\partial \theta} d\theta + M\ddot{Y} \frac{\partial Y}{\partial \phi} d\phi$$

$$+ F_x dx + m\ddot{x} dx + F_x \frac{\partial x}{\partial \theta} d\theta + F_x \frac{\partial x}{\partial \phi} d\phi + m\ddot{x} \frac{\partial x}{\partial \theta} d\theta + m\ddot{x} \frac{\partial x}{\partial \phi} d\phi$$

$$+ F_y dy + m\ddot{y} dy + F_y \frac{\partial y}{\partial \theta} d\theta + F_y \frac{\partial y}{\partial \phi} d\phi + m\ddot{y} \frac{\partial y}{\partial \theta} d\theta + m\ddot{y} \frac{\partial y}{\partial \phi} d\phi$$

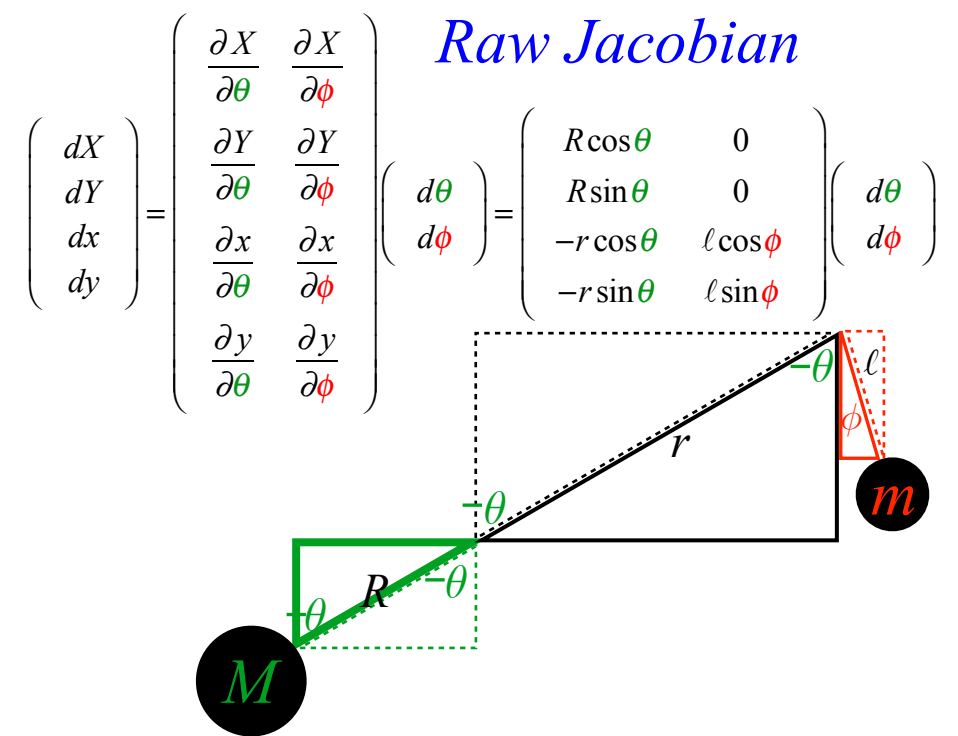

Lagrange trickery:

STEP D Add up first and last columns for each variable θ and ϕ for: $T = \frac{M\dot{X}^2}{2} + \frac{M\dot{Y}^2}{2} + \frac{M\dot{x}^2}{2} + \frac{M\dot{y}^2}{2}$

Let: $F_X \frac{\partial X}{\partial \theta} + F_Y \frac{\partial Y}{\partial \theta} + F_x \frac{\partial x}{\partial \theta} + F_y \frac{\partial y}{\partial \theta} \equiv F_\theta = \frac{d}{dt} \frac{\partial T}{\partial \dot{\theta}} - \frac{\partial T}{\partial \theta}$

Let: $F_X \frac{\partial X}{\partial \phi} + F_Y \frac{\partial Y}{\partial \phi} + F_x \frac{\partial x}{\partial \phi} + F_y \frac{\partial y}{\partial \phi} \equiv F_\phi = \frac{d}{dt} \frac{\partial T}{\partial \dot{\phi}} - \frac{\partial T}{\partial \phi}$

Completes derivation of Lagrange covariant-force equation for each GCC variable θ and ϕ .

$$F_X R \cos \theta + F_Y R \sin \theta - F_x r \cos \theta - F_y r \sin \theta$$

$$\equiv F_\theta = \frac{d}{dt} \frac{\partial T}{\partial \dot{\theta}} - \frac{\partial T}{\partial \theta}$$

Add F_θ gravity given
 $(F_X = 0, F_Y = -Mg)$
 $(F_x = 0, F_y = -mg)$

$$F_\theta = \frac{d}{dt} \frac{\partial T}{\partial \dot{\theta}} - \frac{\partial T}{\partial \theta} = -MgR \sin \theta + mgr \sin \theta$$

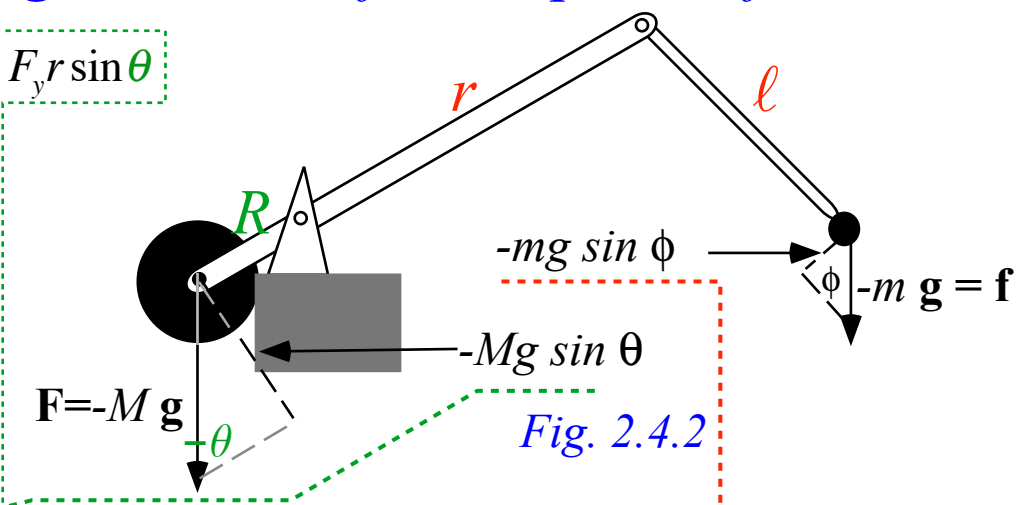

$$F_X \cdot 0 + F_Y \cdot 0 + F_x \ell \cos \phi + F_y \ell \sin \phi$$

$$\equiv F_\phi = \frac{d}{dt} \frac{\partial T}{\partial \dot{\phi}} - \frac{\partial T}{\partial \phi}$$

Add F_ϕ gravity given
 $(F_X = 0, F_Y = -Mg)$
 $(F_x = 0, F_y = -mg)$

$$F_\phi = \frac{d}{dt} \frac{\partial T}{\partial \dot{\phi}} - \frac{\partial T}{\partial \phi} = -mgl \sin \phi$$

These are competing torques on main beam R...

... and a torque on throwing lever ℓ

Forces: total, genuine, potential, and/or fictitious

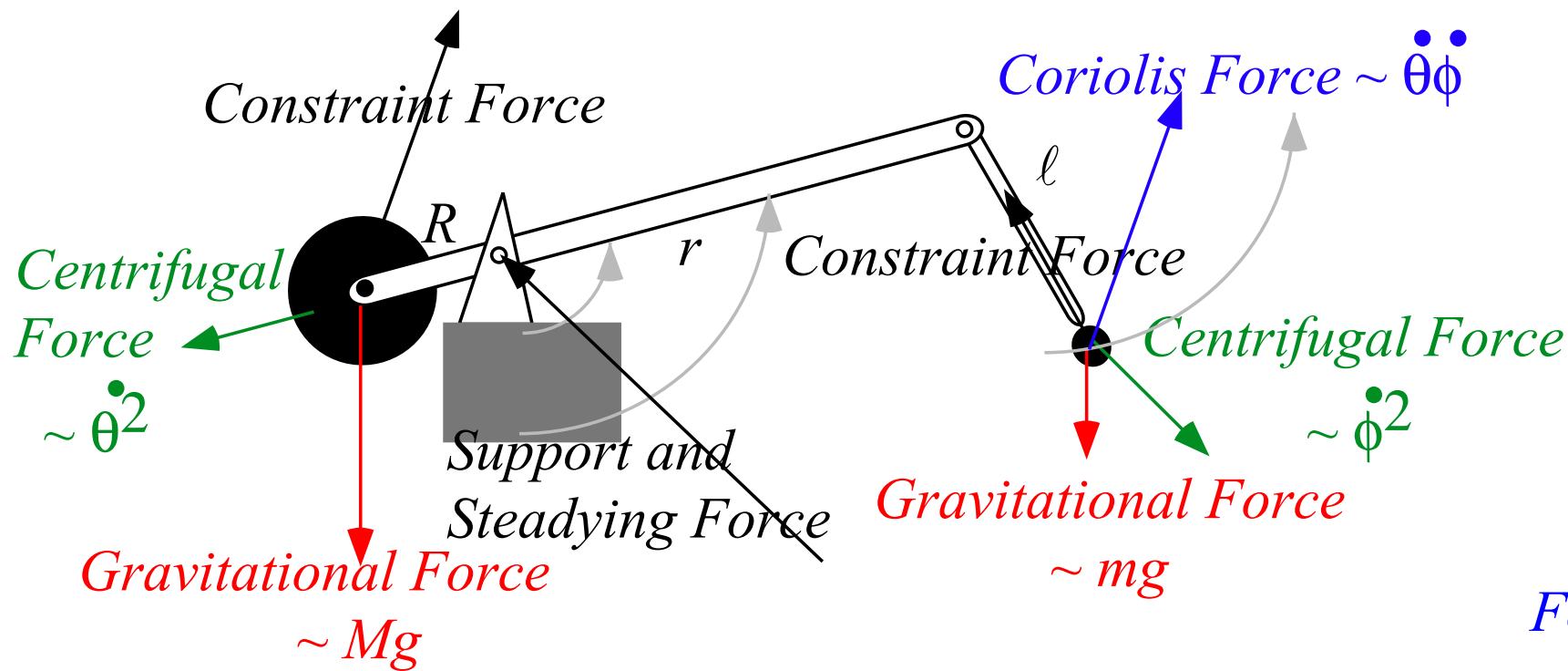

Acceleration and 'Fictitious' Forces:

Coriolis

Centrifugal

Applied 'Real' Forces:

*Gravity
Stimuli
Friction...*

Constraint 'Internal' Forces:

*Stresses
Support...*

(Do not contribute. Do no work.)

For conservative forces

where: $F_{\theta} = -\frac{\partial V}{\partial \theta}$ and: $\frac{\partial V}{\partial \dot{\theta}} = 0$
 $F_{\phi} = -\frac{\partial V}{\partial \phi}$ and: $\frac{\partial V}{\partial \dot{\phi}} = 0$

$$\dot{p}_{\theta} = \frac{d}{dt} \frac{\partial T}{\partial \dot{\theta}} = \frac{\partial T}{\partial \theta} + F_{\theta} + 0$$

$$\dot{p}_{\phi} = \frac{d}{dt} \frac{\partial T}{\partial \dot{\phi}} = \frac{\partial T}{\partial \phi} + F_{\phi} + 0$$

Lagrange Force equations
 (See also derivation Eq. (2.4.7) on p. 23, Unit 2)

$$p_{\theta} = \frac{\partial L}{\partial \dot{\theta}} \quad \dot{p}_{\theta} = \frac{\partial L}{\partial \theta}$$

$$p_{\phi} = \frac{\partial L}{\partial \dot{\phi}} \quad \dot{p}_{\phi} = \frac{\partial L}{\partial \phi}$$

Lagrange Potential equations
 $L = T - V$

Fig. 2.5.2 (modified)

Compare to derivation Eq (12.25a) in Ch. 12 of Unit 1 and Eq. (3.5.10) in Unit 3.