

Group Theory in Quantum Mechanics

Based on AMOP Lectures 14-20

Lecture 26 (4.28.15)

Introduction to Rotational Eigenstates and Spectra II

(Int.J.Mol.Sci, 14, 714(2013) p.755-774 , QTCA Unit 7 Ch. 21-25)

(PSDS - Ch. 5, 7)

Review :

Symmetric rigid quantum rotor analysis of $R(2)$ Hamiltonian $\mathbf{H} = B\mathbf{J}_x^2 + B\mathbf{J}_y^2 + C\mathbf{J}_z^2$

Rotational Energy Surfaces (RE or RES) and $R(3) \sim U(2)$ representations

Asymmetric rigid quantum rotor analysis of D_2 Hamiltonian $\mathbf{H} = A\mathbf{J}_x^2 + B\mathbf{J}_y^2 + C\mathbf{J}_z^2$

RES and Multipole \mathbf{T}_q^k tensor expansions

Atomic or molecular $R(3)$ ℓ -level or $2\ell+1$ -multiplet splitting

$R(3) \supset D_2$ character analysis of ℓ -level or $2\ell+1$ -multiplet splitting in D_2

Detailed angular momentum operator analysis for $J=1-2$ for D_2 symmetry

Asymmetric rotor levels and RES plots for high- J

Octahedral semi-rigid quantum rotor analysis of O_h Hamiltonian $\mathbf{H} = B\mathbf{J} \cdot \mathbf{J} + t_{044}\mathbf{T}^{[4]}$

Spherical rotor levels and RES plots of O_h tensor eigenvalues

$R(3) \subset O(3) \supset O_h \supset O$ character analysis of ℓ -level or $2\ell+1$ -multiplet splitting in O

SF_6 spectral fine structure P(88)

CF_4 spectral fine structure P(54)

As of April 3, 2014

Links to the current Harter-Soft LearnIt web apps for Physics

Bold links have default redirect pages. *Italics* are not yet meant for production. **Red: the final stages of testing.**

List of *production* Harter-Soft Web Apps & Textbooks (For public)

[Classical Mechanics with a Bang!](http://www.uark.edu/ua/modphys/markup/CMwBangWeb.html) - URL is "<http://www.uark.edu/ua/modphys/markup/CMwBangWeb.html>"
[Quantum Theory for the Computer Age](http://www.uark.edu/ua/modphys/markup/QTCASWeb.html) - URL is "<http://www.uark.edu/ua/modphys/markup/QTCASWeb.html>"
[LearnIt Web Applications](http://www.uark.edu/ua/modphys/markup/LearnItWeb.html) - URL is "<http://www.uark.edu/ua/modphys/markup/LearnItWeb.html>"

Individual web-apps for current classes:

[BohrIt](http://www.uark.edu/ua/modphys/markup/BohrItWeb.html) - Production; URL is "<http://www.uark.edu/ua/modphys/markup/BohrItWeb.html>"
[BounceIt](http://www.uark.edu/ua/modphys/markup/BounceItWeb.html) - Production; URL is "<http://www.uark.edu/ua/modphys/markup/BounceItWeb.html>"
[BoxIt](http://www.uark.edu/ua/modphys/markup/BoxItWeb.html) - Production; URL is "<http://www.uark.edu/ua/modphys/markup/BoxItWeb.html>"
[Coult](http://www.uark.edu/ua/modphys/markup/CoultWeb.html) - Production; URL is "<http://www.uark.edu/ua/modphys/markup/CoultWeb.html>"
[Cycloidulum](http://www.uark.edu/ua/modphys/markup/CycloidulumWeb.html) - Production; URL is "<http://www.uark.edu/ua/modphys/markup/CycloidulumWeb.html>"
[JerkIt](http://www.uark.edu/ua/modphys/markup/JerkItWeb.html) - Production; URL is "<http://www.uark.edu/ua/modphys/markup/JerkItWeb.html>"
[MolVibes](http://www.uark.edu/ua/modphys/markup/MolVibesWeb.html) - Production; URL is "<http://www.uark.edu/ua/modphys/markup/MolVibesWeb.html>"
[Pendulum](http://www.uark.edu/ua/modphys/markup/PendulumWeb.html) - Production; URL is "<http://www.uark.edu/ua/modphys/markup/PendulumWeb.html>"
[QuantIt](http://www.uark.edu/ua/modphys/markup/QuantItWeb.html) - Production; URL is "<http://www.uark.edu/ua/modphys/markup/QuantItWeb.html>"

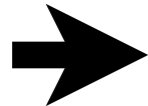

The old relativity website (2005):

[Relativity - Pirelli Entrant](http://www.uark.edu/ua/pirelli) - Production; URL is "<http://www.uark.edu/ua/pirelli>" or "<http://www.uark.edu/ua/pirelli/html/default.html>"

Newer relativity web-apps currently being developed (2013-)

[RelativIt](http://www.uark.edu/ua/modphys/markup/RelativItWeb.html) Production; URL is "<http://www.uark.edu/ua/modphys/markup/RelativItWeb.html>"
[RelaWavity](http://www.uark.edu/ua/modphys/markup/RelaWavityWeb.html) Production; URL is "<http://www.uark.edu/ua/modphys/markup/RelaWavityWeb.html>"

Additional classical wep-apps:

[Trebuchet](http://www.uark.edu/ua/modphys/markup/TrebuchetWeb.html) Production; URL is "<http://www.uark.edu/ua/modphys/markup/TrebuchetWeb.html>"
[WaveIt](http://www.uark.edu/ua/modphys/markup/WaveItWeb.html) Production; URL is "<http://www.uark.edu/ua/modphys/markup/WaveItWeb.html>"

Link to master list of all Harter-Soft Web Apps & Textbooks (Prod, Testing, & Developement)

<http://www.uark.edu/ua/modphys/testing/markup/Harter-SoftWebApps.html>

Review :

→ *Symmetric rigid quantum rotor analysis of $R(2)$ Hamiltonian $\mathbf{H} = B\mathbf{J}_x^2 + B\mathbf{J}_y^2 + C\mathbf{J}_z^2$ Rotational Energy Surfaces (RE or RES) and $R(3) \sim U(2)$ representations* ←

Asymmetric rigid quantum rotor analysis of D_2 Hamiltonian $\mathbf{H} = A\mathbf{J}_x^2 + B\mathbf{J}_y^2 + C\mathbf{J}_z^2$

RES and Multipole \mathbf{T}_q^k tensor expansions

Atomic or molecular $R(3)$ ℓ -level or $2\ell+1$ -multiplet splitting

$R(3) \supset D_2$ character analysis of ℓ -level or $2\ell+1$ -multiplet splitting in D_2

Detailed angular momentum operator analysis for $J=1-2$ for D_2 symmetry

Asymmetric rotor levels and RES plots

Octahedral semi-rigid quantum rotor analysis of O_h Hamiltonian $\mathbf{H} = B\mathbf{J} \cdot \mathbf{J} + t_{044}\mathbf{T}^{[4]}$

Spherical rotor levels and RES plots of O_h tensor eigenvalues

$R(3) \subset O(3) \supset O_h \supset O$ character analysis of ℓ -level or $2\ell+1$ -multiplet splitting in O

SF_6 spectral fine structure

CF_4 spectral fine structure

Rotational Energy Surfaces (RE or RES) applied to symmetric quantum rotor analysis

Plot Hamiltonian $H = B\mathbf{J}^2 + (C - B)\mathbf{J}_z^2$ radially as

$$H(\Theta) = BJ(J+1) + (C - B)J(J+1)\cos^2 \Theta$$

where: $\mathbf{J}_z = |\mathbf{J}| \cos \Theta$
 $= \sqrt{J(J+1)} \cos \Theta$

$$\left| \begin{matrix} j \\ m, n \end{matrix} \right\rangle$$

Conventional notation: $n=K$

$$H(\Theta_K^J) = BJ(J+1) + (C - B)J(J+1)\cos^2 \Theta_K^J$$

$$= BJ(J+1) + (C - B)K^2$$

(Here this gives exact quantum eigenvalues!)

LAB $m=M$ BOD $n=K$

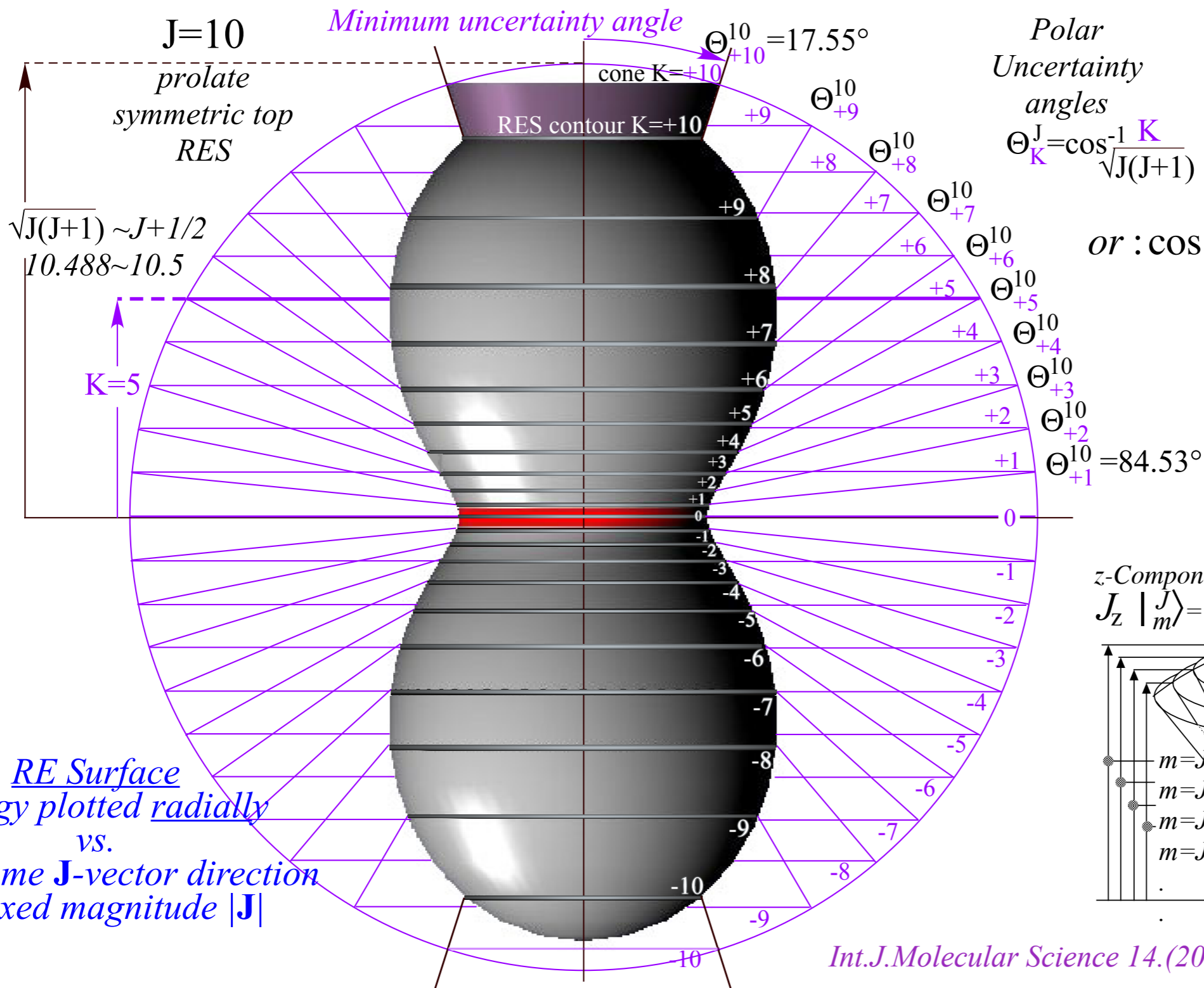

or: $\cos \Theta_K^J = \frac{K}{\sqrt{J(J+1)}}$

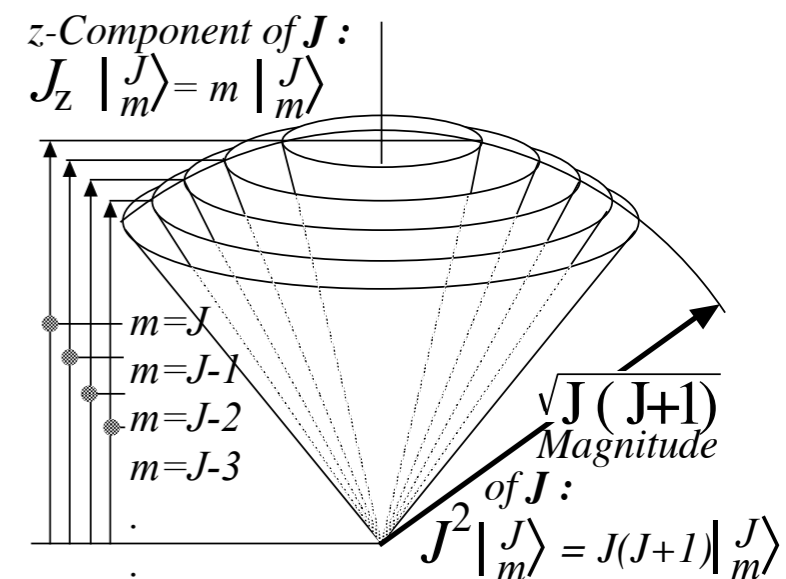

Int.J.Molecular Science 14.(2013) Fig.1 p. 730

R(3)~U(2) representations applied to molecular symmetric rotor analysis

$$\mathbf{H}_{\text{symmetric top}} = B\mathbf{J}_{\bar{X}}^2 + B\mathbf{J}_{\bar{Y}}^2 + B\mathbf{J}_{\bar{Z}}^2 + (A - B)\mathbf{J}_{\bar{Z}}^2 = B\mathbf{J} \cdot \mathbf{J} + (A - B)\mathbf{J}_{\bar{Z}}^2$$

Kinetic energy inertial coefficients:

$$B = \frac{1}{2I_{\bar{X}}} = C = \frac{1}{2I_{\bar{Y}}}, A = \frac{1}{2I_{\bar{Z}}}$$

Eigensolution equations:

$$\begin{aligned} \mathbf{H}_{\text{symmetric top}} |j, m, n\rangle &= B\mathbf{J} \cdot \mathbf{J} + (A - B)\mathbf{J}_{\bar{Z}}^2 |j, m, n\rangle \\ &= [BJ(J + 1) + (A - B)n^2] |j, m, n\rangle \end{aligned}$$

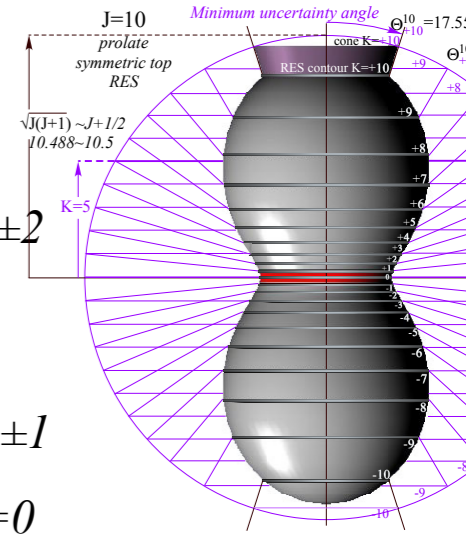
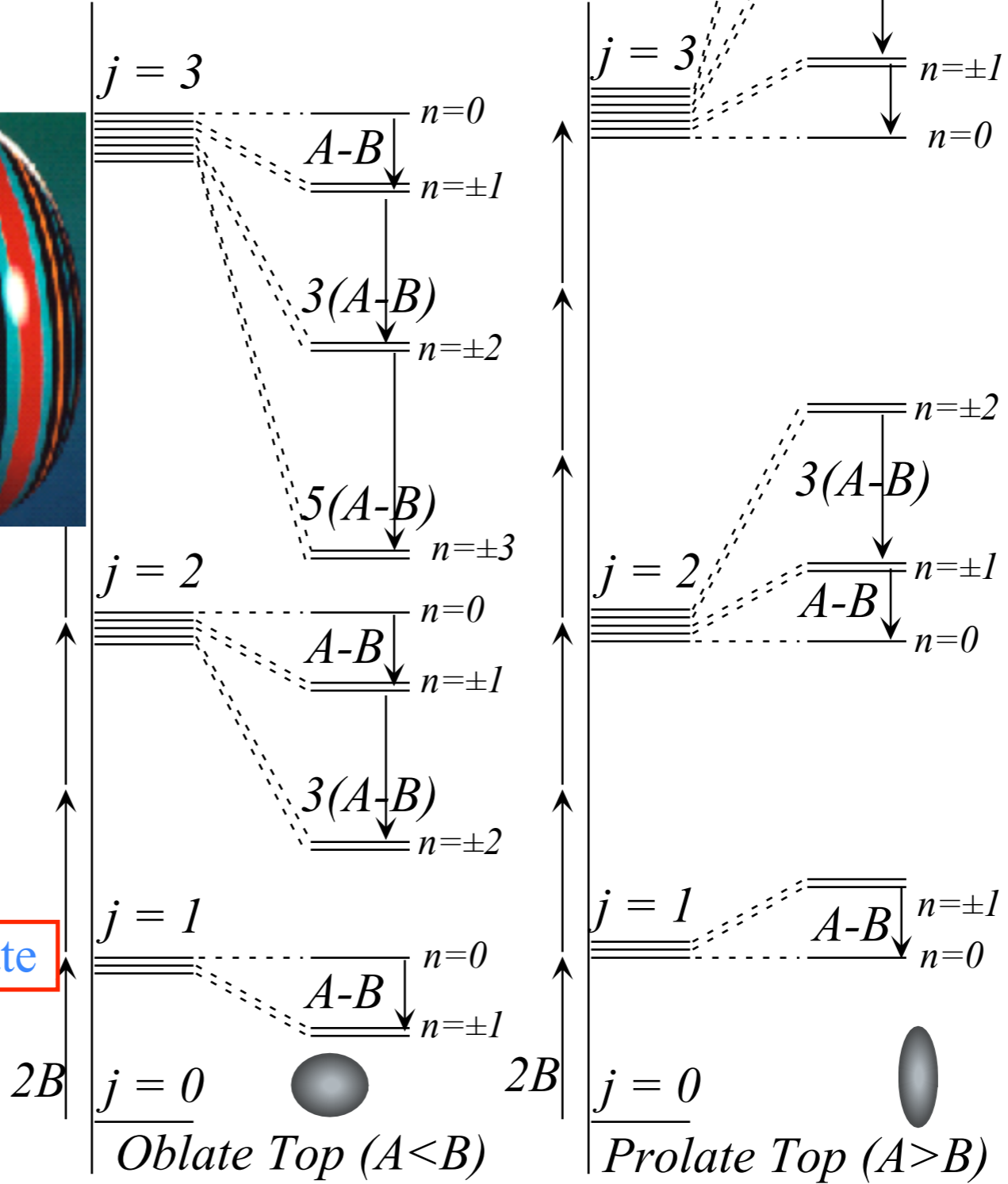
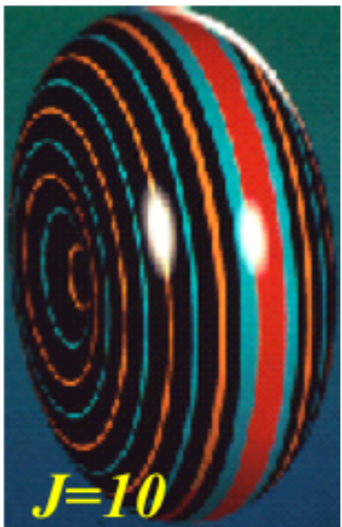
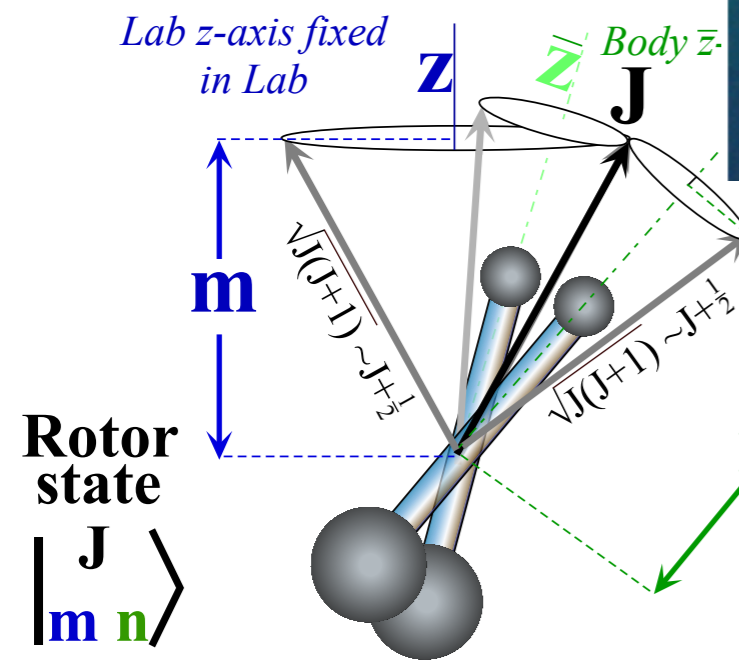

Mock-Mach-Multiplicity is $(2j+1)^2$ for each j



Even $n=0$ levels are $2j+1$ -fold degenerate
If n is non-zero the degeneracy is $4j+2$.

Review :

*Symmetric rigid quantum rotor analysis of $R(2)$ Hamiltonian $\mathbf{H} = B\mathbf{J}_x^2 + B\mathbf{J}_y^2 + C\mathbf{J}_z^2$
Rotational Energy Surfaces (RE or RES) and $R(3) \sim U(2)$ representations*

 *Asymmetric rigid quantum rotor analysis of D_2 Hamiltonian $\mathbf{H} = A\mathbf{J}_x^2 + B\mathbf{J}_y^2 + C\mathbf{J}_z^2$* 

RES and Multipole \mathbf{T}_q^k tensor expansions

Atomic or molecular $R(3)$ ℓ -level or $2\ell+1$ -multiplet splitting

$R(3) \supset D_2$ character analysis of ℓ -level or $2\ell+1$ -multiplet splitting in D_2

Detailed angular momentum operator analysis for $J=1-2$ for D_2 symmetry

Asymmetric rotor levels and RES plots

Octahedral semi-rigid quantum rotor analysis of O_h Hamiltonian $\mathbf{H} = B\mathbf{J} \cdot \mathbf{J} + t_{044}\mathbf{T}^{[4]}$

Spherical rotor levels and RES plots of O_h tensor eigenvalues

$R(3) \subset O(3) \supset O_h \supset O$ character analysis of ℓ -level or $2\ell+1$ -multiplet splitting in O

SF_6 spectral fine structure

CF_4 spectral fine structure

RES of symmetric rotor ($J=10$ Prolate and Oblate)...

... and related RES of asymmetric rotors

Spectra and RES of asymmetric rotors

$$H = A J_x^2 + B J_y^2 + C J_z^2$$

for $J=1, 2, 3, \dots, 10$ discussed below

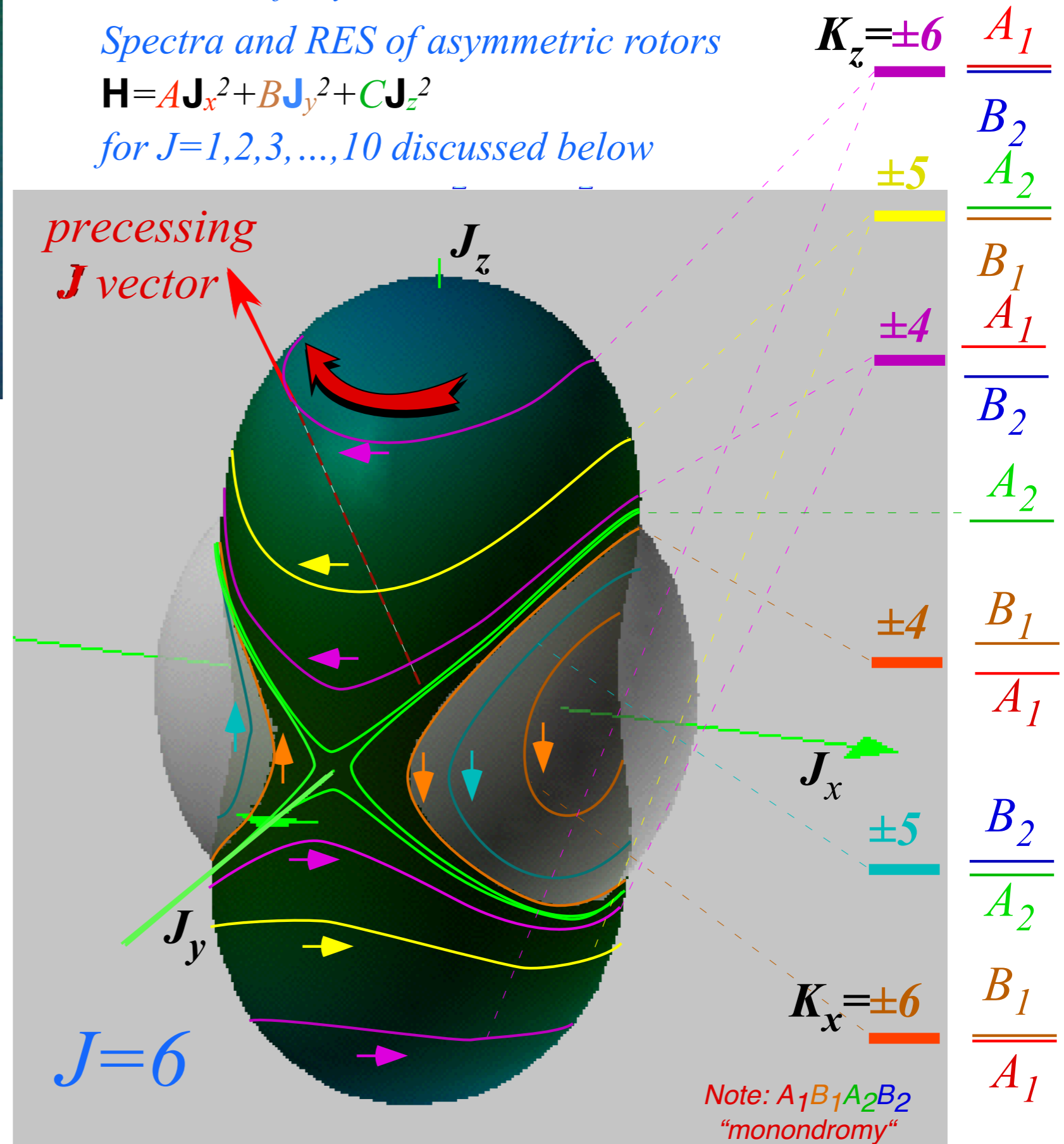
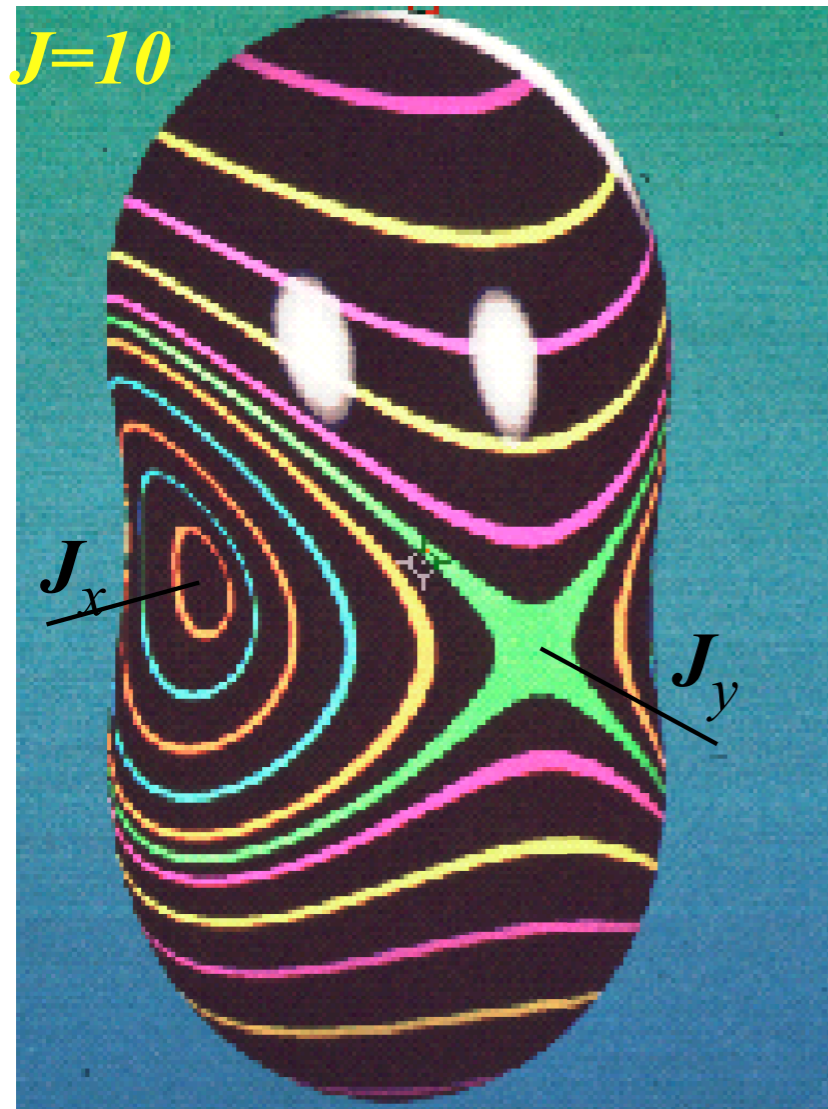
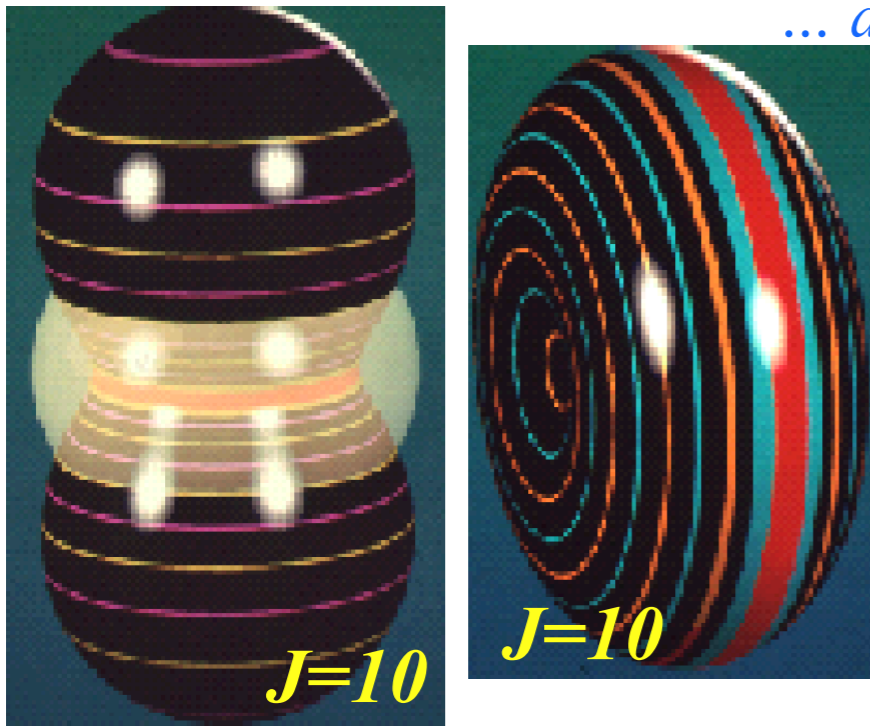

after QTforCA Unit 8. Ch. 25 Fig. 25.4.1

How do you predict $4A_1 \oplus 3A_2 \oplus 3B_1 \oplus 3B_2$? See p.22.

Review :

*Symmetric rigid quantum rotor analysis of $R(2)$ Hamiltonian $\mathbf{H} = B\mathbf{J}_x^2 + B\mathbf{J}_y^2 + C\mathbf{J}_z^2$
Rotational Energy Surfaces (RE or RES) and $R(3) \sim U(2)$ representations*

Asymmetric rigid quantum rotor analysis of D_2 Hamiltonian $\mathbf{H} = A\mathbf{J}_x^2 + B\mathbf{J}_y^2 + C\mathbf{J}_z^2$

RES and Multipole \mathbf{T}_q^k tensor expansions

Atomic or molecular $R(3)$ ℓ -level or $2\ell+1$ -multiplet splitting

$R(3) \supset D_2$ character analysis of ℓ -level or $2\ell+1$ -multiplet splitting in D_2

Detailed angular momentum operator analysis for $J=1-2$ for D_2 symmetry

Asymmetric rotor levels and RES plots

Octahedral semi-rigid quantum rotor analysis of O_h Hamiltonian $\mathbf{H} = B\mathbf{J} \cdot \mathbf{J} + t_{044}\mathbf{T}^{[4]}$

Spherical rotor levels and RES plots of O_h tensor eigenvalues

$R(3) \subset O(3) \supset O_h \supset O$ character analysis of ℓ -level or $2\ell+1$ -multiplet splitting in O

SF_6 spectral fine structure

CF_4 spectral fine structure

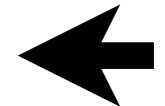
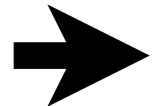

RES and Multipole \mathbf{T}_q^k tensor expansions

Peeking into **BLACK BOX** of matrix diagonalization:

$$\mathbf{H} = \begin{pmatrix} H_{11} & H_{12} & H_{13} & \dots \\ H_{21} & H_{22} & H_{23} & \dots \\ H_{31} & H_{32} & H_{33} & \dots \\ \vdots & \vdots & \vdots & \ddots \end{pmatrix}$$

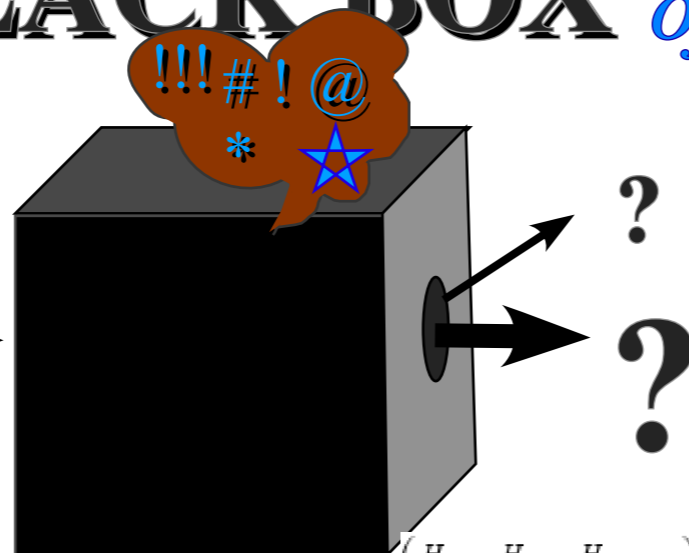

Plotting 2^k -pole expansion of $\begin{pmatrix} H_{11} & H_{12} & H_{13} & \dots \\ H_{21} & H_{22} & H_{23} & \dots \\ H_{31} & H_{32} & H_{33} & \dots \\ \vdots & \vdots & \vdots & \ddots \end{pmatrix}$ into Fano-Racah tensors

scalar+ + vector+ + 2^2 -tensor +... + 2^k -tensor +..

$$\mathbf{H} = a\mathbf{T}_0^0 + b\mathbf{T}_0^1 + c\mathbf{T}_1^1 + \dots + d\mathbf{T}_0^2 + e\mathbf{T}_1^2 + \dots = \sum_q c_q^k \mathbf{T}_q^k$$

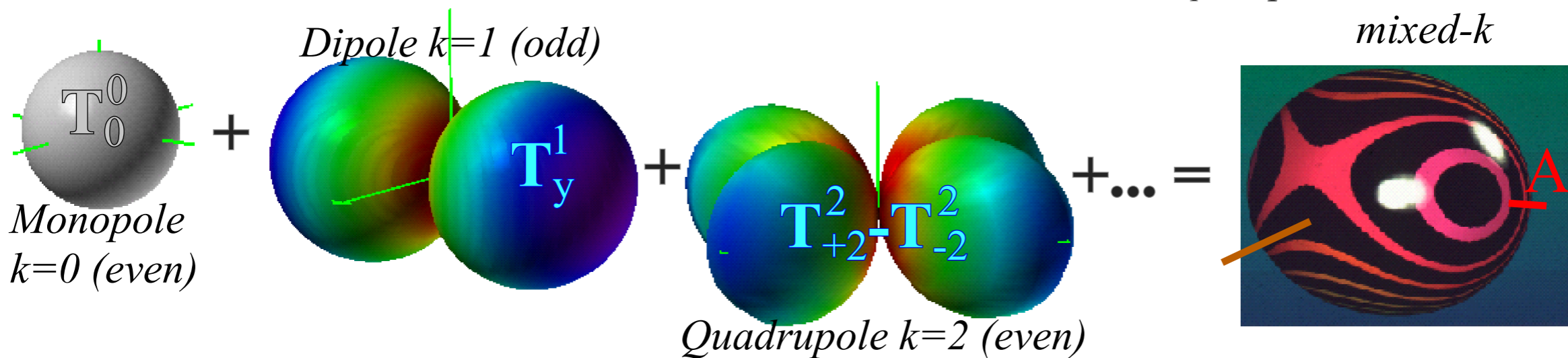

RES and Multipole T_q^k tensor expansions

Momentum 101 $p = m v$
(linear)

$J = L = I \omega$
(rotation)

BANG!

Energy 101 $E = \frac{1}{2} m v^2 = p^2 / 2m$

$E = \frac{1}{2} I \omega^2 = J^2 / 2I$

\$BUCK\$

Simple Rigid Rotor Hamiltonian... (Hamiltonian $H=E$ is energy in terms of momentum)

\$BUCK\$

BANG!

$$H = A J_x^2 + B J_y^2 + C J_z^2 + \dots$$

...and its **multi-pole expansion**...

$\left(\frac{A+B+C}{3} \right) (J_x^2 + J_y^2 + J_z^2)$

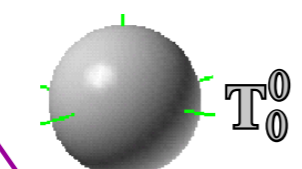

Spherical Top
 $(A=B=C)$
 $H = B J^2$
 $T_0^{(0)} = J^2$

$\left(\frac{2C-A-B}{6} \right) (2J_z^2 - J_x^2 - J_y^2)$

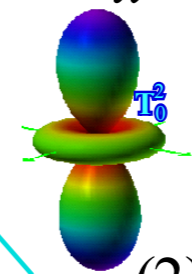

Symmetric Top
 $(A=B \neq C)$
 $H = B J^2 + (C-B)(2/3) T_0^{(2)}$

$\left(\frac{A-B}{2} \right) (J_x^2 - J_y^2)$

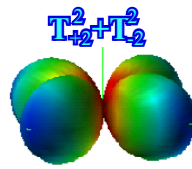

Asymmetric Top
 $(A \neq B \neq C)$
 $\sqrt{\frac{2}{3}} (T_2^{(2)} + T_{-2}^{(2)})$

$$H = B J^2 + (2C-A-B)/3 T_0^{(2)} + (A-B)/\sqrt{6} (T_2^{(2)} + T_{-2}^{(2)})$$

(Derivation in preceding Lecture 25)

RES and Multipole \mathbf{T}_q^k tensor expansions

2^k -pole expansion of an N -by- N matrix \mathbf{H}

2-by-2 case: $\mathbf{H} = \begin{pmatrix} A & B-iC \\ B+iC & D \end{pmatrix} = \frac{A+D}{2} \begin{pmatrix} 1 & 0 \\ 0 & 1 \end{pmatrix} + B \begin{pmatrix} 0 & 1 \\ 1 & 0 \end{pmatrix} + C \begin{pmatrix} 0 & -i \\ i & 0 \end{pmatrix} + \frac{A-D}{2} \begin{pmatrix} 1 & 0 \\ 0 & -1 \end{pmatrix}$

$$= \frac{A+D}{2} \mathbf{1} + B \boldsymbol{\sigma}_x + C \boldsymbol{\sigma}_y + \frac{A-D}{2} \boldsymbol{\sigma}_z$$

$$= \frac{A+D}{2} \mathbf{T}_0^0 + (B-iC) \begin{pmatrix} 0 & 1 \\ 0 & 0 \end{pmatrix} + (B+iC) \begin{pmatrix} 0 & 0 \\ 1 & 0 \end{pmatrix} + \frac{A-D}{2} \mathbf{T}_0^1$$

U(2) generators (spin $J=1/2$)

$$\mathbf{u}_{+1}^1 = \begin{pmatrix} 0 & 1 \\ 0 & 0 \end{pmatrix} \quad \mathbf{u}_0^1 = \begin{pmatrix} 1 & 0 \\ 0 & -1 \end{pmatrix} \frac{1}{\sqrt{2}} \quad \mathbf{u}_{-1}^1 = \begin{pmatrix} 0 & 0 \\ 1 & 0 \end{pmatrix} \quad \text{rank-1 (vector)}$$

$$\mathbf{u}_0^0 = \begin{pmatrix} 1 & 0 \\ 0 & 1 \end{pmatrix} \frac{1}{\sqrt{2}} \quad \text{rank-0 (scalar)}$$

Generalization of U(2) spinor analysis to $U(3) \subset U(4) \subset U(5) \dots$ (Introduced in following Lecture 27)

3-by-3 case: $\mathbf{H} = \begin{pmatrix} H_{11} & H_{12} & H_{13} \\ H_{21} & H_{22} & H_{23} \\ H_{31} & H_{32} & H_{33} \end{pmatrix} = B \mathbf{T}_0^0 + \dots + t_2 \mathbf{T}_2^2 + \dots$

U(3) generators (spin $J=1$)

$$\mathbf{u}_{+2}^2 = \begin{pmatrix} 0 & 0 & 1 \\ 0 & 0 & 0 \\ 0 & 0 & 0 \end{pmatrix} \quad \mathbf{u}_{+1}^2 = \begin{pmatrix} 0 & 1 & 0 \\ 0 & 0 & 1 \\ 0 & 0 & 0 \end{pmatrix} \frac{1}{\sqrt{2}} \quad \mathbf{u}_0^2 = \begin{pmatrix} 1 & 0 & 0 \\ 0 & -2 & 0 \\ 0 & 0 & 1 \end{pmatrix} \frac{1}{\sqrt{6}} \quad \mathbf{u}_{-1}^2 = \begin{pmatrix} 0 & 0 & 0 \\ 1 & 0 & 0 \\ 0 & 1 & 0 \end{pmatrix} \frac{1}{\sqrt{2}} \quad \mathbf{u}_{-2}^2 = \begin{pmatrix} 0 & 0 & 0 \\ 0 & 0 & 0 \\ 1 & 0 & 0 \end{pmatrix} \quad \text{rank-2 (tensor)}$$

$$\mathbf{u}_{+1}^1 = \begin{pmatrix} 0 & 1 & 0 \\ 0 & 0 & 1 \\ 0 & 0 & 0 \end{pmatrix} \frac{1}{\sqrt{2}} \quad \mathbf{u}_0^1 = \begin{pmatrix} 1 & 0 & 0 \\ 0 & 0 & 0 \\ 0 & 0 & -1 \end{pmatrix} \frac{1}{\sqrt{2}} \quad \mathbf{u}_{-1}^1 = \begin{pmatrix} 0 & 0 & 0 \\ 1 & 0 & 0 \\ 0 & 1 & 0 \end{pmatrix} \frac{1}{\sqrt{2}} \quad \text{rank-1 (vector)}$$

$$\mathbf{u}_0^0 = \begin{pmatrix} 1 & 0 & 0 \\ 0 & 1 & 0 \\ 0 & 0 & 1 \end{pmatrix} \frac{1}{\sqrt{3}} \quad \text{rank-0 (scalar)}$$

Mutually commuting diagonal operators

RES and Multipole \mathbf{T}_q^k tensor expansions

J-Phase Paths (Intersection(s) of RE Surface and Energy Sphere)

and

Quantum angular momentum cones

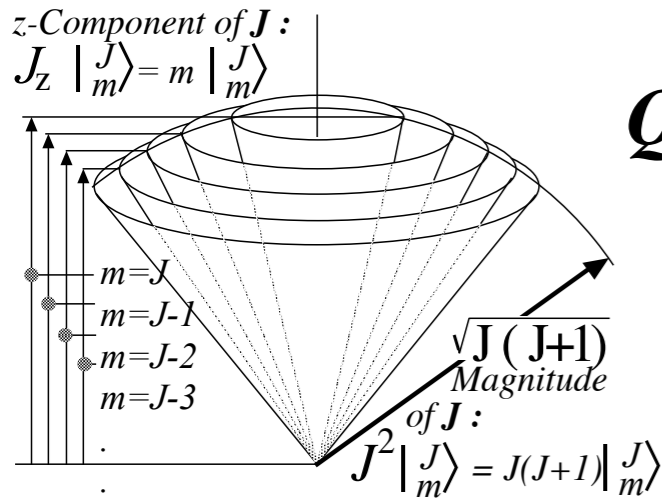

Angular Momentum Cone

J-Phase Path (High E)

Energy Sphere (High E)

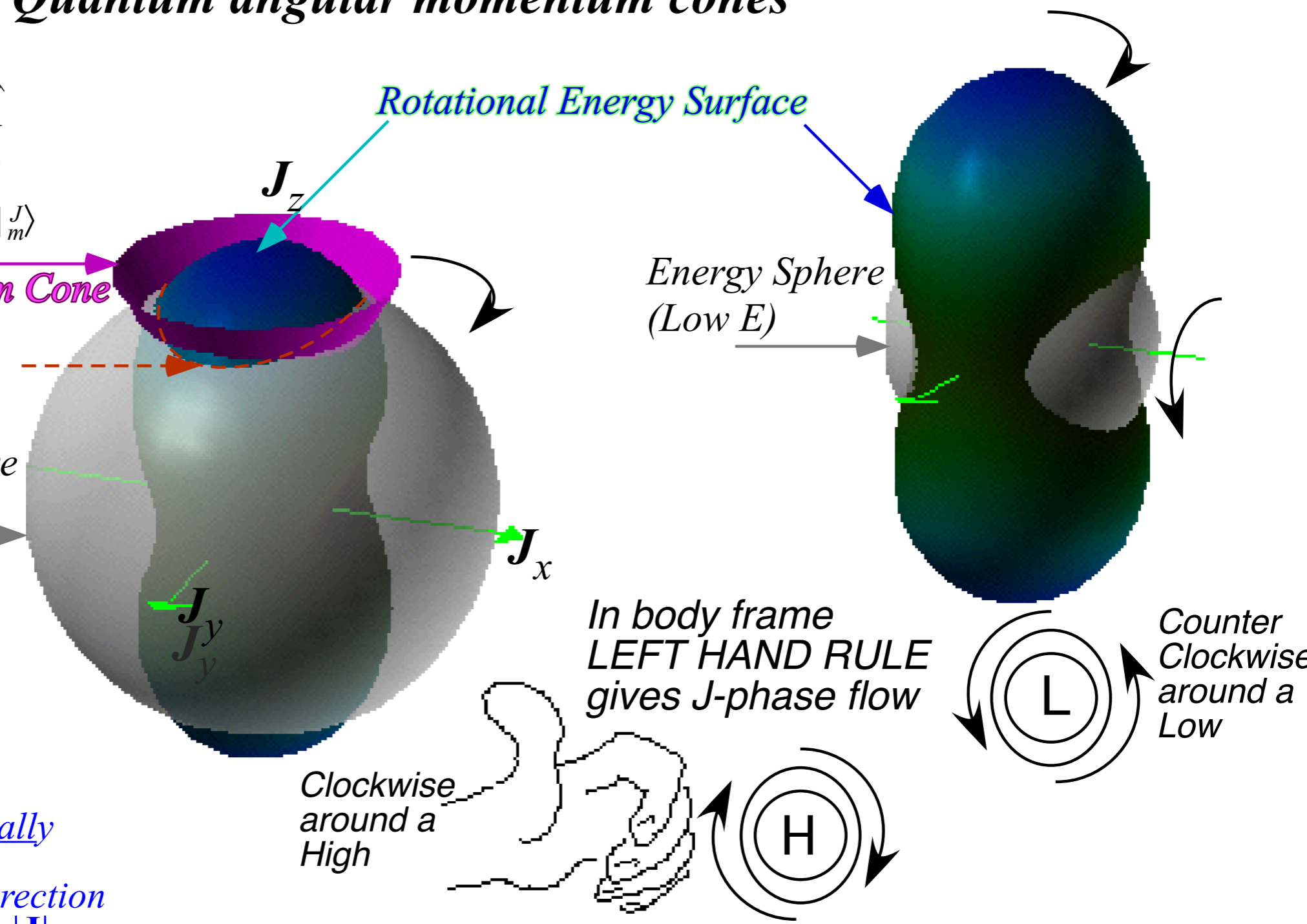

RE Surface
 Energy plotted radially

vs.

BOD frame \mathbf{J} -vector direction
 for fixed magnitude $|\mathbf{J}|$

$$\mathbf{J}^2 \left| \begin{matrix} J \\ K \end{matrix} \right\rangle = J(J+1) \left| \begin{matrix} J \\ K \end{matrix} \right\rangle$$

$$\mathbf{J}_z \left| \begin{matrix} J \\ K \end{matrix} \right\rangle = K \left| \begin{matrix} J \\ K \end{matrix} \right\rangle$$

Interpreted "Literally" is:

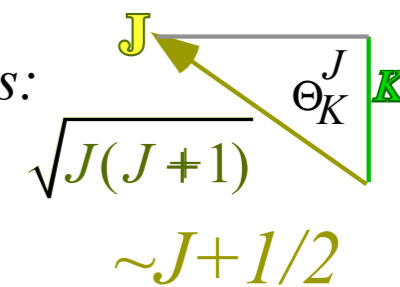

Quantum Angular Cone Uncertainty Angles

$$\cos \Theta_K^J = \frac{K}{\sqrt{J(J+1)}}$$

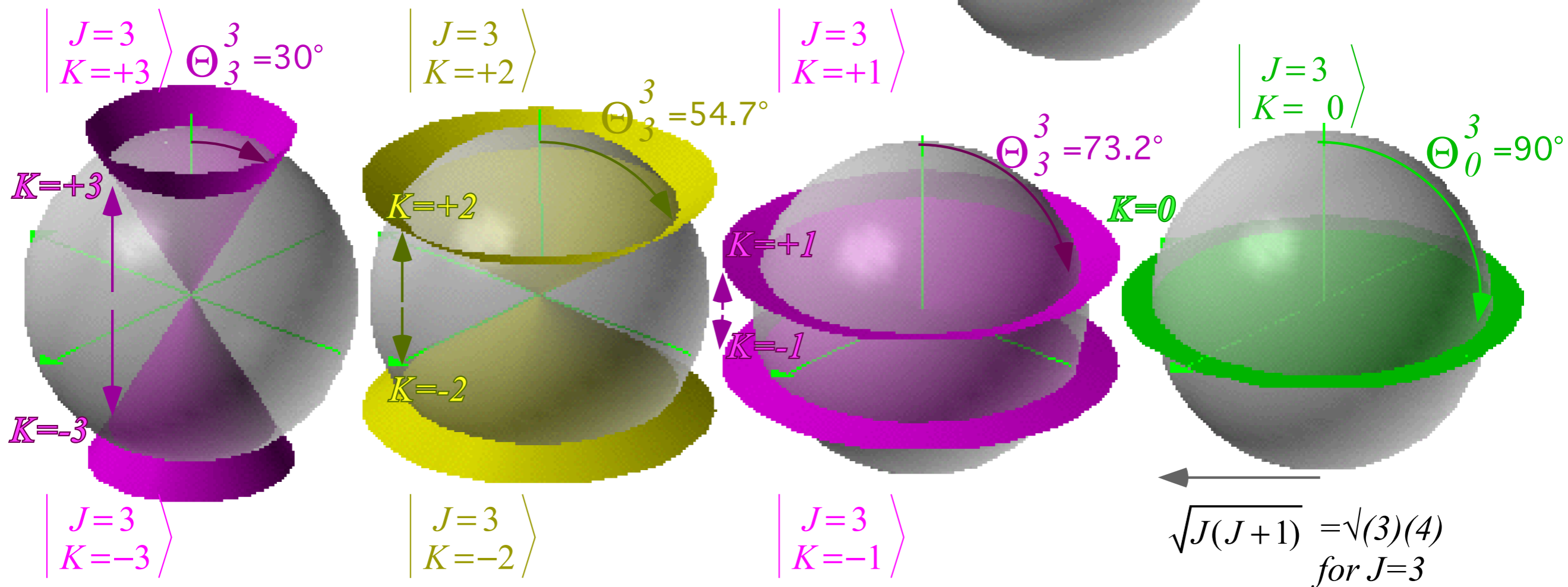
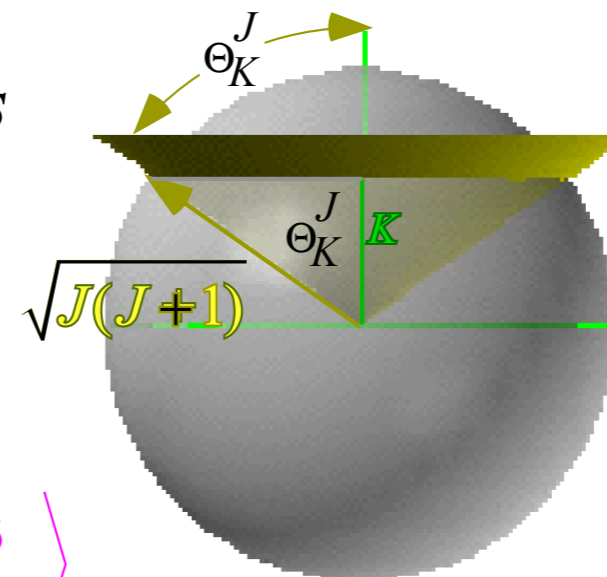

*(S) Semiclassical J-Phase Paths for
(J=3) Prolate Symmetric Rotor*

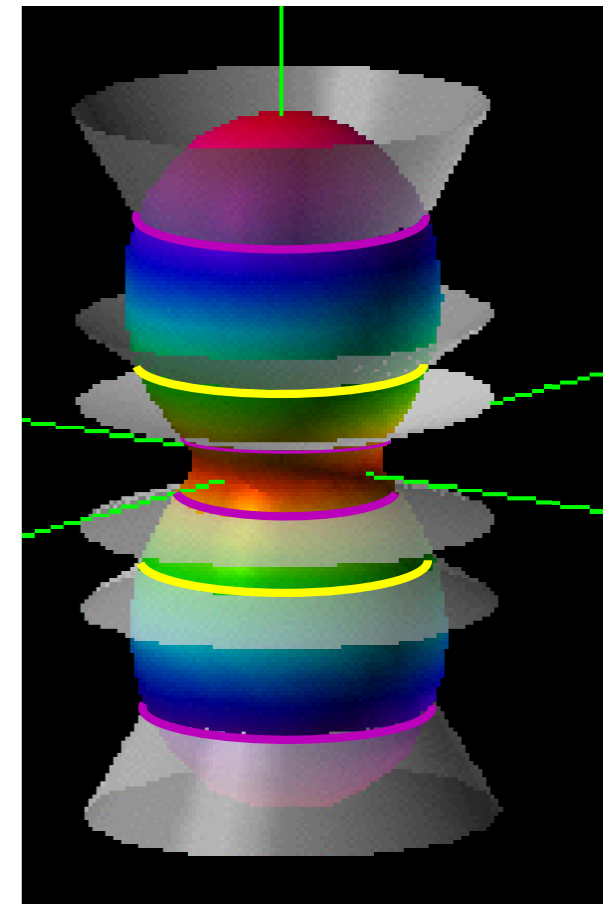
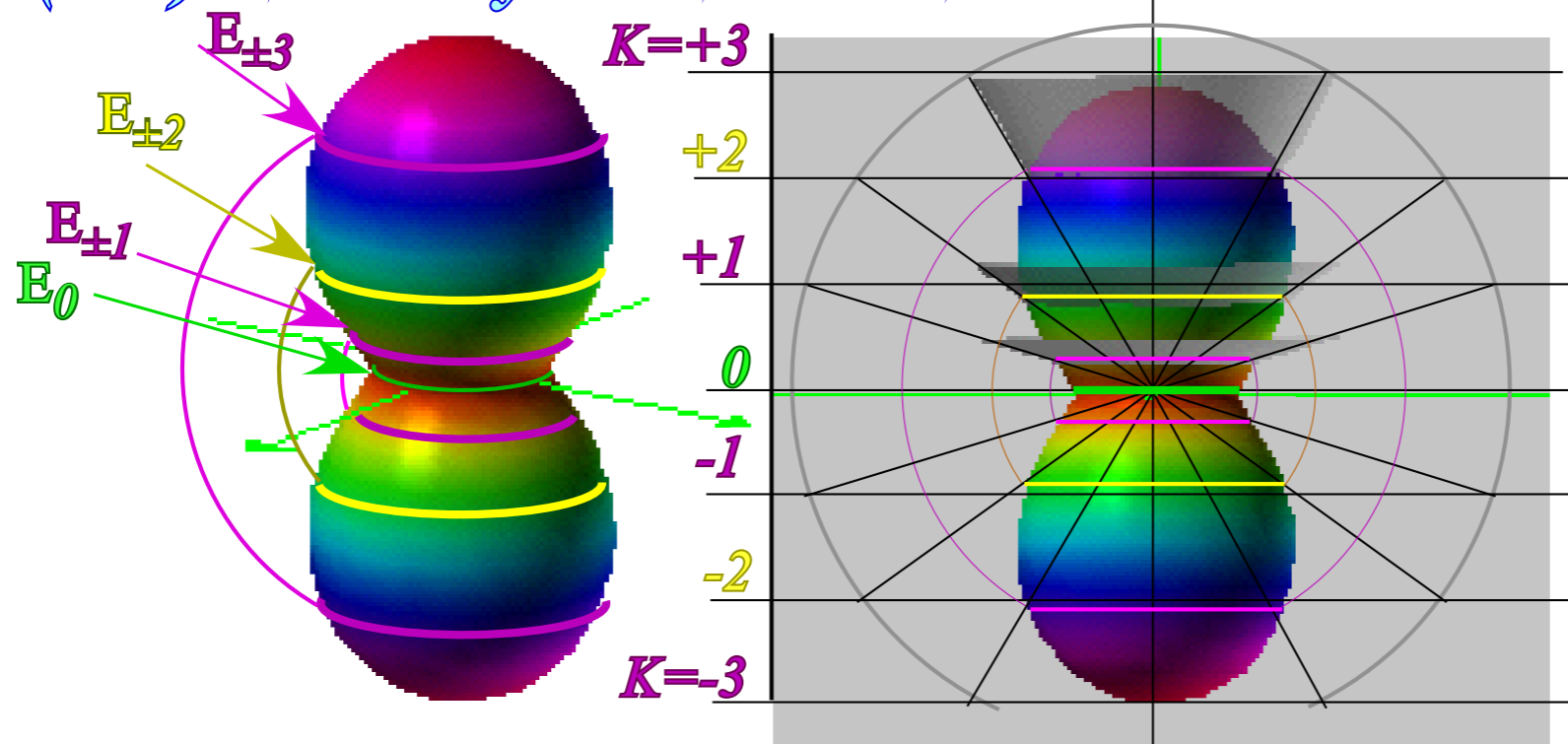

(J=3) Oblate Symmetric Rotor

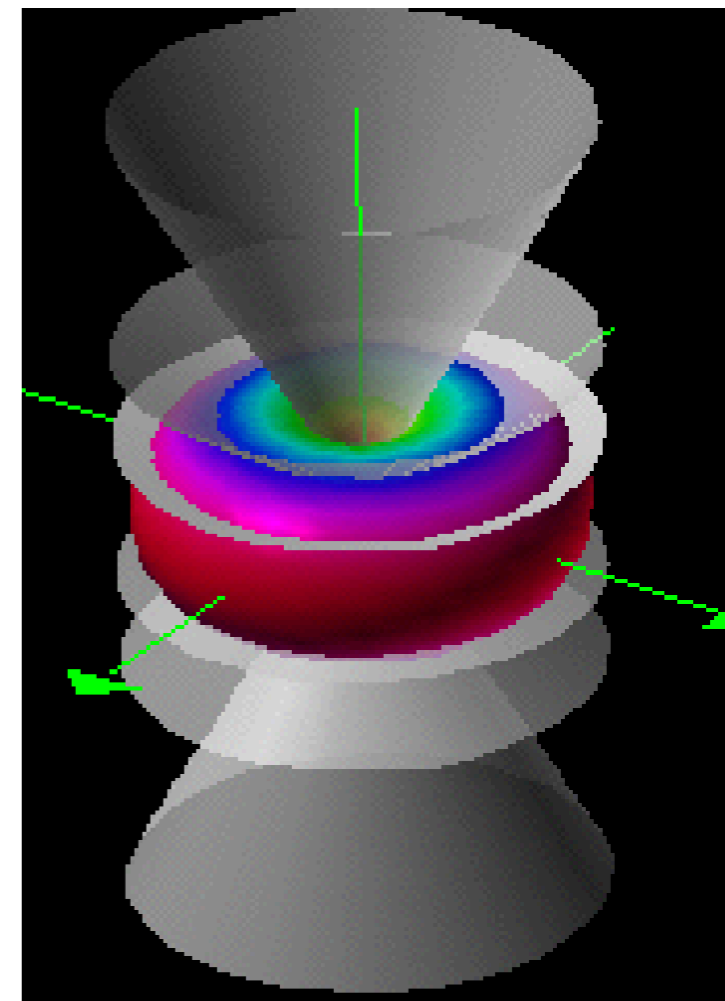
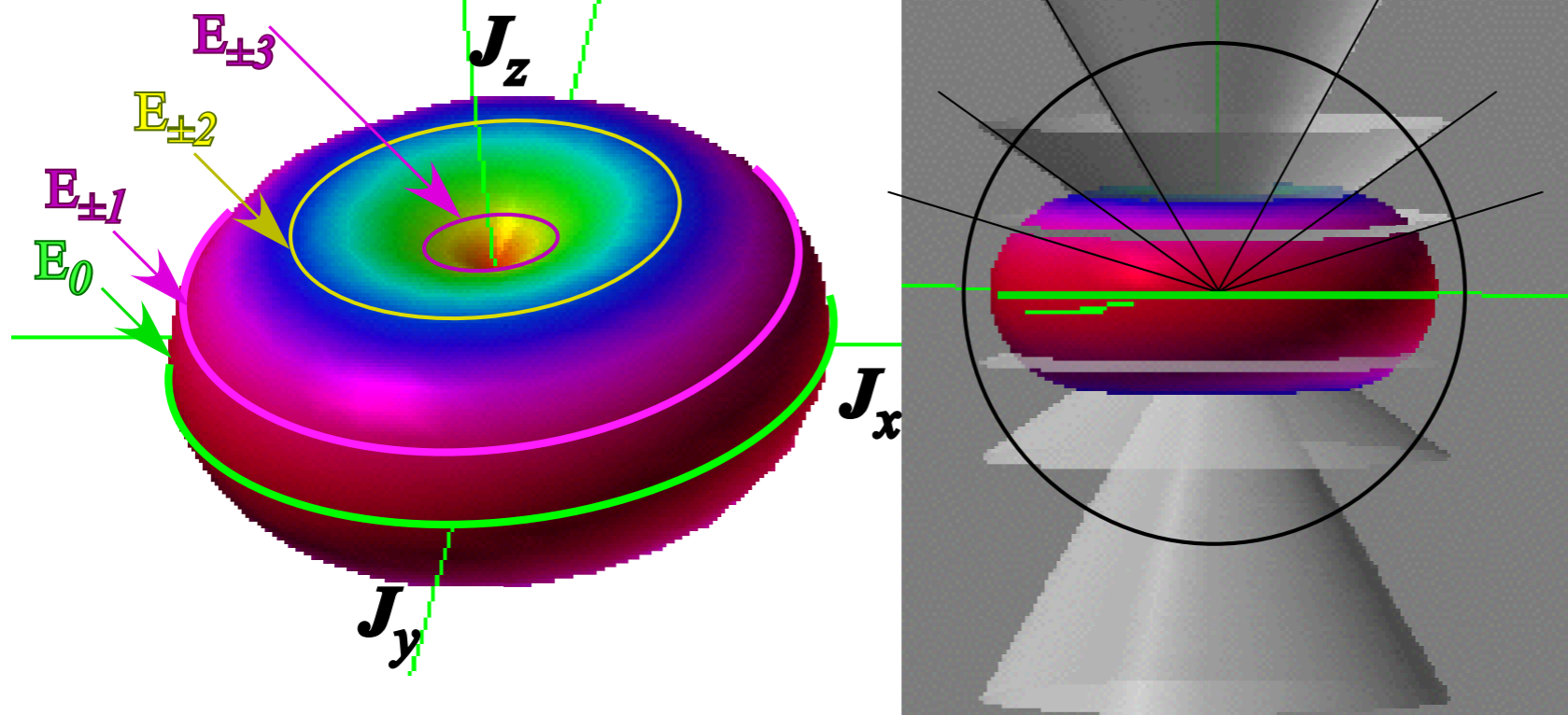

Review :

*Symmetric rigid quantum rotor analysis of $R(2)$ Hamiltonian $\mathbf{H} = B\mathbf{J}_x^2 + B\mathbf{J}_y^2 + C\mathbf{J}_z^2$
Rotational Energy Surfaces (RE or RES) and $R(3) \sim U(2)$ representations*

Asymmetric rigid quantum rotor analysis of D_2 Hamiltonian $\mathbf{H} = A\mathbf{J}_x^2 + B\mathbf{J}_y^2 + C\mathbf{J}_z^2$

RES and Multipole \mathbf{T}_q^k tensor expansions

Atomic or molecular $R(3)$ ℓ -level or $2\ell+1$ -multiplet splitting (Review of D_3)

$R(3) \supset D_2$ character analysis of ℓ -level or $2\ell+1$ -multiplet splitting in D_2

Detailed angular momentum operator analysis for $J=1-2$ for D_2 symmetry

Asymmetric rotor levels and RES plots for high- J

Octahedral semi-rigid quantum rotor analysis of O_h Hamiltonian $\mathbf{H} = B\mathbf{J} \cdot \mathbf{J} + t_{044}\mathbf{T}^{[4]}$

Spherical rotor levels and RES plots of O_h tensor eigenvalues

$R(3) \subset O(3) \supset O_h \supset O$ character analysis of ℓ -level or $2\ell+1$ -multiplet splitting in O

SF_6 spectral fine structure

CF_4 spectral fine structure

Atomic ℓ -level or $2\ell+1$ -multiplet splitting in D_3

Recall p.58 of Lect.15 on D_3 level splitting

Example: ($\ell=4$)

$$f^{(b)} = \frac{1}{|D_3|} \sum_{\text{classes } \kappa_k \in D_3} \kappa_k \chi_k^{(b)*} \chi_k^{(\ell)}$$

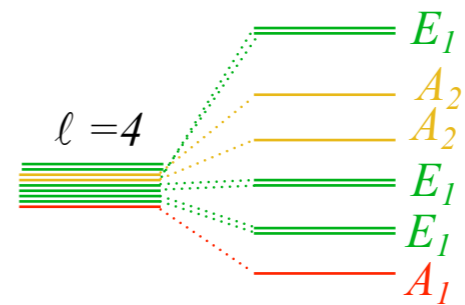

- $\ell=0$, s -singlet
 $2\ell+1=1$
- $\ell=1$, p -triplet
 $2\ell+1=3$
- $\ell=2$, d -quintet
 $2\ell+1=5$
- $\ell=3$, f -septet
 $2\ell+1=7$
- $\ell=4$, g -nonet
 $2\ell+1=9$
- $\ell=5$, h -11-let
 $2\ell+1=11$
- ...

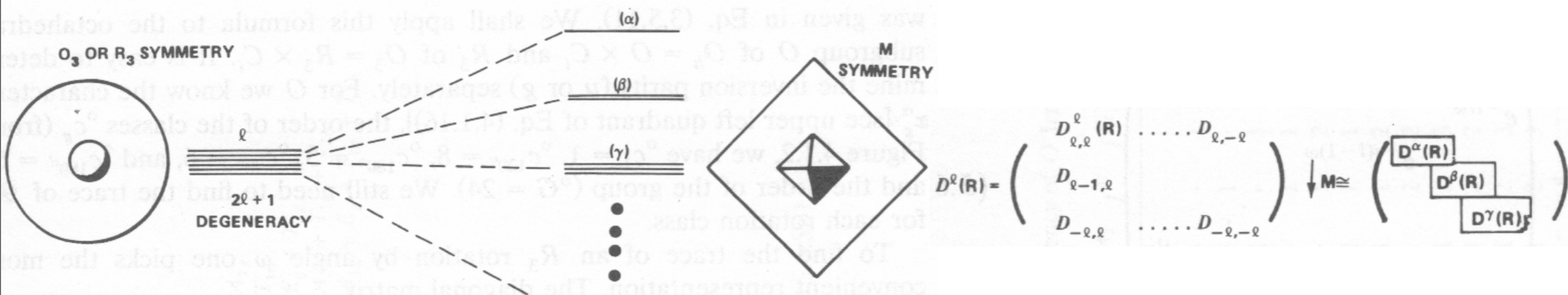

$U(2)$ characters from Lecture 12.6 p.134 :

$\chi^\ell(\Theta)$	$\Theta=0$	$\frac{2\pi}{3}$	π
$\ell=0$	1	1	1
1	3	0	-1
2	5	-1	1
3	7	1	-1
4	9	0	1
5	11	-1	-1
6	13	1	1
7	15	0	-1

$$\chi^\ell\left(\frac{2\pi}{n}\right) = \frac{\sin\frac{(2\ell+1)\pi}{n}}{\sin\frac{\pi}{n}}$$

$$\chi^\ell(\Theta) = \frac{\sin\left(\ell + \frac{1}{2}\right)\Theta}{\sin\frac{\Theta}{2}}$$

$R(3)$ character where: $2\ell+1$ is ℓ -orbital dimension

$f^{(\alpha)}(\ell)$	f^{A_1}	f^{A_2}	f^{E_1}	
$\ell=0$	1	.	.	$1A_1$
1	.	1	1	$0A_1 \oplus A_2 \oplus E_1$
2	1	.	2	$1A_1 \oplus 2E_1$

...and D_3 character table from p. 24:

$(\mathbf{g}) =$	$\{1\}$	$\{r^1, r^2\}$	$\{i_1, i_2, i_3\}$
$\chi^{A_1}(\mathbf{g}) =$	1	1	1
$\chi^{A_2}(\mathbf{g}) =$	1	1	-1
$\chi^{E_1}(\mathbf{g}) =$	2	-1	0

$\chi^{A_1}(\mathbf{g}) =$	5	-1	1	trial&error??
$0\chi^{A_2}(\mathbf{g}) =$	1	1	1	
$0\chi^{A_2}(\mathbf{g}) =$	0	0	0	
$2\chi^{E_1}(\mathbf{g}) =$	4	-2	0	

Review :

*Symmetric rigid quantum rotor analysis of $R(2)$ Hamiltonian $\mathbf{H} = B\mathbf{J}_x^2 + B\mathbf{J}_y^2 + C\mathbf{J}_z^2$
Rotational Energy Surfaces (RE or RES) and $R(3) \sim U(2)$ representations*

*Asymmetric rigid quantum rotor analysis of D_2 Hamiltonian $\mathbf{H} = A\mathbf{J}_x^2 + B\mathbf{J}_y^2 + C\mathbf{J}_z^2$
RES and Multipole \mathbf{T}_q^k tensor expansions*

Atomic or molecular $R(3)$ ℓ -level or $2\ell+1$ -multiplet splitting (Review of D_3)

$R(3) \supset D_2$ character analysis of ℓ -level or $2\ell+1$ -multiplet splitting in D_2

Detailed angular momentum operator analysis for $J=1-2$ for D_2 symmetry

Asymmetric rotor levels and RES plots for high- J

Octahedral semi-rigid quantum rotor analysis of O_h Hamiltonian $\mathbf{H} = B\mathbf{J} \cdot \mathbf{J} + t_{044}\mathbf{T}^{[4]}$

Spherical rotor levels and RES plots of O_h tensor eigenvalues

$R(3) \subset O(3) \supset O_h \supset O$ character analysis of ℓ -level or $2\ell+1$ -multiplet splitting in O

SF_6 spectral fine structure

CF_4 spectral fine structure

Atomic ℓ -level or $2\ell+1$ -multiplet splitting in D_2

Here we apply that to D_2 level splitting

Example: ($\ell=1$) $f^{(b)} = \frac{1}{|D_2|} \sum_{\kappa_k \in D_2} \kappa_k \chi_k^{(b)*} \chi_k^{(\ell)} = \frac{1}{4} \sum_{g \in D_2} \chi_k^{(b)*} \chi_k^{(\ell)}$

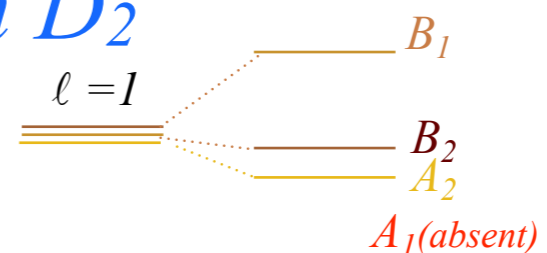

- $\ell=0$, s-singlet $2\ell+1=1$
- $\ell=1$, p-triplet $2\ell+1=3$
- $\ell=2$, d-quintet $2\ell+1=5$
- $\ell=3$, f-septet $2\ell+1=7$
- $\ell=4$, g-nonet $2\ell+1=9$
- $\ell=5$, h-(11)-let $2\ell+1=11$
- ...

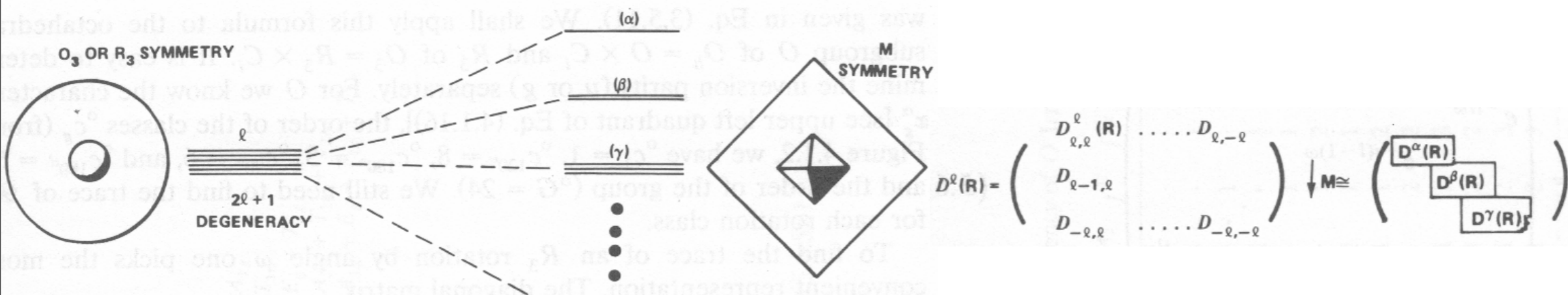

$U(2)$ characters from Lecture 12.6 p.134 :

$\chi^\ell(\Theta)$	$\Theta=0$	$R_x\pi$	$R_y\pi$	$R_z\pi$
$\ell=0$	1	1	1	1
1	3	-1	-1	-1
2	5	1	1	1
3	7	-1	-1	-1
4	9	1	1	1
5	11	-1	-1	-1
6	13	1	1	1
7	15	-1	-1	-1
8	17	1	1	1

$$\chi^\ell\left(\frac{2\pi}{n}\right) = \frac{\sin\frac{(2\ell+1)\pi}{n}}{\sin\frac{\pi}{n}}$$

$$\chi^\ell(\Theta) = \frac{\sin\left(\ell + \frac{1}{2}\right)\Theta}{\sin\frac{\Theta}{2}}$$

$R(3)$ character where: $2\ell+1$ is ℓ -orbital dimension

Atomic ℓ -level or $2\ell+1$ -multiplet splitting in D_2

Here we apply that to D_2 level splitting

Example: ($\ell=1$) $f^{(b)} = \frac{1}{|D_2|} \sum_{\kappa_k \in D_2} \kappa_k \chi_k^{(b)*} \chi_k^{(\ell)} = \frac{1}{4} \sum_{g \in D_2} \chi_k^{(b)*} \chi_k^{(\ell)}$

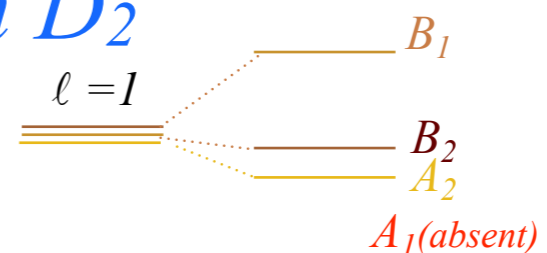

- $\ell=0, s\text{-singlet}$
 $2\ell+1=1$
- $\ell=1, p\text{-triplet}$
 $2\ell+1=3$
- $\ell=2, d\text{-quintet}$
 $2\ell+1=5$
- $\ell=3, f\text{-septet}$
 $2\ell+1=7$
- $\ell=4, g\text{-nonet}$
 $2\ell+1=9$
- $\ell=5, h\text{-}(11)\text{-let}$
 $2\ell+1=11$
- ...

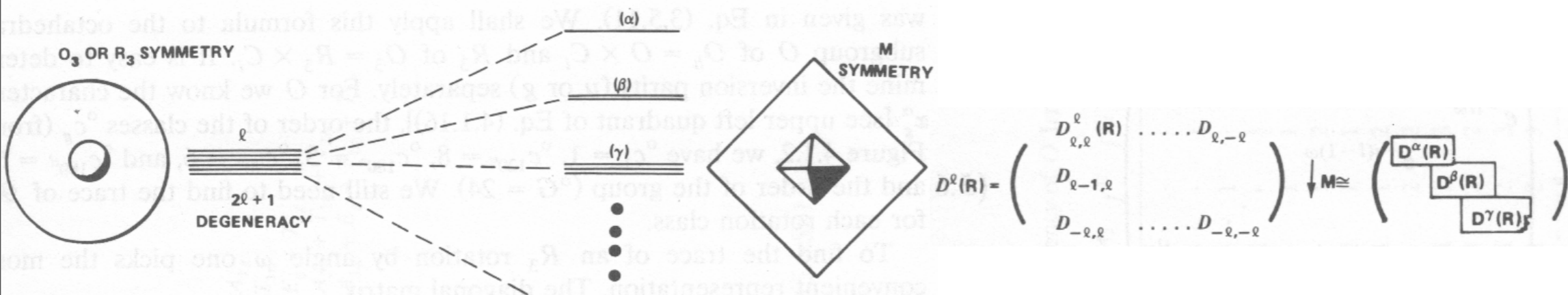

$U(2)$ characters
from Lecture 12.6 p.134 :

$\chi^{\ell}(\Theta)$	$\Theta=0$	$R_x \pi$	$R_y \pi$	$R_z \pi$
$\ell=0$	1	1	1	1
1	3	-1	-1	-1
2	5	1	1	1
3	7	-1	-1	-1
4	9	1	1	1
5	11	-1	-1	-1
6	13	1	1	1
7	15	-1	-1	-1
8	17	1	1	1

$$\chi^{\ell}\left(\frac{2\pi}{n}\right) = \frac{\sin\left(\frac{(2\ell+1)\pi}{n}\right)}{\sin\left(\frac{\pi}{n}\right)}$$

$$\chi^{\ell}(\Theta) = \frac{\sin\left(\left(\ell + \frac{1}{2}\right)\Theta\right)}{\sin\left(\frac{\Theta}{2}\right)}$$

...and Lect.13 p.79

D_2 characters:

D_2	1	R_x	R_y	R_z
A_1	1	1	1	1
A_2	1	-1	1	-1
B_1	1	1	-1	-1
B_2	1	-1	-1	1

$R(3)$ character
where: $2\ell+1$
is ℓ -orbital dimension

Atomic ℓ -level or $2\ell+1$ -multiplet splitting in D_2

Here we apply that to D_2 level splitting

Example: ($\ell=1$) $f^{(b)} = \frac{1}{|D_2|} \sum_{\kappa_k \in D_2} \chi_{\kappa_k}^{(b)*} \chi_{\kappa_k}^{(\ell)} = \frac{1}{4} \sum_{g \in D_2} \chi_g^{(b)*} \chi_g^{(\ell)}$

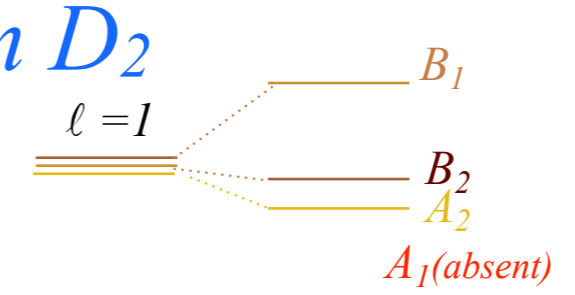

- $\ell=0, s$ -singlet $2\ell+1=1$
- $\ell=1, p$ -triplet $2\ell+1=3$
- $\ell=2, d$ -quintet $2\ell+1=5$
- $\ell=3, f$ -septet $2\ell+1=7$
- $\ell=4, g$ -nonet $2\ell+1=9$
- $\ell=5, h$ -11-plet $2\ell+1=11$
- ...

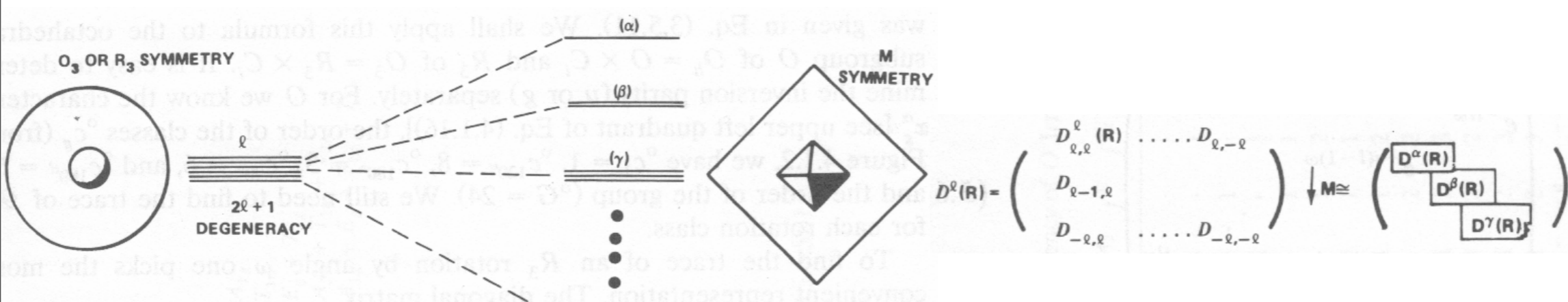

$U(2)$ characters from Lecture 12.6 p.134 :

$\chi^\ell(\Theta)$	$\Theta=0$	$R_x \pi$	$R_y \pi$	$R_z \pi$
$\ell=0$	1	1	1	1
1	3	-1	-1	-1
2	5	1	1	1
3	7	-1	-1	-1
4	9	1	1	1
5	11	-1	-1	-1
6	13	1	1	1
7	15	-1	-1	-1
8	17	1	1	1

$$\chi^\ell\left(\frac{2\pi}{n}\right) = \frac{\sin\left(\frac{(2\ell+1)\pi}{n}\right)}{\sin\left(\frac{\pi}{n}\right)}$$

$$\chi^\ell(\Theta) = \frac{\sin\left(\left(\ell + \frac{1}{2}\right)\Theta\right)}{\sin\left(\frac{\Theta}{2}\right)}$$

...and Lect.13 p.79

D_2 characters:

D_2	1	R_x	R_y	R_z
A_1	1	1	1	1
A_2	1	-1	1	-1
B_1	1	1	-1	-1
B_2	1	-1	-1	1

$R(3)$ character

where: $2\ell+1$

is ℓ -orbital dimension

$f^{(\alpha)}(\ell)$	f^{A_1}	f^{A_2}	f^{B_1}	f^{B_2}
$\ell=0$	1	.	.	.
1	.	1	1	1

$1A_1$
 $0A_1 \oplus A_2 \oplus B_1 \oplus B_2$

$0\chi^{A_1}(\mathbf{g}) =$	3	-1	-1	-1
$1\chi^{A_2}(\mathbf{g}) =$	1	1	1	1
$1\chi^{B_1}(\mathbf{g}) =$	1	-1	1	-1
$1\chi^{B_2}(\mathbf{g}) =$	1	1	-1	-1
	1	-1	-1	1

trial&error??

Atomic ℓ -level or $2\ell+1$ -multiplet splitting in D_2

Here we apply that to D_2 level splitting

Example: ($\ell=1$) $f^{(b)} = \frac{1}{|D_2|} \sum_{\kappa_k \in D_2} \kappa_k \chi_k^{(b)*} \chi_k^{(\ell)} = \frac{1}{4} \sum_{g \in D_2} \chi_k^{(b)*} \chi_k^{(\ell)}$
 and: ($\ell=2$)

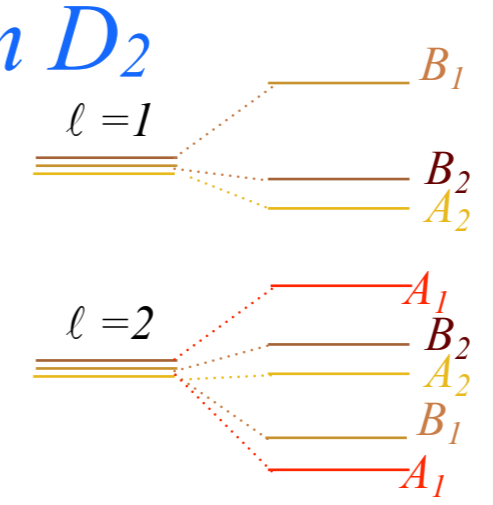

- $\ell=0, s$ -singlet $2\ell+1=1$
- $\ell=1, p$ -triplet $2\ell+1=3$
- $\ell=2, d$ -quintet $2\ell+1=5$
- $\ell=3, f$ -septet $2\ell+1=7$
- $\ell=4, g$ -nonet $2\ell+1=9$
- $\ell=5, h$ -(11)-let $2\ell+1=11$
- ...

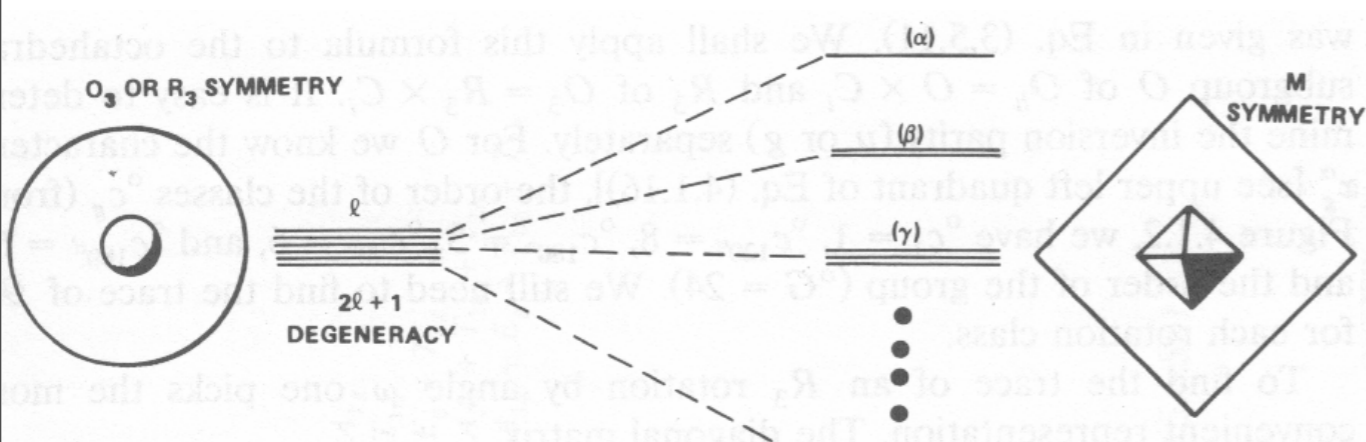

$$D^\ell(\mathbf{R}) = \begin{pmatrix} D_{\ell,\ell} & \dots & D_{\ell,-\ell} \\ D_{\ell-1,\ell} & & \\ \vdots & & \\ D_{-\ell,\ell} & \dots & D_{-\ell,-\ell} \end{pmatrix} \xrightarrow{M \cong} \begin{pmatrix} D^\alpha(\mathbf{R}) \\ D^\beta(\mathbf{R}) \\ D^\gamma(\mathbf{R}) \end{pmatrix}$$

$U(2)$ characters from Lecture 12.6 p.134 :

$\chi^\ell(\Theta)$	$\Theta=0$	$\mathbf{R}_x\pi$	$\mathbf{R}_y\pi$	$\mathbf{R}_z\pi$
$\ell=0$	1	1	1	1
1	3	-1	-1	-1
2	5	1	1	1
3	7	-1	-1	-1
4	9	1	1	1
5	11	-1	-1	-1
6	13	1	1	1
7	15	-1	-1	-1
8	17	1	1	1

$$\chi^\ell\left(\frac{2\pi}{n}\right) = \frac{\sin\left(\frac{(2\ell+1)\pi}{n}\right)}{\sin\left(\frac{\pi}{n}\right)}$$

$$\chi^\ell(\Theta) = \frac{\sin\left(\left(\ell + \frac{1}{2}\right)\Theta\right)}{\sin\left(\frac{\Theta}{2}\right)}$$

...and Lect.13 p.79

D_2 characters:

D_2	1	\mathbf{R}_x	\mathbf{R}_y	\mathbf{R}_z
A_1	1	1	1	1
A_2	1	-1	1	-1
B_1	1	1	-1	-1
B_2	1	-1	-1	1

$R(3)$ character

where: $2\ell+1$

is ℓ -orbital dimension

$f^{(\alpha)}(\ell)$	f^{A_1}	f^{A_2}	f^{B_1}	f^{B_2}	
$\ell=0$	1	.	.	.	$1A_1$
1	.	1	1	1	$0A_1 \oplus A_2 \oplus B_1 \oplus B_2$
2	2	1	1	1	$2A_1 \oplus A_2 \oplus B_1 \oplus B_2$

$2\chi^{A_1}(\mathbf{g}) =$	5	1	1	1
$1\chi^{A_2}(\mathbf{g}) =$	2	2	2	2
$1\chi^{B_1}(\mathbf{g}) =$	1	-1	1	-1
$1\chi^{B_2}(\mathbf{g}) =$	1	1	-1	-1
	1	-1	-1	1

trial&error??

Atomic ℓ -level or $2\ell+1$ -multiplet splitting in D_2

Here we apply that to D_2 level splitting

Example: ($\ell=1$) $f^{(b)} = \frac{1}{|D_2|} \sum_{\kappa_k \in D_2} \chi_{\kappa_k}^{(b)*} \chi_{\kappa_k}^{(\ell)} = \frac{1}{4} \sum_{g \in D_2} \chi_{\kappa_k}^{(b)*} \chi_{\kappa_k}^{(\ell)}$
 and: ($\ell=2$)

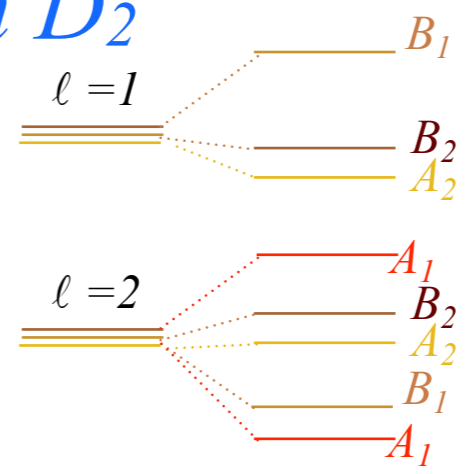

- $\ell=0, s$ -singlet
 $2\ell+1=1$
- $\ell=1, p$ -triplet
 $2\ell+1=3$
- $\ell=2, d$ -quintet
 $2\ell+1=5$
- $\ell=3, f$ -septet
 $2\ell+1=7$
- $\ell=4, g$ -nonet
 $2\ell+1=9$
- $\ell=5, h$ -(11)-let
 $2\ell+1=11$
- ...

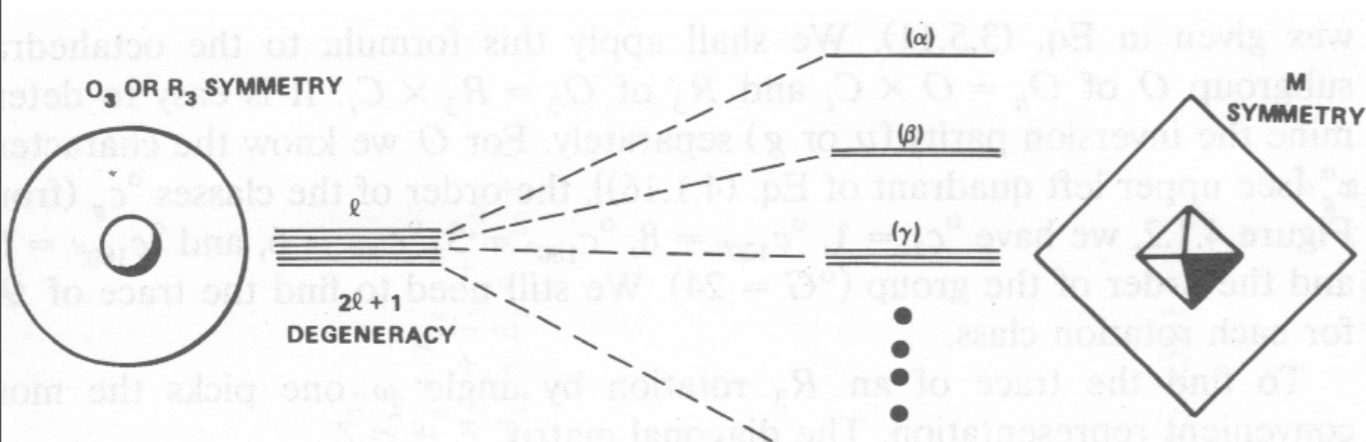

$$D^{\ell}(\mathbf{R}) = \begin{pmatrix} D_{\ell,\ell} & \dots & D_{\ell,-\ell} \\ D_{\ell-1,\ell} & & \\ \vdots & & \\ D_{-\ell,\ell} & \dots & D_{-\ell,-\ell} \end{pmatrix} \xrightarrow{M \cong} \begin{pmatrix} D^{\alpha}(\mathbf{R}) \\ D^{\beta}(\mathbf{R}) \\ D^{\gamma}(\mathbf{R}) \end{pmatrix}$$

$U(2)$ characters
from Lecture 12.6 p.134 :

$\chi^{\ell}(\Theta)$	$\Theta=0$	$\mathbf{R}_x\pi$	$\mathbf{R}_y\pi$	$\mathbf{R}_z\pi$
$\ell=0$	1	1	1	1
1	3	-1	-1	-1
2	5	1	1	1
3	7	-1	-1	-1
4	9	1	1	1
5	11	-1	-1	-1
6	13	1	1	1
7	15	-1	-1	-1
8	17	1	1	1

$$\chi^{\ell}\left(\frac{2\pi}{n}\right) = \frac{\sin\frac{(2\ell+1)\pi}{n}}{\sin\frac{\pi}{n}}$$

$$\chi^{\ell}(\Theta) = \frac{\sin(\ell + \frac{1}{2})\Theta}{\sin\frac{\Theta}{2}}$$

...and Lect.13 p.79

D_2 characters:

D_2	1	\mathbf{R}_x	\mathbf{R}_y	\mathbf{R}_z
A_1	1	1	1	1
A_2	1	-1	1	-1
B_1	1	1	-1	-1
B_2	1	-1	-1	1

$R(3)$ character

where: $2\ell+1$

is ℓ -orbital dimension

$f^{(\alpha)}(\ell)$	f^{A_1}	f^{A_2}	f^{B_1}	f^{B_2}	
$\ell=0$	1	.	.	.	$1A_1$
1	.	1	1	1	$0A_1 \oplus A_2 \oplus B_1 \oplus B_2$
2	2	1	1	1	$2A_1 \oplus A_2 \oplus B_1 \oplus B_2$

f -formula better than trial&error

$$\frac{1}{4} \begin{vmatrix} 1 & 1 & 1 & 1 \\ 5 & 1 & 1 & 1 \end{vmatrix} = \frac{5+1+1+1}{4} = 2$$

$$\frac{1}{4} \begin{vmatrix} 1 & -1 & 1 & -1 \\ 5 & 1 & 1 & 1 \end{vmatrix} = \frac{5-1+1-1}{4} = 1$$

Atomic ℓ -level or $2\ell+1$ -multiplet splitting in D_2

Here we apply that to D_2 level splitting

Example: ($\ell=1$) $f^{(b)} = \frac{1}{|D_2|} \sum_{\kappa_k \in D_2} \kappa_k \chi_k^{(b)*} \chi_k^{(\ell)} = \frac{1}{4} \sum_{g \in D_2} \chi_k^{(b)*} \chi_k^{(\ell)}$
 and: ($\ell=2$)
 and: ($\ell=3$)

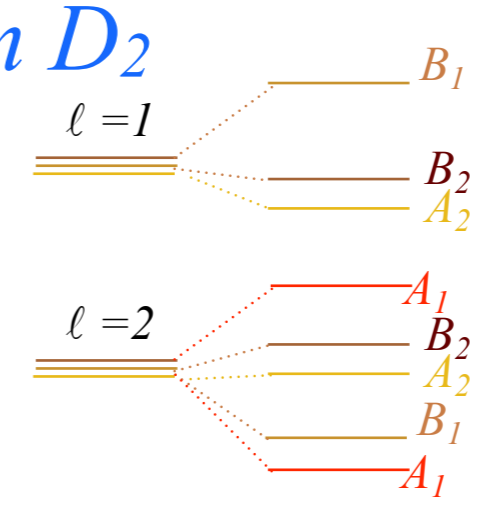

- $\ell=0, s$ -singlet
 $2\ell+1=1$
- $\ell=1, p$ -triplet
 $2\ell+1=3$
- $\ell=2, d$ -quintet
 $2\ell+1=5$
- $\ell=3, f$ -septet
 $2\ell+1=7$
- $\ell=4, g$ -nonet
 $2\ell+1=9$
- $\ell=5, h$ -(11)-let
 $2\ell+1=11$
- ...

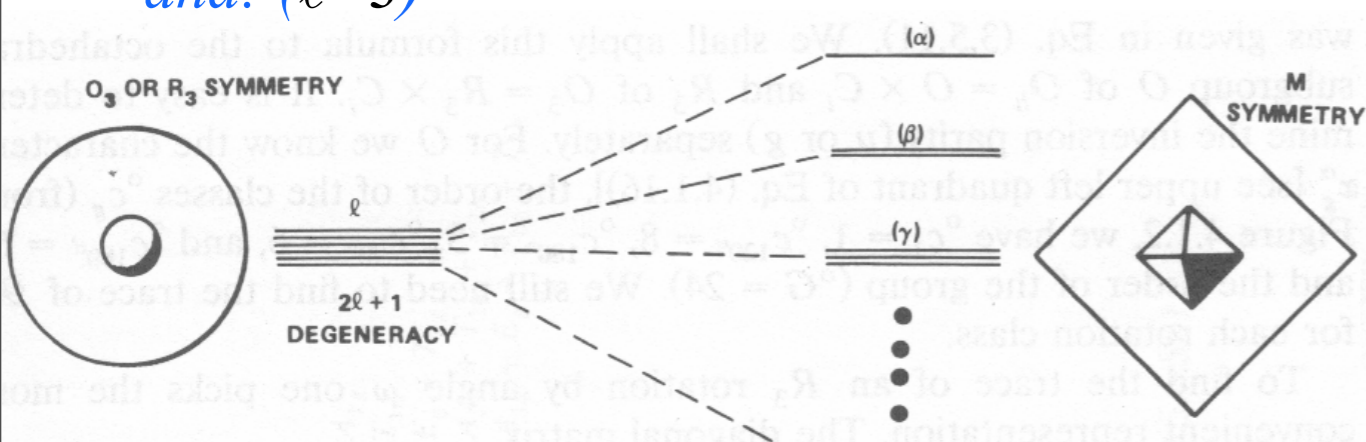

$$D^\ell(\mathbf{R}) = \begin{pmatrix} D_{\ell,\ell} & & & \\ & \dots & & \\ & & D_{\ell,-\ell} & \\ & & & \dots \\ & & & & D_{-\ell,-\ell} \end{pmatrix} \xrightarrow{M \cong} \begin{pmatrix} D^\alpha(\mathbf{R}) \\ D^\beta(\mathbf{R}) \\ D^\gamma(\mathbf{R}) \end{pmatrix}$$

$U(2)$ characters
from Lecture 12.6 p.134 :

$\chi^\ell(\Theta)$	$\Theta=0$	$\mathbf{R}_x \pi$	$\mathbf{R}_y \pi$	$\mathbf{R}_z \pi$
$\ell=0$	1	1	1	1
1	3	-1	-1	-1
2	5	1	1	1
3	7	-1	-1	-1
4	9	1	1	1
5	11	-1	-1	-1
6	13	1	1	1
7	15	-1	-1	-1
8	17	1	1	1

$$\chi^\ell\left(\frac{2\pi}{n}\right) = \frac{\sin\left(\frac{(2\ell+1)\pi}{n}\right)}{\sin\left(\frac{\pi}{n}\right)}$$

$$\chi^\ell(\Theta) = \frac{\sin\left(\left(\ell + \frac{1}{2}\right)\Theta\right)}{\sin\left(\frac{\Theta}{2}\right)}$$

...and Lect.13 p.79

D_2 characters:

D_2	1	\mathbf{R}_x	\mathbf{R}_y	\mathbf{R}_z
A_1	1	1	1	1
A_2	1	-1	1	-1
B_1	1	1	-1	-1
B_2	1	-1	-1	1

$R(3)$ character

where: $2\ell+1$

is ℓ -orbital dimension

$f^{(\alpha)}(\ell)$	f^{A_1}	f^{A_2}	f^{B_1}	f^{B_2}	
$\ell=0$	1	.	.	.	$1A_1$
1	.	1	1	1	$0A_1 \oplus A_2 \oplus B_1 \oplus B_2$
2	2	1	1	1	$2A_1 \oplus A_2 \oplus B_1 \oplus B_2$
3	1	2	2	2	$1A_1 \oplus 2A_2 \oplus 2B_1 \oplus 2B_2$

f -formula better than trial&error

$$\frac{1}{4} \begin{vmatrix} 1 & 1 & 1 & 1 \\ 7 & -1 & -1 & -1 \end{vmatrix} = \frac{7-1-1-1}{4} = 1$$

$$\frac{1}{4} \begin{vmatrix} 1 & -1 & 1 & -1 \\ 7 & -1 & -1 & -1 \end{vmatrix} = \frac{7+1-1+1}{4} = 2$$

Atomic ℓ -level or $2\ell+1$ -multiplet splitting in D_2

Here we apply that to D_2 level splitting

Example: ($\ell=1$) $f^{(b)} = \frac{1}{D_2} \sum_{\kappa_k \in D_2} \kappa_k \chi_k^{(b)*} \chi_k^{(\ell)} = \frac{1}{4} \sum_{g \in D_2} \chi_k^{(b)*} \chi_k^{(\ell)}$
 and: ($\ell=2$)
 and: ($\ell=3$) etc.

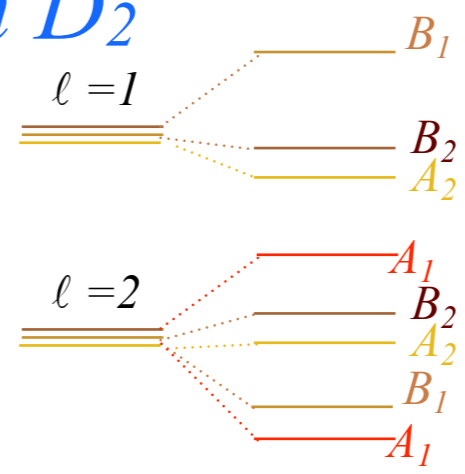

- $\ell=0, s$ -singlet
 $2\ell+1=1$
- $\ell=1, p$ -triplet
 $2\ell+1=3$
- $\ell=2, d$ -quintet
 $2\ell+1=5$
- $\ell=3, f$ -septet
 $2\ell+1=7$
- $\ell=4, g$ -nonet
 $2\ell+1=9$
- $\ell=5, h$ -(11)-let
 $2\ell+1=11$
- ...

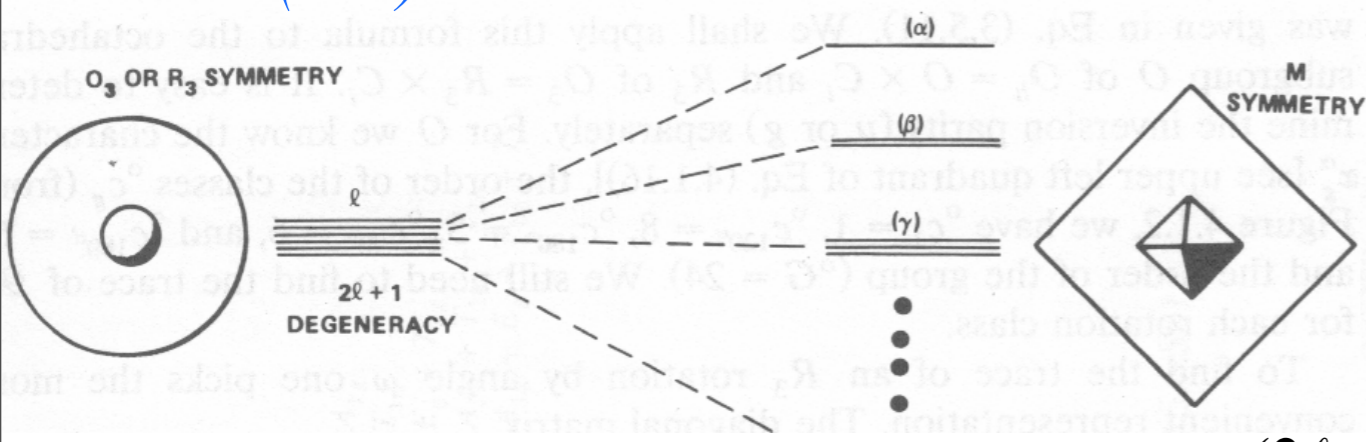

$$D^\ell(\mathbf{R}) = \begin{pmatrix} D_{\ell,\ell} & \dots & D_{\ell,-\ell} \\ D_{\ell-1,\ell} & & \\ \vdots & & \\ D_{-\ell,\ell} & \dots & D_{-\ell,-\ell} \end{pmatrix} \xrightarrow{M \cong} \begin{pmatrix} D^\alpha(\mathbf{R}) \\ D^\beta(\mathbf{R}) \\ D^\gamma(\mathbf{R}) \end{pmatrix}$$

$U(2)$ characters
from Lecture 12.6 p.134 :

$\chi^\ell(\Theta)$	$\Theta=0$	$\mathbf{R}_x \pi$	$\mathbf{R}_y \pi$	$\mathbf{R}_z \pi$
$\ell=0$	1	1	1	1
1	3	-1	-1	-1
2	5	1	1	1
3	7	-1	-1	-1
4	9	1	1	1
5	11	-1	-1	-1
6	13	1	1	1
7	15	-1	-1	-1
8	17	1	1	1

$$\chi^\ell\left(\frac{2\pi}{n}\right) = \frac{\sin\left(\frac{(2\ell+1)\pi}{n}\right)}{\sin\left(\frac{\pi}{n}\right)}$$

$$\chi^\ell(\Theta) = \frac{\sin\left(\left(\ell + \frac{1}{2}\right)\Theta\right)}{\sin\left(\frac{\Theta}{2}\right)}$$

...and Lect.13 p.79
 D_2 characters:

D_2	1	\mathbf{R}_x	\mathbf{R}_y	\mathbf{R}_z
A_1	1	1	1	1
A_2	1	-1	1	-1
B_1	1	1	-1	-1
B_2	1	-1	-1	1

$R(3)$ character
where: $2\ell+1$

is ℓ -orbital dimension

$f^{(\alpha)}(\ell)$	f^{A_1}	f^{A_2}	f^{B_1}	f^{B_2}	
$\ell=0$	1	.	.	.	$1A_1$
1	.	1	1	1	$0A_1 \oplus A_2 \oplus B_1 \oplus B_2$
2	2	1	1	1	$2A_1 \oplus A_2 \oplus B_1 \oplus B_2$
3	1	2	2	2	$1A_1 \oplus 2A_2 \oplus 2B_1 \oplus 2B_2$
4	3	2	2	2	$3A_1 \oplus 2A_2 \oplus 2B_1 \oplus 2B_2$
5	2	3	3	3	$2A_1 \oplus 3A_2 \oplus 3B_1 \oplus 3B_2$
6	4	3	3	3	$4A_1 \oplus 3A_2 \oplus 3B_1 \oplus 3B_2$
7	3	4	4	4	$3A_1 \oplus 4A_2 \oplus 4B_1 \oplus 4B_2$

Review :

*Symmetric rigid quantum rotor analysis of $R(2)$ Hamiltonian $\mathbf{H} = B\mathbf{J}_x^2 + B\mathbf{J}_y^2 + C\mathbf{J}_z^2$
Rotational Energy Surfaces (RE or RES) and $R(3) \sim U(2)$ representations*

*Asymmetric rigid quantum rotor analysis of D_2 Hamiltonian $\mathbf{H} = A\mathbf{J}_x^2 + B\mathbf{J}_y^2 + C\mathbf{J}_z^2$
RES and Multipole \mathbf{T}_q^k tensor expansions*

Atomic or molecular $R(3)$ ℓ -level or $2\ell+1$ -multiplet splitting (Review of D_3)

$R(3) \supset D_2$ character analysis of ℓ -level or $2\ell+1$ -multiplet splitting in D_2

Detailed angular momentum operator analysis for $J=1-2$ for D_2 symmetry

Asymmetric rotor levels and RES plots for high- J

Octahedral semi-rigid quantum rotor analysis of O_h Hamiltonian $\mathbf{H} = B\mathbf{J} \cdot \mathbf{J} + t_{044}\mathbf{T}^{[4]}$

Spherical rotor levels and RES plots of O_h tensor eigenvalues

$R(3) \subset O(3) \supset O_h \supset O$ character analysis of ℓ -level or $2\ell+1$ -multiplet splitting in O

SF_6 spectral fine structure

CF_4 spectral fine structure

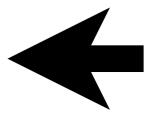
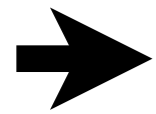

Detailed angular momentum operator analysis for $j=1-2$ for D_2 symmetry

j, m, n formulas for momentum operator matrix elements:

(From Lecture 24 p. 36)

$$n_{\uparrow} = j + m, \quad n_{\downarrow} = j - m$$

$$|j, m\rangle = \frac{(\mathbf{a}_{\uparrow}^{\dagger})^{j+m} (\mathbf{a}_{\downarrow}^{\dagger})^{j-m}}{\sqrt{(j+m)!} \sqrt{(j-m)!}} |0, 0\rangle = \frac{|n_{\uparrow}, n_{\downarrow}\rangle}{\sqrt{(n_{\uparrow})!} \sqrt{(n_{\downarrow})!}}$$

$$\mathbf{a}_{\uparrow}^{\dagger} \mathbf{a}_{\downarrow} = \mathbf{J}_{+} = \mathbf{J}_X + i\mathbf{J}_Y$$

$$\mathbf{a}_{\downarrow}^{\dagger} \mathbf{a}_{\uparrow} = \mathbf{J}_{-} = \mathbf{J}_X - i\mathbf{J}_Y = \mathbf{J}_{+}^{\dagger}$$

$$\mathbf{J}_X = \frac{1}{2} [\mathbf{J}_{+} + \mathbf{J}_{-}]$$

$$\mathbf{J}_Y = \frac{-i}{2} [\mathbf{J}_{+} - \mathbf{J}_{-}]$$

$$\begin{aligned} \mathbf{a}_{\uparrow}^{\dagger} \mathbf{a}_{\downarrow} |n_{\uparrow}, n_{\downarrow}\rangle &= \sqrt{n_{\uparrow}+1} \sqrt{n_{\downarrow}} |n_{\uparrow}+1, n_{\downarrow}-1\rangle \Rightarrow \mathbf{J}_{+} |j, m\rangle = \sqrt{j+m+1} \sqrt{j-m} |j, m+1\rangle \\ \mathbf{a}_{\downarrow}^{\dagger} \mathbf{a}_{\uparrow} |n_{\uparrow}, n_{\downarrow}\rangle &= \sqrt{n_{\uparrow}} \sqrt{n_{\downarrow}+1} |n_{\uparrow}-1, n_{\downarrow}+1\rangle \Rightarrow \mathbf{J}_{-} |j, m\rangle = \sqrt{j+m} \sqrt{j-m+1} |j, m-1\rangle \end{aligned}$$

Detailed angular momentum operator analysis for $j=1-2$ for D_2 symmetry

j, m, n formulas for momentum operator matrix elements:

(From Lecture 24 p. 36)

$$n_{\uparrow} = j + m, \quad n_{\downarrow} = j - m$$

$$|j, m\rangle = \frac{(\mathbf{a}_{\uparrow}^{\dagger})^{j+m} (\mathbf{a}_{\downarrow}^{\dagger})^{j-m}}{\sqrt{(j+m)!} \sqrt{(j-m)!}} |0, 0\rangle = \frac{|n_{\uparrow}, n_{\downarrow}\rangle}{\sqrt{(n_{\uparrow})!} \sqrt{(n_{\downarrow})!}}$$

$$\begin{aligned} \mathbf{a}_{\uparrow}^{\dagger} \mathbf{a}_{\downarrow} |n_{\uparrow}, n_{\downarrow}\rangle &= \sqrt{n_{\uparrow}+1} \sqrt{n_{\downarrow}} |n_{\uparrow}+1, n_{\downarrow}-1\rangle \Rightarrow \mathbf{J}_{+} |j, m\rangle = \sqrt{j+m+1} \sqrt{j-m} |j, m+1\rangle \\ \mathbf{a}_{\downarrow}^{\dagger} \mathbf{a}_{\uparrow} |n_{\uparrow}, n_{\downarrow}\rangle &= \sqrt{n_{\uparrow}} \sqrt{n_{\downarrow}+1} |n_{\uparrow}-1, n_{\downarrow}+1\rangle \Rightarrow \mathbf{J}_{-} |j, m\rangle = \sqrt{j+m} \sqrt{j-m+1} |j, m-1\rangle \end{aligned}$$

$$\mathbf{a}_{\uparrow}^{\dagger} \mathbf{a}_{\downarrow} = \mathbf{J}_{+} = \mathbf{J}_X + i\mathbf{J}_Y$$

$$\mathbf{a}_{\downarrow}^{\dagger} \mathbf{a}_{\uparrow} = \mathbf{J}_{-} = \mathbf{J}_X - i\mathbf{J}_Y = \mathbf{J}_{+}^{\dagger}$$

$$\mathbf{J}_X = \frac{1}{2} [\mathbf{J}_{+} + \mathbf{J}_{-}]$$

$$\mathbf{J}_Y = \frac{-i}{2} [\mathbf{J}_{+} - \mathbf{J}_{-}]$$

LAB matrix elements use the usual atomic formula:

$$\langle J, m', n' | \mathbf{J}_X | J, m, n \rangle = D_{m', m}^J (\mathbf{J}_X) \delta_{n' n} = \frac{1}{2} \left[\delta_{m' m+1} \sqrt{(j-m)(j+m+1)} + \delta_{m' m-1} \sqrt{(j+m)(j-m+1)} \right] \delta_{n' n}$$

$$\langle J, m', n' | \mathbf{J}_Y | J, m, n \rangle = D_{m', m}^J (\mathbf{J}_Y) \delta_{n' n} = \frac{-i}{2} \left[\delta_{m' m+1} \sqrt{(j-m)(j+m+1)} - \delta_{m' m-1} \sqrt{(j+m)(j-m+1)} \right] \delta_{n' n}$$

$$\langle J, m', n' | \mathbf{J}_Z | J, m, n \rangle = D_{m', m}^J (\mathbf{J}_Z) \delta_{n' n} = \delta_{m' m} m \delta_{n' n}$$

Detailed angular momentum operator analysis for $j=1-2$ for D_2 symmetry

j, m, n formulas for momentum operator matrix elements:

(From Lecture 24 p. 36)

$$n_{\uparrow} = j + m, \quad n_{\downarrow} = j - m$$

$$\left| \begin{matrix} j \\ m \end{matrix} \right\rangle = \frac{(\mathbf{a}_{\uparrow}^{\dagger})^{j+m} (\mathbf{a}_{\downarrow}^{\dagger})^{j-m}}{\sqrt{(j+m)!} \sqrt{(j-m)!}} \left| 0, 0 \right\rangle = \frac{\left| n_{\uparrow}, n_{\downarrow} \right\rangle}{\sqrt{(n_{\uparrow})!} \sqrt{(n_{\downarrow})!}}$$

$$\begin{aligned} \mathbf{a}_{\uparrow}^{\dagger} \mathbf{a}_{\downarrow} \left| n_{\uparrow}, n_{\downarrow} \right\rangle &= \sqrt{n_{\uparrow}+1} \sqrt{n_{\downarrow}} \left| n_{\uparrow}+1, n_{\downarrow}-1 \right\rangle \Rightarrow \mathbf{J}_{+} \left| \begin{matrix} j \\ m \end{matrix} \right\rangle = \sqrt{j+m+1} \sqrt{j-m} \left| \begin{matrix} j \\ m+1 \end{matrix} \right\rangle \\ \mathbf{a}_{\downarrow}^{\dagger} \mathbf{a}_{\uparrow} \left| n_{\uparrow}, n_{\downarrow} \right\rangle &= \sqrt{n_{\uparrow}} \sqrt{n_{\downarrow}+1} \left| n_{\uparrow}-1, n_{\downarrow}+1 \right\rangle \Rightarrow \mathbf{J}_{-} \left| \begin{matrix} j \\ m \end{matrix} \right\rangle = \sqrt{j+m} \sqrt{j-m+1} \left| \begin{matrix} j \\ m-1 \end{matrix} \right\rangle \end{aligned}$$

$$\mathbf{a}_{\uparrow}^{\dagger} \mathbf{a}_{\downarrow} = \mathbf{J}_{+} = \mathbf{J}_X + i\mathbf{J}_Y$$

$$\mathbf{a}_{\downarrow}^{\dagger} \mathbf{a}_{\uparrow} = \mathbf{J}_{-} = \mathbf{J}_X - i\mathbf{J}_Y = \mathbf{J}_{+}^{\dagger}$$

$$\mathbf{J}_X = \frac{1}{2} [\mathbf{J}_{+} + \mathbf{J}_{-}]$$

$$\mathbf{J}_Y = \frac{-i}{2} [\mathbf{J}_{+} - \mathbf{J}_{-}]$$

LAB matrix elements use the usual atomic formula:

$$\left\langle \begin{matrix} J \\ m', n' \end{matrix} \left| \mathbf{J}_X \right| \begin{matrix} J \\ m, n \end{matrix} \right\rangle = D_{m', m}^J (\mathbf{J}_X) \delta_{n' n} = \frac{1}{2} \left[\delta_{m' m+1} \sqrt{(j-m)(j+m+1)} + \delta_{m' m-1} \sqrt{(j+m)(j-m+1)} \right] \delta_{n' n}$$

$$\left\langle \begin{matrix} J \\ m', n' \end{matrix} \left| \mathbf{J}_Y \right| \begin{matrix} J \\ m, n \end{matrix} \right\rangle = D_{m', m}^J (\mathbf{J}_Y) \delta_{n' n} = \frac{-i}{2} \left[\delta_{m' m+1} \sqrt{(j-m)(j+m+1)} - \delta_{m' m-1} \sqrt{(j+m)(j-m+1)} \right] \delta_{n' n}$$

$$\left\langle \begin{matrix} J \\ m', n' \end{matrix} \left| \mathbf{J}_Z \right| \begin{matrix} J \\ m, n \end{matrix} \right\rangle = D_{m', m}^J (\mathbf{J}_Z) \delta_{n' n} = \delta_{m' m} m \delta_{n' n}$$

BOD matrix elements are the same after switching m 's into n 's

and changing sign of \mathbf{J}_Y matrix (*-conjugation)

$$\left\langle \begin{matrix} J \\ m', n' \end{matrix} \left| \mathbf{J}_{\bar{X}} \right| \begin{matrix} J \\ m, n \end{matrix} \right\rangle = \delta_{m' m} D_{n', n}^{J*} (\mathbf{J}_{\bar{X}}) = \frac{1}{2} \delta_{m' m} \left[\sqrt{(j-n)(j+n+1)} \delta_{n' n+1} + \sqrt{(j+n)(j-n+1)} \delta_{n' n-1} \right]$$

$$\left\langle \begin{matrix} J \\ m', n' \end{matrix} \left| \mathbf{J}_{\bar{Y}} \right| \begin{matrix} J \\ m, n \end{matrix} \right\rangle = \delta_{m' m} D_{n', n}^{J*} (\mathbf{J}_{\bar{Y}}) = \frac{+i}{2} \delta_{m' m} \left[\sqrt{(j-n)(j+n+1)} \delta_{n' n+1} - \sqrt{(j+n)(j-n+1)} \delta_{n' n-1} \right]$$

$$\left\langle \begin{matrix} J \\ m', n' \end{matrix} \left| \mathbf{J}_{\bar{Z}} \right| \begin{matrix} J \\ m, n \end{matrix} \right\rangle = \delta_{m' m} D_{n', n}^{J*} (\mathbf{J}_{\bar{Z}}) = \delta_{m' m} n \delta_{n' n}$$

$$\mathbf{H} = \frac{1}{2} \left(\frac{\mathbf{J}_{\bar{X}}^2}{I_{\bar{X}}} + \frac{\mathbf{J}_{\bar{Y}}^2}{I_{\bar{Y}}} + \frac{\mathbf{J}_{\bar{Z}}^2}{I_{\bar{Z}}} \right) = A\mathbf{J}_{\bar{X}}^2 + B\mathbf{J}_{\bar{Y}}^2 + C\mathbf{J}_{\bar{Z}}^2$$

First are matrix formulas for **BOD** J^2 components.

$$\begin{aligned} \mathbf{J}_{\bar{X}}^2 \left| J_{m,n} \right\rangle &= \frac{1}{2} \sqrt{(j-n)(j+n+1)} \mathbf{J}_{\bar{X}} \left| J_{m,n+1} \right\rangle &= \frac{1}{4} \sqrt{(j-n)(j+n+1)} \sqrt{(j-n-1)(j+n+2)} \left| J_{m,n+2} \right\rangle + \frac{1}{4} (j-n)(j+n+1) \left| J_{m,n} \right\rangle \\ &+ \frac{1}{2} \sqrt{(j+n)(j-n+1)} \mathbf{J}_{\bar{X}} \left| J_{m,n-1} \right\rangle &+ \frac{1}{4} \sqrt{(j+n)(j-n+1)} \sqrt{(j+n-1)(j-n+2)} \left| J_{m,n-2} \right\rangle + \frac{1}{4} (j+n)(j-n+1) \left| J_{m,n} \right\rangle \\ &= \frac{\sqrt{(j-n)(j-n-1)(j+n+1)(j+n+2)}}{4} \left| J_{m,n+2} \right\rangle &+ \frac{j(j+1)-n^2}{2} \left| J_{m,n} \right\rangle + \frac{\sqrt{(j+n)(j+n-1)(j-n+1)(j-n+2)}}{4} \left| J_{m,n-2} \right\rangle \end{aligned}$$

$$\begin{aligned} \mathbf{J}_{\bar{Y}}^2 \left| J_{m,n} \right\rangle &= \frac{i}{2} \sqrt{(j-n)(j+n+1)} \mathbf{J}_{\bar{Y}} \left| J_{m,n+1} \right\rangle &= -\frac{1}{4} \sqrt{(j-n)(j+n+1)} \sqrt{(j-n-1)(j+n+2)} \left| J_{m,n+2} \right\rangle + \frac{1}{4} (j-n)(j+n+1) \left| J_{m,n} \right\rangle \\ &- \frac{i}{2} \sqrt{(j+n)(j-n+1)} \mathbf{J}_{\bar{Y}} \left| J_{m,n-1} \right\rangle &-\frac{1}{4} \sqrt{(j+n)(j-n+1)} \sqrt{(j+n-1)(j-n+2)} \left| J_{m,n-2} \right\rangle + \frac{1}{4} (j+n)(j-n+1) \left| J_{m,n} \right\rangle \\ &= -\frac{\sqrt{(j-n)(j-n-1)(j+n+1)(j+n+2)}}{4} \left| J_{m,n+2} \right\rangle &+ \frac{j(j+1)-n^2}{2} \left| J_{m,n} \right\rangle - \frac{\sqrt{(j+n)(j+n-1)(j-n+1)(j-n+2)}}{4} \left| J_{m,n-2} \right\rangle \end{aligned}$$

$$\mathbf{J}_{\bar{Z}}^2 \left| J_{m,n} \right\rangle = n^2 \left| J_{m,n} \right\rangle$$

This gives the rigid asymmetric-top matrix formula for general A, B, C and J, n :

$$\begin{aligned} (A\mathbf{J}_{\bar{X}}^2 + B\mathbf{J}_{\bar{Y}}^2 + C\mathbf{J}_{\bar{Z}}^2) \left| J_{m,n} \right\rangle &= \\ &= (A-B) \frac{\sqrt{(j-n)(j-n-1)(j+n+1)(j+n+2)}}{4} \left| J_{m,n+2} \right\rangle + [(A+B) \frac{j(j+1)-n^2}{2} + Cn^2] \left| J_{m,n} \right\rangle + (A-B) \frac{\sqrt{(j+n)(j+n-1)(j-n+1)(j-n+2)}}{4} \left| J_{m,n-2} \right\rangle \end{aligned}$$

Review :

*Symmetric rigid quantum rotor analysis of $R(2)$ Hamiltonian $\mathbf{H} = B\mathbf{J}_x^2 + B\mathbf{J}_y^2 + C\mathbf{J}_z^2$
Rotational Energy Surfaces (RE or RES) and $R(3) \sim U(2)$ representations*

*Asymmetric rigid quantum rotor analysis of D_2 Hamiltonian $\mathbf{H} = A\mathbf{J}_x^2 + B\mathbf{J}_y^2 + C\mathbf{J}_z^2$
RES and Multipole \mathbf{T}_q^k tensor expansions*

Atomic or molecular $R(3)$ ℓ -level or $2\ell+1$ -multiplet splitting (Review of D_3)

$R(3) \supset D_2$ character analysis of ℓ -level or $2\ell+1$ -multiplet splitting in D_2

Detailed angular momentum operator analysis for $J=1-2$ for D_2 symmetry

Asymmetric rotor levels and RES plots for high- J

Octahedral semi-rigid quantum rotor analysis of O_h Hamiltonian $\mathbf{H} = B\mathbf{J} \cdot \mathbf{J} + t_{044}\mathbf{T}^{[4]}$

Spherical rotor levels and RES plots of O_h tensor eigenvalues

$R(3) \subset O(3) \supset O_h \supset O$ character analysis of ℓ -level or $2\ell+1$ -multiplet splitting in O

SF_6 spectral fine structure

CF_4 spectral fine structure

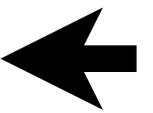
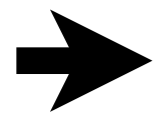

$(J=1)$ -Matrix for $A=1, B=2, C=3$.

$$\begin{aligned} \langle {}^1_{m,n'} | \mathbf{J}_{\bar{X}} | {}^1_{m,n} \rangle &= \begin{pmatrix} \cdot & \frac{\sqrt{2}}{2} & \cdot \\ \frac{\sqrt{2}}{2} & \cdot & \frac{\sqrt{2}}{2} \\ \cdot & \frac{\sqrt{2}}{2} & \cdot \end{pmatrix}, & \langle {}^1_{m,n'} | \mathbf{J}_{\bar{Y}} | {}^1_{m,n} \rangle &= \begin{pmatrix} \cdot & \frac{i\sqrt{2}}{2} & \cdot \\ -\frac{i\sqrt{2}}{2} & \cdot & \frac{i\sqrt{2}}{2} \\ \cdot & -\frac{i\sqrt{2}}{2} & \cdot \end{pmatrix}, & \langle {}^1_{m,n'} | \mathbf{J}_{\bar{Z}} | {}^1_{m,n} \rangle &= \begin{pmatrix} +1 & \cdot & \cdot \\ \cdot & 0 & \cdot \\ \cdot & \cdot & -1 \end{pmatrix} \\ \langle {}^1_{m,n'} | \mathbf{J}_{\bar{X}}^2 | {}^1_{m,n} \rangle &= \begin{pmatrix} \frac{1}{2} & \cdot & \frac{1}{2} \\ \cdot & 1 & \cdot \\ \frac{1}{2} & \cdot & \frac{1}{2} \end{pmatrix}, & \langle {}^1_{m,n'} | \mathbf{J}_{\bar{Y}}^2 | {}^1_{m,n} \rangle &= \begin{pmatrix} \frac{1}{2} & \cdot & -\frac{1}{2} \\ \cdot & 1 & \cdot \\ -\frac{1}{2} & \cdot & \frac{1}{2} \end{pmatrix}, & \langle {}^1_{m,n'} | \mathbf{J}_{\bar{Z}}^2 | {}^1_{m,n} \rangle &= \begin{pmatrix} +1 & \cdot & \cdot \\ \cdot & 0 & \cdot \\ \cdot & \cdot & +1 \end{pmatrix}. \end{aligned}$$

$(J=1)$ -Matrix for $A=1, B=2, C=3$.

$$\langle {}^1_{m,n'} | \mathbf{J}_{\bar{X}} | {}^1_{m,n} \rangle = \begin{pmatrix} \cdot & \frac{\sqrt{2}}{2} & \cdot \\ \frac{\sqrt{2}}{2} & \cdot & \frac{\sqrt{2}}{2} \\ \cdot & \frac{\sqrt{2}}{2} & \cdot \end{pmatrix}, \quad \langle {}^1_{m,n'} | \mathbf{J}_{\bar{Y}} | {}^1_{m,n} \rangle = \begin{pmatrix} \cdot & \frac{i\sqrt{2}}{2} & \cdot \\ -\frac{i\sqrt{2}}{2} & \cdot & \frac{i\sqrt{2}}{2} \\ \cdot & -\frac{i\sqrt{2}}{2} & \cdot \end{pmatrix}, \quad \langle {}^1_{m,n'} | \mathbf{J}_{\bar{Z}} | {}^1_{m,n} \rangle = \begin{pmatrix} +1 & \cdot & \cdot \\ \cdot & 0 & \cdot \\ \cdot & \cdot & -1 \end{pmatrix}$$

$$\langle {}^1_{m,n'} | \mathbf{J}_{\bar{X}}^2 | {}^1_{m,n} \rangle = \begin{pmatrix} \frac{1}{2} & \cdot & \frac{1}{2} \\ \cdot & 1 & \cdot \\ \frac{1}{2} & \cdot & \frac{1}{2} \end{pmatrix}, \quad \langle {}^1_{m,n'} | \mathbf{J}_{\bar{Y}}^2 | {}^1_{m,n} \rangle = \begin{pmatrix} \frac{1}{2} & \cdot & -\frac{1}{2} \\ \cdot & 1 & \cdot \\ -\frac{1}{2} & \cdot & \frac{1}{2} \end{pmatrix}, \quad \langle {}^1_{m,n'} | \mathbf{J}_{\bar{Z}}^2 | {}^1_{m,n} \rangle = \begin{pmatrix} +1 & \cdot & \cdot \\ \cdot & 0 & \cdot \\ \cdot & \cdot & +1 \end{pmatrix}.$$

$$\langle A\mathbf{J}_{\bar{X}}^2 + B\mathbf{J}_{\bar{Y}}^2 + C\mathbf{J}_{\bar{Z}}^2 \rangle^{J=1} = \begin{pmatrix} \frac{A}{2} + \frac{B}{2} + C & \cdot & \frac{A}{2} - \frac{B}{2} \\ \cdot & A + B & \cdot \\ \frac{A}{2} - \frac{B}{2} & \cdot & \frac{A}{2} + \frac{B}{2} + C \end{pmatrix} = \begin{pmatrix} \frac{1}{2} + \frac{2}{2} + 3 & \cdot & \frac{1}{2} - \frac{2}{2} \\ \cdot & 1 + 2 & \cdot \\ \frac{1}{2} - \frac{2}{2} & \cdot & \frac{1}{2} + \frac{2}{2} + 3 \end{pmatrix} = \begin{pmatrix} \frac{9}{2} & \cdot & -\frac{1}{2} \\ \cdot & 3 & \cdot \\ -\frac{1}{2} & \cdot & \frac{9}{2} \end{pmatrix}$$

$f^{(\alpha)}(\ell)$	f^{A_1}	f^{A_2}	f^{B_1}	f^{B_2}	
$\ell = 0$	1	·	·		$1A_1$
1	·	1	1	1	$0A_1 \oplus A_2 \oplus B_1 \oplus B_2$

$(J=1)$ -Matrix for $A=1, B=2, C=3$.

$$\langle {}^1_{m,n'} | \mathbf{J}_{\bar{X}} | {}^1_{m,n} \rangle = \begin{pmatrix} \cdot & \frac{\sqrt{2}}{2} & \cdot \\ \frac{\sqrt{2}}{2} & \cdot & \frac{\sqrt{2}}{2} \\ \cdot & \frac{\sqrt{2}}{2} & \cdot \end{pmatrix}, \quad \langle {}^1_{m,n'} | \mathbf{J}_{\bar{Y}} | {}^1_{m,n} \rangle = \begin{pmatrix} \cdot & \frac{i\sqrt{2}}{2} & \cdot \\ -\frac{i\sqrt{2}}{2} & \cdot & \frac{i\sqrt{2}}{2} \\ \cdot & -\frac{i\sqrt{2}}{2} & \cdot \end{pmatrix}, \quad \langle {}^1_{m,n'} | \mathbf{J}_{\bar{Z}} | {}^1_{m,n} \rangle = \begin{pmatrix} +1 & \cdot & \cdot \\ \cdot & 0 & \cdot \\ \cdot & \cdot & -1 \end{pmatrix}$$

$$\langle {}^1_{m,n'} | \mathbf{J}_{\bar{X}}^2 | {}^1_{m,n} \rangle = \begin{pmatrix} \frac{1}{2} & \cdot & \frac{1}{2} \\ \cdot & 1 & \cdot \\ \frac{1}{2} & \cdot & \frac{1}{2} \end{pmatrix}, \quad \langle {}^1_{m,n'} | \mathbf{J}_{\bar{Y}}^2 | {}^1_{m,n} \rangle = \begin{pmatrix} \frac{1}{2} & \cdot & -\frac{1}{2} \\ \cdot & 1 & \cdot \\ -\frac{1}{2} & \cdot & \frac{1}{2} \end{pmatrix}, \quad \langle {}^1_{m,n'} | \mathbf{J}_{\bar{Z}}^2 | {}^1_{m,n} \rangle = \begin{pmatrix} +1 & \cdot & \cdot \\ \cdot & 0 & \cdot \\ \cdot & \cdot & +1 \end{pmatrix}.$$

$$\langle A\mathbf{J}_{\bar{X}}^2 + B\mathbf{J}_{\bar{Y}}^2 + C\mathbf{J}_{\bar{Z}}^2 \rangle^{J=1} = \begin{pmatrix} \frac{A}{2} + \frac{B}{2} + C & \cdot & \frac{A}{2} - \frac{B}{2} \\ \cdot & A+B & \cdot \\ \frac{A}{2} - \frac{B}{2} & \cdot & \frac{A}{2} + \frac{B}{2} + C \end{pmatrix} = \begin{pmatrix} \frac{1}{2} + \frac{2}{2} + 3 & \cdot & \frac{1}{2} - \frac{2}{2} \\ \cdot & 1+2 & \cdot \\ \frac{1}{2} - \frac{2}{2} & \cdot & \frac{1}{2} + \frac{2}{2} + 3 \end{pmatrix} = \begin{pmatrix} \frac{9}{2} & \cdot & -\frac{1}{2} \\ \cdot & 3 & \cdot \\ -\frac{1}{2} & \cdot & \frac{9}{2} \end{pmatrix}$$

eigen-values: $(B+C=5, A+B=3, A+C=4)$

$$\langle \text{eigen-vectors:} \begin{pmatrix} 1/\sqrt{2} & 0 & 1/\sqrt{2} \\ 0 & 1 & 0 \\ -1/\sqrt{2} & 0 & +1/\sqrt{2} \end{pmatrix}$$

$f^{(\alpha)}(\ell)$	f^{A_1}	f^{A_2}	f^{B_1}	f^{B_2}	
$\ell=0$	1	·	·		$1A_1$
1	·	1	1	1	$0A_1 \oplus A_2 \oplus B_1 \oplus B_2$

$(J=1)$ -Matrix for $A=1, B=2, C=3$.

$$\langle 1_{m,n'} | \mathbf{J}_{\bar{X}} | 1_{m,n} \rangle = \begin{pmatrix} \cdot & \frac{\sqrt{2}}{2} & \cdot \\ \frac{\sqrt{2}}{2} & \cdot & \frac{\sqrt{2}}{2} \\ \cdot & \frac{\sqrt{2}}{2} & \cdot \end{pmatrix}, \quad \langle 1_{m,n'} | \mathbf{J}_{\bar{Y}} | 1_{m,n} \rangle = \begin{pmatrix} \cdot & \frac{i\sqrt{2}}{2} & \cdot \\ -\frac{i\sqrt{2}}{2} & \cdot & \frac{i\sqrt{2}}{2} \\ \cdot & -\frac{i\sqrt{2}}{2} & \cdot \end{pmatrix}, \quad \langle 1_{m,n'} | \mathbf{J}_{\bar{Z}} | 1_{m,n} \rangle = \begin{pmatrix} +1 & \cdot & \cdot \\ \cdot & 0 & \cdot \\ \cdot & \cdot & -1 \end{pmatrix}$$

$$\langle 1_{m,n'} | \mathbf{J}_{\bar{X}}^2 | 1_{m,n} \rangle = \begin{pmatrix} \frac{1}{2} & \cdot & \frac{1}{2} \\ \cdot & 1 & \cdot \\ \frac{1}{2} & \cdot & \frac{1}{2} \end{pmatrix}, \quad \langle 1_{m,n'} | \mathbf{J}_{\bar{Y}}^2 | 1_{m,n} \rangle = \begin{pmatrix} \frac{1}{2} & \cdot & -\frac{1}{2} \\ \cdot & 1 & \cdot \\ -\frac{1}{2} & \cdot & \frac{1}{2} \end{pmatrix}, \quad \langle 1_{m,n'} | \mathbf{J}_{\bar{Z}}^2 | 1_{m,n} \rangle = \begin{pmatrix} +1 & \cdot & \cdot \\ \cdot & 0 & \cdot \\ \cdot & \cdot & +1 \end{pmatrix}.$$

$$\langle A\mathbf{J}_{\bar{X}}^2 + B\mathbf{J}_{\bar{Y}}^2 + C\mathbf{J}_{\bar{Z}}^2 \rangle^{J=1} = \begin{pmatrix} \frac{A}{2} + \frac{B}{2} + C & \cdot & \frac{A}{2} - \frac{B}{2} \\ \cdot & A+B & \cdot \\ \frac{A}{2} - \frac{B}{2} & \cdot & \frac{A}{2} + \frac{B}{2} + C \end{pmatrix} = \begin{pmatrix} \frac{1}{2} + \frac{2}{2} + 3 & \cdot & \frac{1}{2} - \frac{2}{2} \\ \cdot & 1+2 & \cdot \\ \frac{1}{2} - \frac{2}{2} & \cdot & \frac{1}{2} + \frac{2}{2} + 3 \end{pmatrix} = \begin{pmatrix} \frac{9}{2} & \cdot & -\frac{1}{2} \\ \cdot & 3 & \cdot \\ -\frac{1}{2} & \cdot & \frac{9}{2} \end{pmatrix}$$

eigen-values: $(B+C=5, A+B=3, A+C=4)$

eigen-vectors: $\begin{pmatrix} 1/\sqrt{2} & 0 & 1/\sqrt{2} \\ 0 & 1 & 0 \\ -1/\sqrt{2} & 0 & +1/\sqrt{2} \end{pmatrix}$

$f^{(\alpha)}(\ell)$	f^{A_1}	f^{A_2}	f^{B_1}	f^{B_2}	
$\ell=0$	1	·	·		$1A_1$
1	·	1	1	1	$0A_1 \oplus A_2 \oplus B_1 \oplus B_2$

D_2	1	R_x	R_y	R_z
A_1	1	1	1	1
A_2	1	-1	1	-1
B_1	1	1	-1	-1
B_2	1	-1	-1	1

$(J=1)$ -Matrix for $A=1, B=2, C=3$.

$$\langle 1_{m,n'} | \mathbf{J}_{\bar{X}} | 1_{m,n} \rangle = \begin{pmatrix} \cdot & \frac{\sqrt{2}}{2} & \cdot \\ \frac{\sqrt{2}}{2} & \cdot & \frac{\sqrt{2}}{2} \\ \cdot & \frac{\sqrt{2}}{2} & \cdot \end{pmatrix}, \quad \langle 1_{m,n'} | \mathbf{J}_{\bar{Y}} | 1_{m,n} \rangle = \begin{pmatrix} \cdot & \frac{i\sqrt{2}}{2} & \cdot \\ -\frac{i\sqrt{2}}{2} & \cdot & \frac{i\sqrt{2}}{2} \\ \cdot & -\frac{i\sqrt{2}}{2} & \cdot \end{pmatrix}, \quad \langle 1_{m,n'} | \mathbf{J}_{\bar{Z}} | 1_{m,n} \rangle = \begin{pmatrix} +1 & \cdot & \cdot \\ \cdot & 0 & \cdot \\ \cdot & \cdot & -1 \end{pmatrix}$$

$$\langle 1_{m,n'} | \mathbf{J}_{\bar{X}}^2 | 1_{m,n} \rangle = \begin{pmatrix} \frac{1}{2} & \cdot & \frac{1}{2} \\ \cdot & 1 & \cdot \\ \frac{1}{2} & \cdot & \frac{1}{2} \end{pmatrix}, \quad \langle 1_{m,n'} | \mathbf{J}_{\bar{Y}}^2 | 1_{m,n} \rangle = \begin{pmatrix} \frac{1}{2} & \cdot & -\frac{1}{2} \\ \cdot & 1 & \cdot \\ -\frac{1}{2} & \cdot & \frac{1}{2} \end{pmatrix}, \quad \langle 1_{m,n'} | \mathbf{J}_{\bar{Z}}^2 | 1_{m,n} \rangle = \begin{pmatrix} +1 & \cdot & \cdot \\ \cdot & 0 & \cdot \\ \cdot & \cdot & +1 \end{pmatrix}.$$

$$\langle A\mathbf{J}_{\bar{X}}^2 + B\mathbf{J}_{\bar{Y}}^2 + C\mathbf{J}_{\bar{Z}}^2 \rangle^{J=1} = \begin{pmatrix} \frac{A}{2} + \frac{B}{2} + C & \cdot & \frac{A}{2} - \frac{B}{2} \\ \cdot & A + B & \cdot \\ \frac{A}{2} - \frac{B}{2} & \cdot & \frac{A}{2} + \frac{B}{2} + C \end{pmatrix} = \begin{pmatrix} \frac{1}{2} + \frac{2}{2} + 3 & \cdot & \frac{1}{2} - \frac{2}{2} \\ \cdot & 1 + 2 & \cdot \\ \frac{1}{2} - \frac{2}{2} & \cdot & \frac{1}{2} + \frac{2}{2} + 3 \end{pmatrix} = \begin{pmatrix} \frac{9}{2} & \cdot & -\frac{1}{2} \\ \cdot & 3 & \cdot \\ -\frac{1}{2} & \cdot & \frac{9}{2} \end{pmatrix}$$

eigen-values: $(B+C=5, A+B=3, A+C=4)$

eigen-vectors: $\begin{pmatrix} 1/\sqrt{2} & 0 & 1/\sqrt{2} \\ 0 & 1 & 0 \\ -1/\sqrt{2} & 0 & +1/\sqrt{2} \end{pmatrix}$

$$\begin{aligned} |B+C\rangle &= 1/\sqrt{2} |1_{m,+1}\rangle & -1/\sqrt{2} |1_{m,-1}\rangle & \text{y-like} \\ |A+B\rangle &= & + |1_{m,0}\rangle & \\ |A+C\rangle &= 1/\sqrt{2} |1_{m,+1}\rangle & + 1/\sqrt{2} |1_{m,-1}\rangle & \text{x-like} \end{aligned}$$

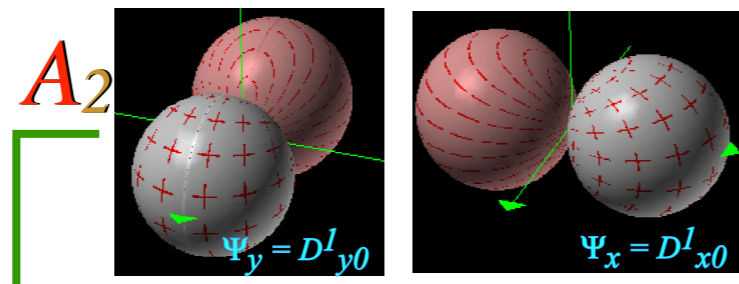
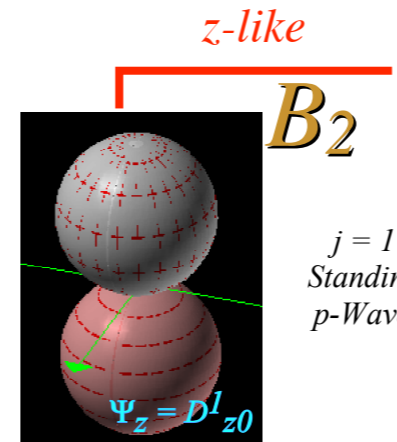

Body-based $J=1$
vector-like eigenfunctions

D_2	1	R_x	R_y	R_z
A_1	1	1	1	1
A_2	1	-1	1	-1
B_1	1	1	-1	-1
B_2	1	-1	-1	1

Review :

*Symmetric rigid quantum rotor analysis of $R(2)$ Hamiltonian $\mathbf{H} = B\mathbf{J}_x^2 + B\mathbf{J}_y^2 + C\mathbf{J}_z^2$
Rotational Energy Surfaces (RE or RES) and $R(3) \sim U(2)$ representations*

Asymmetric rigid quantum rotor analysis of D_2 Hamiltonian $\mathbf{H} = A\mathbf{J}_x^2 + B\mathbf{J}_y^2 + C\mathbf{J}_z^2$

RES and Multipole \mathbf{T}_q^k tensor expansions

Atomic or molecular $R(3)$ ℓ -level or $2\ell+1$ -multiplet splitting (Review of D_3)

$R(3) \supset D_2$ character analysis of ℓ -level or $2\ell+1$ -multiplet splitting in D_2

Detailed angular momentum operator analysis for $J=1-2$ for D_2 symmetry

Asymmetric rotor levels and RES plots for high- J

Octahedral semi-rigid quantum rotor analysis of O_h Hamiltonian $\mathbf{H} = B\mathbf{J} \cdot \mathbf{J} + t_{044}\mathbf{T}^{[4]}$

Spherical rotor levels and RES plots of O_h tensor eigenvalues

$R(3) \subset O(3) \supset O_h \supset O$ character analysis of ℓ -level or $2\ell+1$ -multiplet splitting in O

SF_6 spectral fine structure

CF_4 spectral fine structure

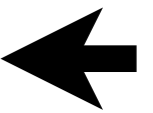
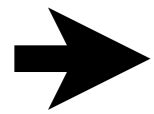

$(J=2)$ -Matrix for $A=1, B=2, C=3$.

$$\langle A\mathbf{J}_1^2 + B\mathbf{J}_2^2 + C\mathbf{J}_3^2 \rangle^{J=2} = \begin{pmatrix} (A+B)+4C & \cdot & \frac{\sqrt{6}}{2}(A-B) & \cdot & \cdot \\ \cdot & \frac{5}{2}(A+B)+C & \cdot & \frac{3}{2}(A-B) & \cdot \\ \frac{\sqrt{6}}{2}(A-B) & \cdot & 3(A+B) & \cdot & \frac{\sqrt{6}}{2}(A-B) \\ \cdot & \frac{3}{2}(A-B) & \cdot & \frac{5}{2}(A+B)+C & \cdot \\ \cdot & \cdot & \frac{\sqrt{6}}{2}(A-B) & \cdot & (A+B)+4C \end{pmatrix} = \begin{pmatrix} 15 & \cdot & -\frac{\sqrt{6}}{2} & \cdot & \cdot \\ \cdot & \frac{15}{2} & \cdot & -\frac{3}{2} & \cdot \\ -\frac{\sqrt{6}}{2} & \cdot & 6 & \cdot & -\frac{\sqrt{6}}{2} \\ \cdot & -\frac{3}{2} & \cdot & \frac{15}{2} & \cdot \\ \cdot & \cdot & -\frac{\sqrt{6}}{2} & \cdot & 15 \end{pmatrix}$$

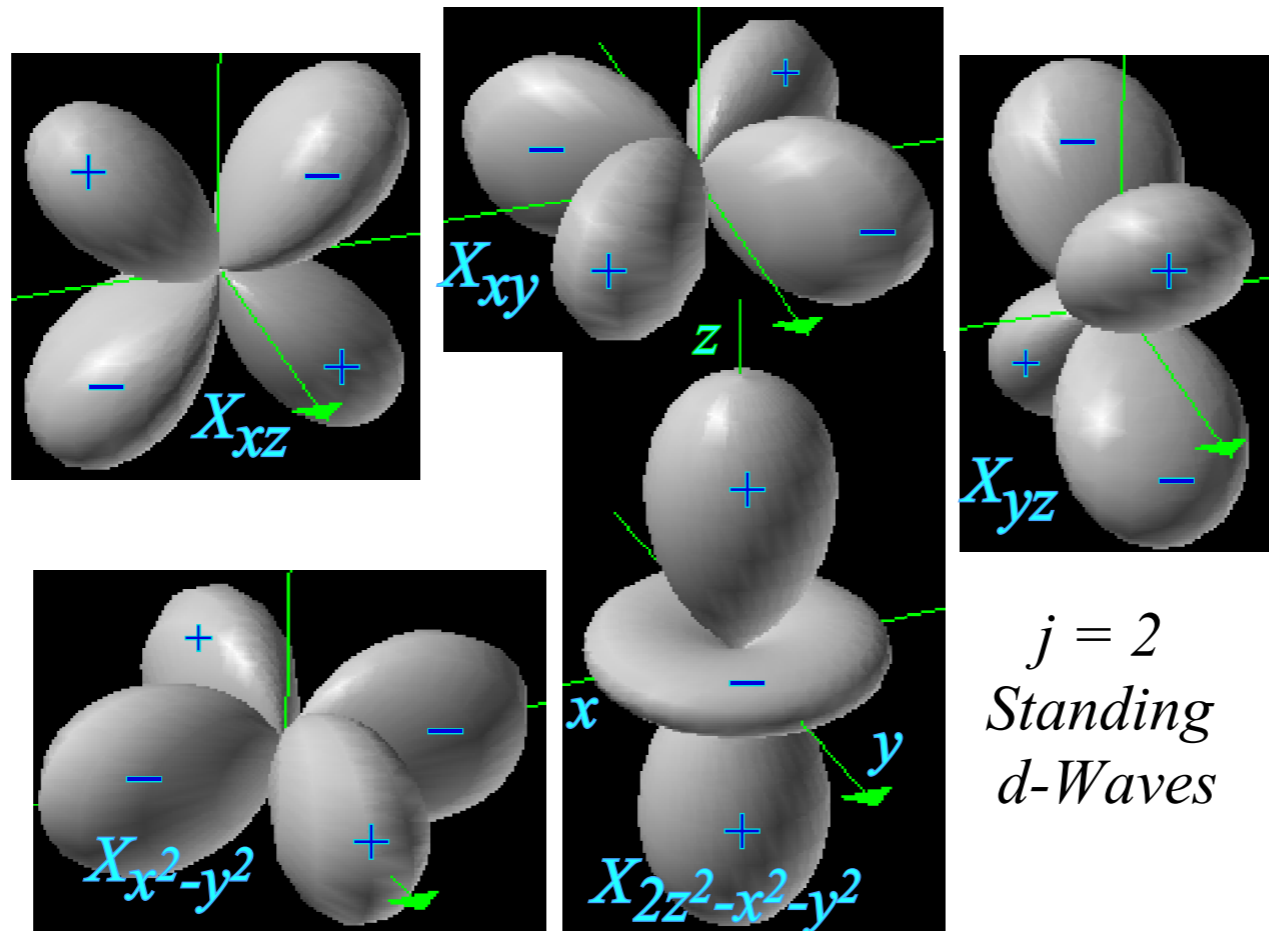

$f^{(\alpha)}(\ell)$	f^{A_1}	f^{A_2}	f^{B_1}	f^{B_2}
$\ell = 0$	1	·	·	
1	·	1	1	1
2	2	1	1	1
3	1	2	2	2
4	3	2	2	2
5	2	3	3	3
6	4	3	3	3
7	3	4	4	4

$(J=2)$ -Matrix for $A=1, B=2, C=3$.

$$\langle A\mathbf{J}_1^2 + B\mathbf{J}_2^2 + C\mathbf{J}_3^2 \rangle^{J=2} = \begin{pmatrix} (A+B)+4C & \cdot & \frac{\sqrt{6}}{2}(A-B) & \cdot & \cdot \\ \cdot & \frac{5}{2}(A+B)+C & \cdot & \frac{3}{2}(A-B) & \cdot \\ \frac{\sqrt{6}}{2}(A-B) & \cdot & 3(A+B) & \cdot & \frac{\sqrt{6}}{2}(A-B) \\ \cdot & \frac{3}{2}(A-B) & \cdot & \frac{5}{2}(A+B)+C & \cdot \\ \cdot & \cdot & \frac{\sqrt{6}}{2}(A-B) & \cdot & (A+B)+4C \end{pmatrix} = \begin{pmatrix} 15 & \cdot & -\frac{\sqrt{6}}{2} & \cdot & \cdot \\ \cdot & \frac{15}{2} & \cdot & -\frac{3}{2} & \cdot \\ -\frac{\sqrt{6}}{2} & \cdot & 6 & \cdot & -\frac{\sqrt{6}}{2} \\ \cdot & -\frac{3}{2} & \cdot & \frac{15}{2} & \cdot \\ \cdot & \cdot & -\frac{\sqrt{6}}{2} & \cdot & 15 \end{pmatrix}$$

Matrix is nearly diagonalized in standing-wave D_2 -symmetry basis

$$\begin{aligned} |A_1 2^+\rangle &= \frac{1}{\sqrt{2}} \left| \begin{matrix} 2 \\ +2 \end{matrix} \right\rangle + \frac{1}{\sqrt{2}} \left| \begin{matrix} 2 \\ -2 \end{matrix} \right\rangle, & |B_1 1^+\rangle &= \frac{1}{\sqrt{2}} \left| \begin{matrix} 2 \\ +1 \end{matrix} \right\rangle + \frac{1}{\sqrt{2}} \left| \begin{matrix} 2 \\ -1 \end{matrix} \right\rangle, & |A_1 0\rangle &= \left| \begin{matrix} 2 \\ 0 \end{matrix} \right\rangle \\ |B_2 2^-\rangle &= \frac{1}{\sqrt{2}} \left| \begin{matrix} 2 \\ +2 \end{matrix} \right\rangle - \frac{1}{\sqrt{2}} \left| \begin{matrix} 2 \\ -2 \end{matrix} \right\rangle, & |A_2 1^-\rangle &= \frac{1}{\sqrt{2}} \left| \begin{matrix} 2 \\ +1 \end{matrix} \right\rangle - \frac{1}{\sqrt{2}} \left| \begin{matrix} 2 \\ -1 \end{matrix} \right\rangle \end{aligned}$$

$f^{(\alpha)}(\ell)$	f^{A_1}	f^{A_2}	f^{B_1}	f^{B_2}
$\ell = 0$	1	·	·	
1	·	1	1	1
2	2	1	1	1
3	1	2	2	2
4	3	2	2	2
5	2	3	3	3
6	4	3	3	3
7	3	4	4	4

$(J=2)$ -Matrix for $A=1, B=2, C=3$.

$$\langle A\mathbf{J}_1^2 + B\mathbf{J}_2^2 + C\mathbf{J}_3^2 \rangle^{J=2} = \begin{pmatrix} (A+B)+4C & \cdot & \frac{\sqrt{6}}{2}(A-B) & \cdot & \cdot \\ \cdot & \frac{5}{2}(A+B)+C & \cdot & \frac{3}{2}(A-B) & \cdot \\ \frac{\sqrt{6}}{2}(A-B) & \cdot & 3(A+B) & \cdot & \frac{\sqrt{6}}{2}(A-B) \\ \cdot & \frac{3}{2}(A-B) & \cdot & \frac{5}{2}(A+B)+C & \cdot \\ \cdot & \cdot & \frac{\sqrt{6}}{2}(A-B) & \cdot & (A+B)+4C \end{pmatrix} = \begin{pmatrix} 15 & -\frac{\sqrt{6}}{2} & \cdot & \cdot & \cdot \\ \cdot & \frac{15}{2} & \cdot & \frac{-3}{2} & \cdot \\ -\frac{\sqrt{6}}{2} & \cdot & 6 & \cdot & -\frac{\sqrt{6}}{2} \\ \cdot & \frac{-3}{2} & \cdot & \frac{15}{2} & \cdot \\ \cdot & \cdot & -\frac{\sqrt{6}}{2} & \cdot & 15 \end{pmatrix}$$

Matrix is nearly diagonalized in standing-wave D_2 -symmetry basis

$$\begin{aligned} |A_1 2^+\rangle &= \frac{1}{\sqrt{2}} \left| \begin{matrix} 2 \\ +2 \end{matrix} \right\rangle + \frac{1}{\sqrt{2}} \left| \begin{matrix} 2 \\ -2 \end{matrix} \right\rangle, & |B_1 1^+\rangle &= \frac{1}{\sqrt{2}} \left| \begin{matrix} 2 \\ +1 \end{matrix} \right\rangle + \frac{1}{\sqrt{2}} \left| \begin{matrix} 2 \\ -1 \end{matrix} \right\rangle, & |A_1 0\rangle &= \left| \begin{matrix} 2 \\ 0 \end{matrix} \right\rangle \\ |B_2 2^-\rangle &= \frac{1}{\sqrt{2}} \left| \begin{matrix} 2 \\ +2 \end{matrix} \right\rangle - \frac{1}{\sqrt{2}} \left| \begin{matrix} 2 \\ -2 \end{matrix} \right\rangle, & |A_2 1^-\rangle &= \frac{1}{\sqrt{2}} \left| \begin{matrix} 2 \\ +1 \end{matrix} \right\rangle - \frac{1}{\sqrt{2}} \left| \begin{matrix} 2 \\ -1 \end{matrix} \right\rangle \end{aligned}$$

The following basis transformation “almost diagonalizes” $\langle \mathbf{H} \rangle^{J=2}$ by reducing it to block form.

Let: $\Sigma = A + B$ and $\Delta = A - B$ to shorten expressions.

$$\begin{aligned} & \begin{pmatrix} 1 & \cdot & \cdot & \cdot & 1 \\ 1 & \cdot & \cdot & \cdot & -1 \\ \cdot & 1 & \cdot & 1 & \cdot \\ \cdot & 1 & \cdot & -1 & \cdot \\ \cdot & \cdot & \sqrt{2} & \cdot & \cdot \end{pmatrix} \begin{pmatrix} 4C - \Sigma & \cdot & \frac{\sqrt{6}\Delta}{2} & \cdot & \cdot \\ \cdot & C + \frac{\Sigma}{2} & \cdot & \frac{3\Delta}{2} & \cdot \\ \frac{\sqrt{6}\Delta}{2} & \cdot & \Sigma & \cdot & \frac{\sqrt{6}\Delta}{2} \\ \cdot & \frac{3\Delta}{2} & \cdot & C + \frac{\Sigma}{2} & \cdot \\ \cdot & \cdot & \frac{\sqrt{6}\Delta}{2} & \cdot & 4C - \Sigma \end{pmatrix} \begin{pmatrix} 1 & 1 & \cdot & \cdot & \cdot \\ \cdot & \cdot & 1 & 1 & \cdot \\ \cdot & \cdot & \cdot & \cdot & \sqrt{2} \\ \cdot & \cdot & 1 & -1 & \cdot \\ 1 & -1 & \cdot & \cdot & \cdot \end{pmatrix} \begin{pmatrix} 1 \\ \cdot \\ \cdot \\ \cdot \\ \cdot \end{pmatrix} + 2\Sigma \mathbf{1} \\ & = \begin{pmatrix} 4C + \Sigma & \cdot & \cdot & \cdot & \sqrt{3}\Delta \\ \cdot & 4C + \Sigma & \cdot & \cdot & \cdot \\ \cdot & \cdot & C + \frac{5\Sigma}{2} + \frac{3\Delta}{2} & \cdot & \cdot \\ \cdot & \cdot & \cdot & C + \frac{5\Sigma}{2} - \frac{3\Delta}{2} & \cdot \\ \sqrt{3}\Delta & \cdot & \cdot & \cdot & 3\Sigma \end{pmatrix} = \begin{pmatrix} 4C + A + B & \cdot & \cdot & \cdot & \sqrt{3}(A - B) \\ \cdot & 4C + A + B & \cdot & \cdot & \cdot \\ \cdot & \cdot & C + 4A + B & \cdot & \cdot \\ \cdot & \cdot & \cdot & C + A + 4B & \cdot \\ \sqrt{3}(A - B) & \cdot & \cdot & \cdot & 3A + 3B \end{pmatrix} \end{aligned}$$

New D_2 basis:

$$\begin{aligned} |A_1 2^+\rangle &= \frac{1}{\sqrt{2}} \left| \begin{matrix} 2 \\ +2 \end{matrix} \right\rangle + \frac{1}{\sqrt{2}} \left| \begin{matrix} 2 \\ -2 \end{matrix} \right\rangle \\ |B_2 2^-\rangle &= \frac{1}{\sqrt{2}} \left| \begin{matrix} 2 \\ +2 \end{matrix} \right\rangle - \frac{1}{\sqrt{2}} \left| \begin{matrix} 2 \\ -2 \end{matrix} \right\rangle \\ |B_1 1^+\rangle &= \frac{1}{\sqrt{2}} \left| \begin{matrix} 2 \\ +1 \end{matrix} \right\rangle + \frac{1}{\sqrt{2}} \left| \begin{matrix} 2 \\ -1 \end{matrix} \right\rangle \\ |A_2 1^-\rangle &= \frac{1}{\sqrt{2}} \left| \begin{matrix} 2 \\ +1 \end{matrix} \right\rangle - \frac{1}{\sqrt{2}} \left| \begin{matrix} 2 \\ -1 \end{matrix} \right\rangle \\ |A_1 0\rangle &= \left| \begin{matrix} 2 \\ 0 \end{matrix} \right\rangle \end{aligned}$$

Completing diagonalization from new D_2 basis:

$$\begin{pmatrix} 4C + A + B & \cdot & \cdot & \cdot & \sqrt{3}(A - B) \\ \cdot & 4C + A + B & \cdot & \cdot & \cdot \\ \cdot & \cdot & C + 4A + B & \cdot & \cdot \\ \cdot & \cdot & \cdot & C + A + 4B & \cdot \\ \sqrt{3}(A - B) & \cdot & \cdot & \cdot & 3A + 3B \end{pmatrix}$$

D_2	$\mathbf{1}$	\mathbf{R}_x	\mathbf{R}_y	\mathbf{R}_z
A_1	1	1	1	1
A_2	1	-1	1	-1
B_1	1	1	-1	-1
B_2	1	-1	-1	1

$$C_2^x \begin{matrix} \mathbf{1} & \mathbf{R}_x \\ + & 1 & 1 \\ - & 1 & -1 \end{matrix} \times C_2^y \begin{matrix} \mathbf{1} & \mathbf{R}_y \\ + & 1 & 1 \\ - & 1 & -1 \end{matrix}$$

$$= C_2^x \times C_2^y \begin{matrix} \mathbf{1} \cdot \mathbf{1} & \mathbf{R}_x \cdot \mathbf{1} & \mathbf{1} \cdot \mathbf{R}_y & \mathbf{R}_x \cdot \mathbf{R}_y \\ + \cdot + & 1 \cdot 1 & 1 \cdot 1 & 1 \cdot 1 \\ - \cdot + & 1 \cdot 1 & 1 \cdot 1 & 1 \cdot 1 \\ + \cdot - & 1 \cdot 1 & 1 \cdot (-1) & 1 \cdot (-1) \\ - \cdot - & 1 \cdot 1 & 1 \cdot (-1) & 1 \cdot (-1) \end{matrix}$$

D_2	$\mathbf{1}$	\mathbf{R}_x	\mathbf{R}_y	\mathbf{R}_z
$+ \cdot + = A_1$	1	1	1	1
$- \cdot + = A_2$	1	-1	1	-1
$+ \cdot - = B_1$	1	1	-1	-1
$- \cdot - = B_2$	1	-1	-1	1

$$|A_1 2^+\rangle = \frac{1}{\sqrt{2}} \left| \begin{matrix} 2 \\ +2 \end{matrix} \right\rangle + \frac{1}{\sqrt{2}} \left| \begin{matrix} 2 \\ -2 \end{matrix} \right\rangle$$

$$|B_2 2^-\rangle = \frac{1}{\sqrt{2}} \left| \begin{matrix} 2 \\ +2 \end{matrix} \right\rangle - \frac{1}{\sqrt{2}} \left| \begin{matrix} 2 \\ -2 \end{matrix} \right\rangle$$

$$|B_1 1^+\rangle = \frac{1}{\sqrt{2}} \left| \begin{matrix} 2 \\ +1 \end{matrix} \right\rangle + \frac{1}{\sqrt{2}} \left| \begin{matrix} 2 \\ -1 \end{matrix} \right\rangle$$

$$|A_2 1^-\rangle = \frac{1}{\sqrt{2}} \left| \begin{matrix} 2 \\ +1 \end{matrix} \right\rangle - \frac{1}{\sqrt{2}} \left| \begin{matrix} 2 \\ -1 \end{matrix} \right\rangle$$

$$|A_1 0\rangle = \left| \begin{matrix} 2 \\ 0 \end{matrix} \right\rangle$$

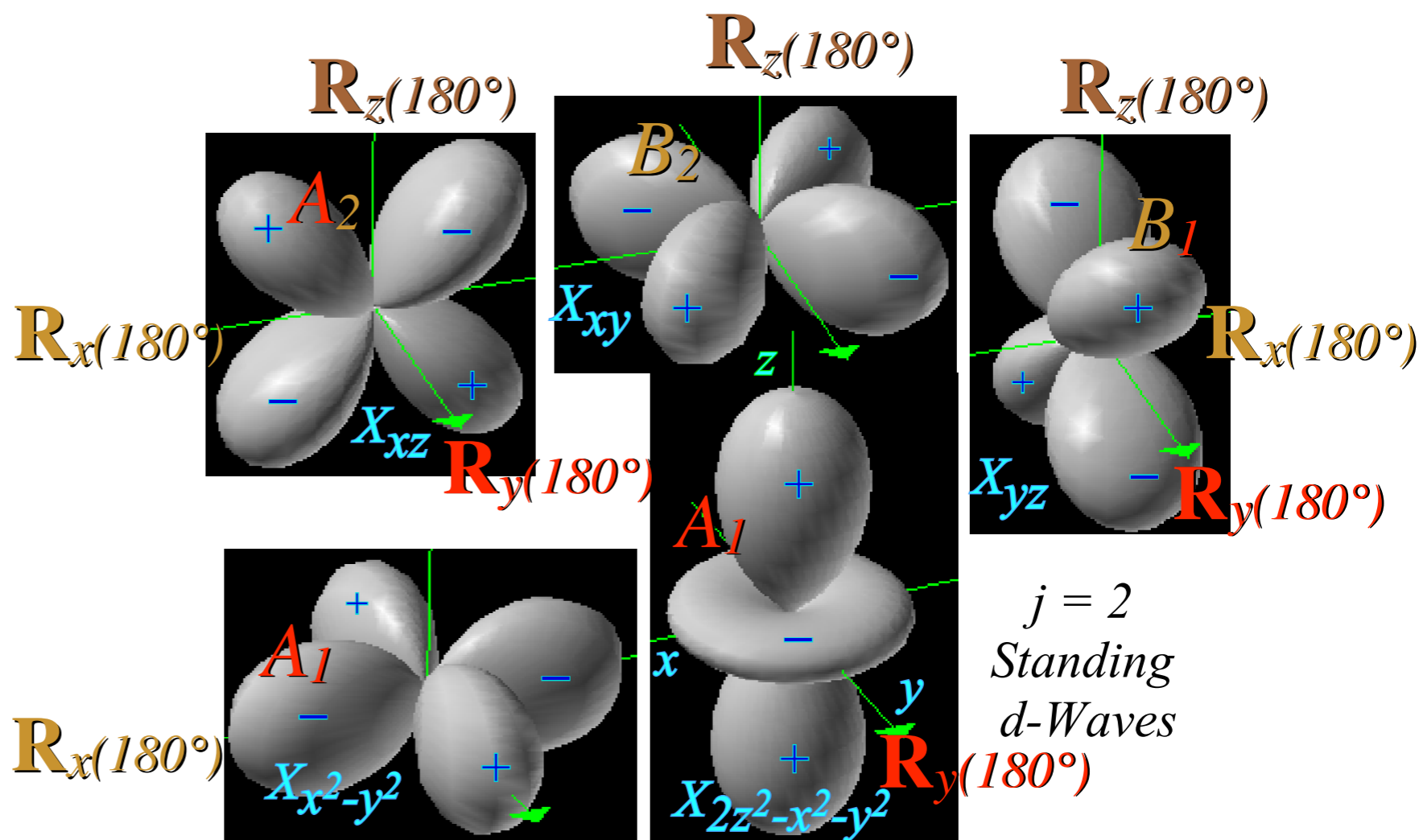

Completing diagonalization from new D_2 basis:

$$\begin{pmatrix} 4C + A + B & \cdot & \cdot & \cdot & \sqrt{3}(A - B) \\ \cdot & 4C + A + B & \cdot & \cdot & \cdot \\ \cdot & \cdot & C + 4A + B & \cdot & \cdot \\ \cdot & \cdot & \cdot & C + A + 4B & \cdot \\ \sqrt{3}(A - B) & \cdot & \cdot & \cdot & 3A + 3B \end{pmatrix} \begin{array}{l} |A_1 2^+\rangle = \frac{1}{\sqrt{2}} |^2_{+2}\rangle + \frac{1}{\sqrt{2}} |^2_{-2}\rangle \\ |B_2 2^-\rangle = \frac{1}{\sqrt{2}} |^2_{+2}\rangle - \frac{1}{\sqrt{2}} |^2_{-2}\rangle \\ |B_1 1^+\rangle = \frac{1}{\sqrt{2}} |^2_{+1}\rangle + \frac{1}{\sqrt{2}} |^2_{-1}\rangle \\ |A_2 1^-\rangle = \frac{1}{\sqrt{2}} |^2_{+1}\rangle - \frac{1}{\sqrt{2}} |^2_{-1}\rangle \\ |A_1 0\rangle = |^2_0\rangle \end{array}$$

D_2	$\mathbf{1}$	\mathbf{R}_x	\mathbf{R}_y	\mathbf{R}_z
A_1	1	1	1	1
A_2	1	-1	1	-1
B_1	1	1	-1	-1
B_2	1	-1	-1	1

Need only diagonalize the two A_1 's:

(It is $n=0$ versus $n=2^+$)

$$\begin{pmatrix} 4C + A + B & \sqrt{3}(A - B) \\ \sqrt{3}(A - B) & 3A + 3B \end{pmatrix} \begin{array}{l} |A_1 2^+\rangle = \frac{1}{\sqrt{2}} |^2_{+2}\rangle + \frac{1}{\sqrt{2}} |^2_{-2}\rangle \\ |A_1 0\rangle = |^2_0\rangle \end{array}$$

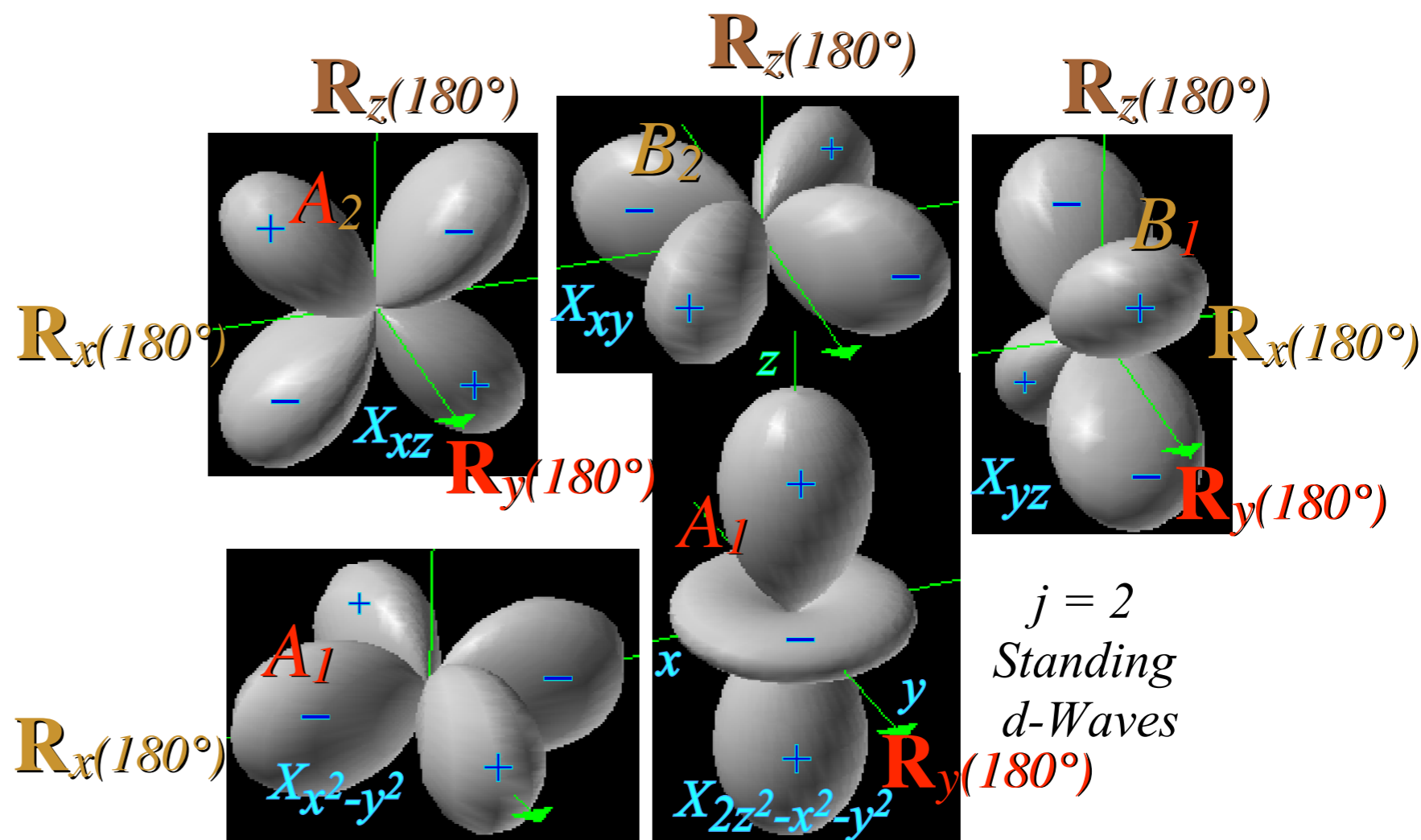

$j = 2$
Standing
d-Waves

Completing diagonalization from new D_2 basis:

$$\begin{pmatrix} 4C + A + B & \cdot & \cdot & \cdot & \sqrt{3}(A - B) \\ \cdot & 4C + A + B & \cdot & \cdot & \cdot \\ \cdot & \cdot & C + 4A + B & \cdot & \cdot \\ \cdot & \cdot & \cdot & C + A + 4B & \cdot \\ \sqrt{3}(A - B) & \cdot & \cdot & \cdot & 3A + 3B \end{pmatrix}$$

$$\begin{aligned} |A_1 2^+\rangle &= \frac{1}{\sqrt{2}} \left| \begin{matrix} 2 \\ +2 \end{matrix} \right\rangle + \frac{1}{\sqrt{2}} \left| \begin{matrix} 2 \\ -2 \end{matrix} \right\rangle \\ |B_2 2^-\rangle &= \frac{1}{\sqrt{2}} \left| \begin{matrix} 2 \\ +2 \end{matrix} \right\rangle - \frac{1}{\sqrt{2}} \left| \begin{matrix} 2 \\ -2 \end{matrix} \right\rangle \\ |B_1 1^+\rangle &= \frac{1}{\sqrt{2}} \left| \begin{matrix} 2 \\ +1 \end{matrix} \right\rangle + \frac{1}{\sqrt{2}} \left| \begin{matrix} 2 \\ -1 \end{matrix} \right\rangle \\ |A_2 1^-\rangle &= \frac{1}{\sqrt{2}} \left| \begin{matrix} 2 \\ +1 \end{matrix} \right\rangle - \frac{1}{\sqrt{2}} \left| \begin{matrix} 2 \\ -1 \end{matrix} \right\rangle \\ |A_1 0\rangle &= \left| \begin{matrix} 2 \\ 0 \end{matrix} \right\rangle \end{aligned}$$

Need only diagonalize the two A_1 's:

(It is $n=0$ versus $n=2^+$)

$$\begin{pmatrix} 4C + A + B & \sqrt{3}(A - B) \\ \sqrt{3}(A - B) & 3A + 3B \end{pmatrix} \begin{matrix} |A_1 2^+\rangle = \frac{1}{\sqrt{2}} \left| \begin{matrix} 2 \\ +2 \end{matrix} \right\rangle + \frac{1}{\sqrt{2}} \left| \begin{matrix} 2 \\ -2 \end{matrix} \right\rangle \\ |A_1 0\rangle = \left| \begin{matrix} 2 \\ 0 \end{matrix} \right\rangle \end{matrix}$$

$$= (2C + 2A + 2B) \cdot \mathbf{1} + \begin{pmatrix} 2C - A - B & \sqrt{3}(A - B) \\ \sqrt{3}(A - B) & -(2C - A - B) \end{pmatrix}$$

D_2	$\mathbf{1}$	\mathbf{R}_x	\mathbf{R}_y	\mathbf{R}_z
A_1	1	1	1	1
A_2	1	-1	1	-1
B_1	1	1	-1	-1
B_2	1	-1	-1	1

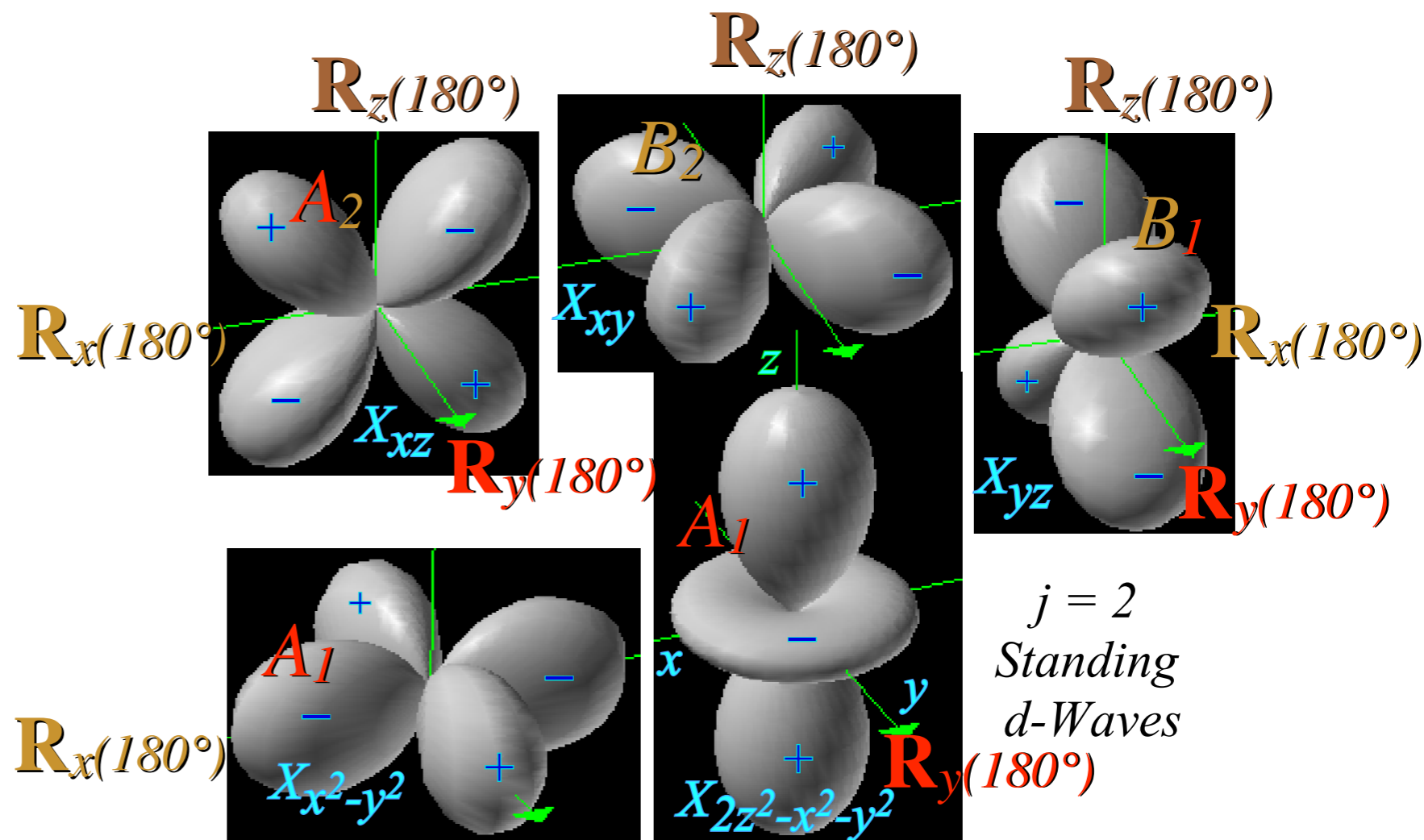

Completing diagonalization from new D_2 basis:

$$\begin{pmatrix} 4C + A + B & \cdot & \cdot & \cdot & \sqrt{3}(A - B) \\ \cdot & 4C + A + B & \cdot & \cdot & \cdot \\ \cdot & \cdot & C + 4A + B & \cdot & \cdot \\ \cdot & \cdot & \cdot & C + A + 4B & \cdot \\ \sqrt{3}(A - B) & \cdot & \cdot & \cdot & 3A + 3B \end{pmatrix}$$

$$\begin{aligned} |A_1 2^+\rangle &= \frac{1}{\sqrt{2}} \left| \begin{matrix} 2 \\ +2 \end{matrix} \right\rangle + \frac{1}{\sqrt{2}} \left| \begin{matrix} 2 \\ -2 \end{matrix} \right\rangle \\ |B_2 2^-\rangle &= \frac{1}{\sqrt{2}} \left| \begin{matrix} 2 \\ +2 \end{matrix} \right\rangle - \frac{1}{\sqrt{2}} \left| \begin{matrix} 2 \\ -2 \end{matrix} \right\rangle \\ |B_1 1^+\rangle &= \frac{1}{\sqrt{2}} \left| \begin{matrix} 2 \\ +1 \end{matrix} \right\rangle + \frac{1}{\sqrt{2}} \left| \begin{matrix} 2 \\ -1 \end{matrix} \right\rangle \\ |A_2 1^-\rangle &= \frac{1}{\sqrt{2}} \left| \begin{matrix} 2 \\ +1 \end{matrix} \right\rangle - \frac{1}{\sqrt{2}} \left| \begin{matrix} 2 \\ -1 \end{matrix} \right\rangle \\ |A_1 0\rangle &= \left| \begin{matrix} 2 \\ 0 \end{matrix} \right\rangle \end{aligned}$$

Need only diagonalize the two A_1 's:

(It is $n=0$ versus $n=2^+$)

$$\begin{pmatrix} 4C + A + B & \sqrt{3}(A - B) \\ \sqrt{3}(A - B) & 3A + 3B \end{pmatrix} \begin{pmatrix} |A_1 2^+\rangle \\ |A_1 0\rangle \end{pmatrix} = \begin{pmatrix} \frac{1}{\sqrt{2}} \left| \begin{matrix} 2 \\ +2 \end{matrix} \right\rangle + \frac{1}{\sqrt{2}} \left| \begin{matrix} 2 \\ -2 \end{matrix} \right\rangle \\ \left| \begin{matrix} 2 \\ 0 \end{matrix} \right\rangle \end{pmatrix}$$

$$= (2C + 2A + 2B) \cdot \mathbf{1} + \begin{pmatrix} 2C - A - B & \sqrt{3}(A - B) \\ \sqrt{3}(A - B) & -(2C - A - B) \end{pmatrix}$$

$J=2$ Levels of prolate vs. oblate cases with eigenvalues:

$$\begin{aligned} \lambda_{\pm} &= 2C + 2A + 2B \pm \sqrt{(2C - A - B)^2 + 3(A - B)^2} \\ &= 2(A + B + C) \pm 2\sqrt{C^2 - (A + B)C + A^2 - AB + B^2} \\ &= 2C + 4B \pm 2(C - B) = \begin{cases} 4C + 2B & \text{if } A = B \\ 6B & \end{cases} \end{aligned}$$

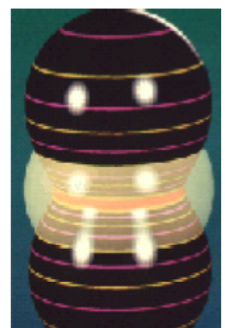

prolate

($A=2, B=2, C=3$)

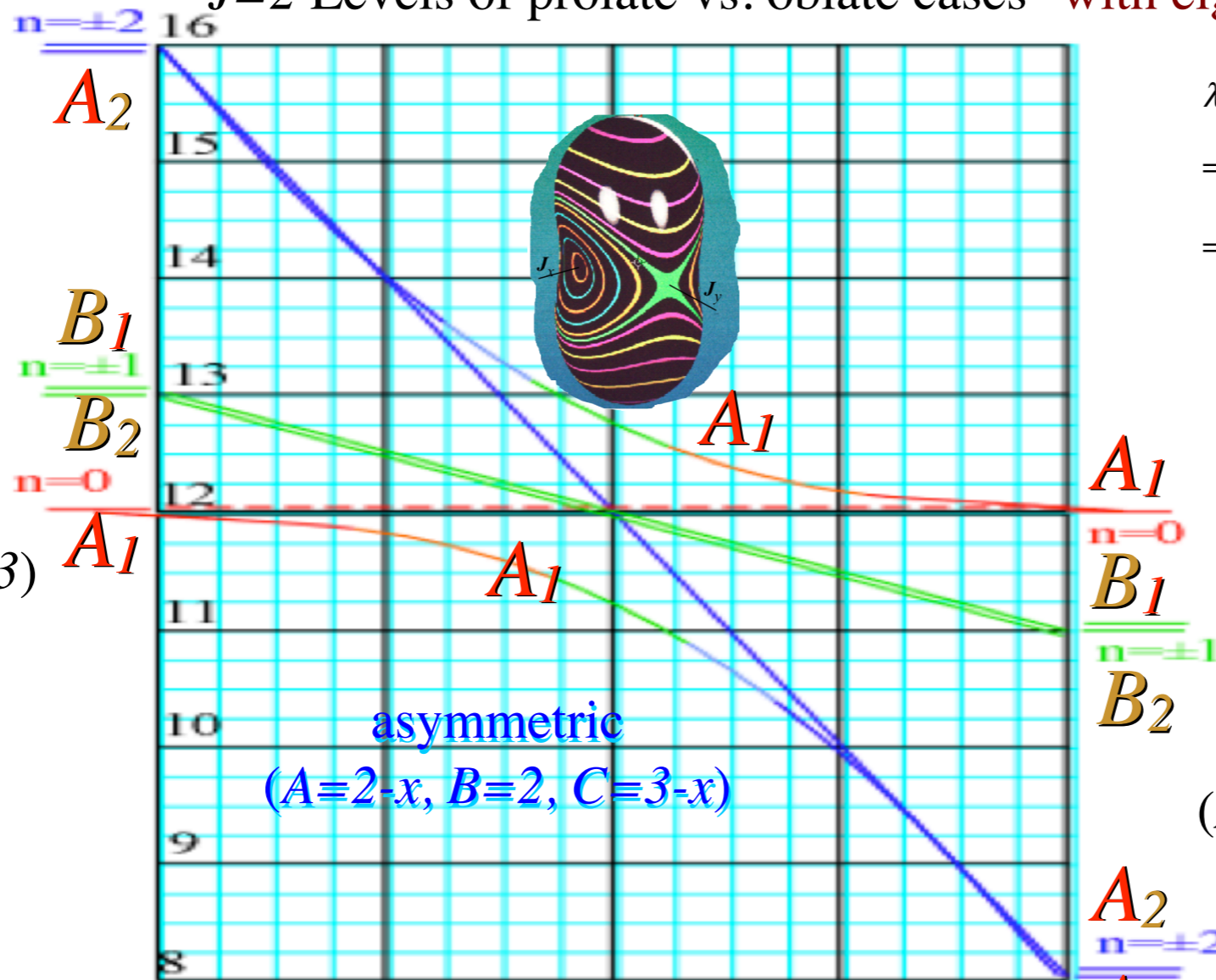

asymmetric
($A=2-x, B=2, C=3-x$)

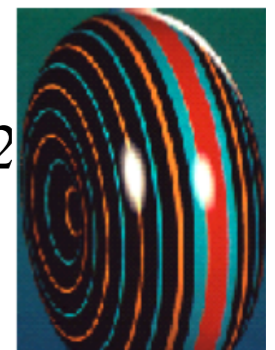

oblate

($A=1, B=2, C=2$)

$A=B$ prolate case: ($A=2=B=2, C=3$)

$B(J(J+1) + (C-B)n^2) = 2B + 4C = 4 + 12 = 16$ ($n=\pm 2$)

$5B + C = 10 + 3 = 13$ ($n=\pm 1$), $6B = 12$ ($n=0$)

$B=C$ oblate case: ($A=1, B=2=C=2$)

$B(J(J+1) + (A-B)n^2) = 2B + 4A = 4 + 4 = 8$ ($n=\pm 2$)

$5B + A = 10 + 1 = 11$ ($n=\pm 1$), $6B = 12$ ($n=0$)

Completing diagonalization from new D_2 basis:

$$\begin{pmatrix} 4C + A + B & \cdot & \cdot & \cdot & \sqrt{3}(A - B) \\ \cdot & 4C + A + B & \cdot & \cdot & \cdot \\ \cdot & \cdot & C + 4A + B & \cdot & \cdot \\ \cdot & \cdot & \cdot & C + A + 4B & \cdot \\ \sqrt{3}(A - B) & \cdot & \cdot & \cdot & 3A + 3B \end{pmatrix}$$

$$\begin{aligned} |A_1 2^+\rangle &= \frac{1}{\sqrt{2}} \left| \begin{matrix} 2 \\ +2 \end{matrix} \right\rangle + \frac{1}{\sqrt{2}} \left| \begin{matrix} 2 \\ -2 \end{matrix} \right\rangle \\ |B_2 2^-\rangle &= \frac{1}{\sqrt{2}} \left| \begin{matrix} 2 \\ +2 \end{matrix} \right\rangle - \frac{1}{\sqrt{2}} \left| \begin{matrix} 2 \\ -2 \end{matrix} \right\rangle \\ |B_1 1^+\rangle &= \frac{1}{\sqrt{2}} \left| \begin{matrix} 2 \\ +1 \end{matrix} \right\rangle + \frac{1}{\sqrt{2}} \left| \begin{matrix} 2 \\ -1 \end{matrix} \right\rangle \\ |A_2 1^-\rangle &= \frac{1}{\sqrt{2}} \left| \begin{matrix} 2 \\ +1 \end{matrix} \right\rangle - \frac{1}{\sqrt{2}} \left| \begin{matrix} 2 \\ -1 \end{matrix} \right\rangle \\ |A_1 0\rangle &= \left| \begin{matrix} 2 \\ 0 \end{matrix} \right\rangle \end{aligned}$$

Need only diagonalize the two A_1 's:

(It is $n=0$ versus $n=2^+$)

$$\begin{pmatrix} 4C + A + B & \sqrt{3}(A - B) \\ \sqrt{3}(A - B) & 3A + 3B \end{pmatrix} \begin{matrix} |A_1 2^+\rangle = \frac{1}{\sqrt{2}} \left| \begin{matrix} 2 \\ +2 \end{matrix} \right\rangle + \frac{1}{\sqrt{2}} \left| \begin{matrix} 2 \\ -2 \end{matrix} \right\rangle \\ |A_1 0\rangle = \left| \begin{matrix} 2 \\ 0 \end{matrix} \right\rangle \end{matrix}$$

$$= (2C + 2A + 2B) \cdot \mathbf{1} + \begin{pmatrix} 2C - A - B & \sqrt{3}(A - B) \\ \sqrt{3}(A - B) & -(2C - A - B) \end{pmatrix}$$

A_1 $J=2$ Levels of prolate vs. oblate cases with eigenvalues:



prolate

($A=2, B=2, C=3$)

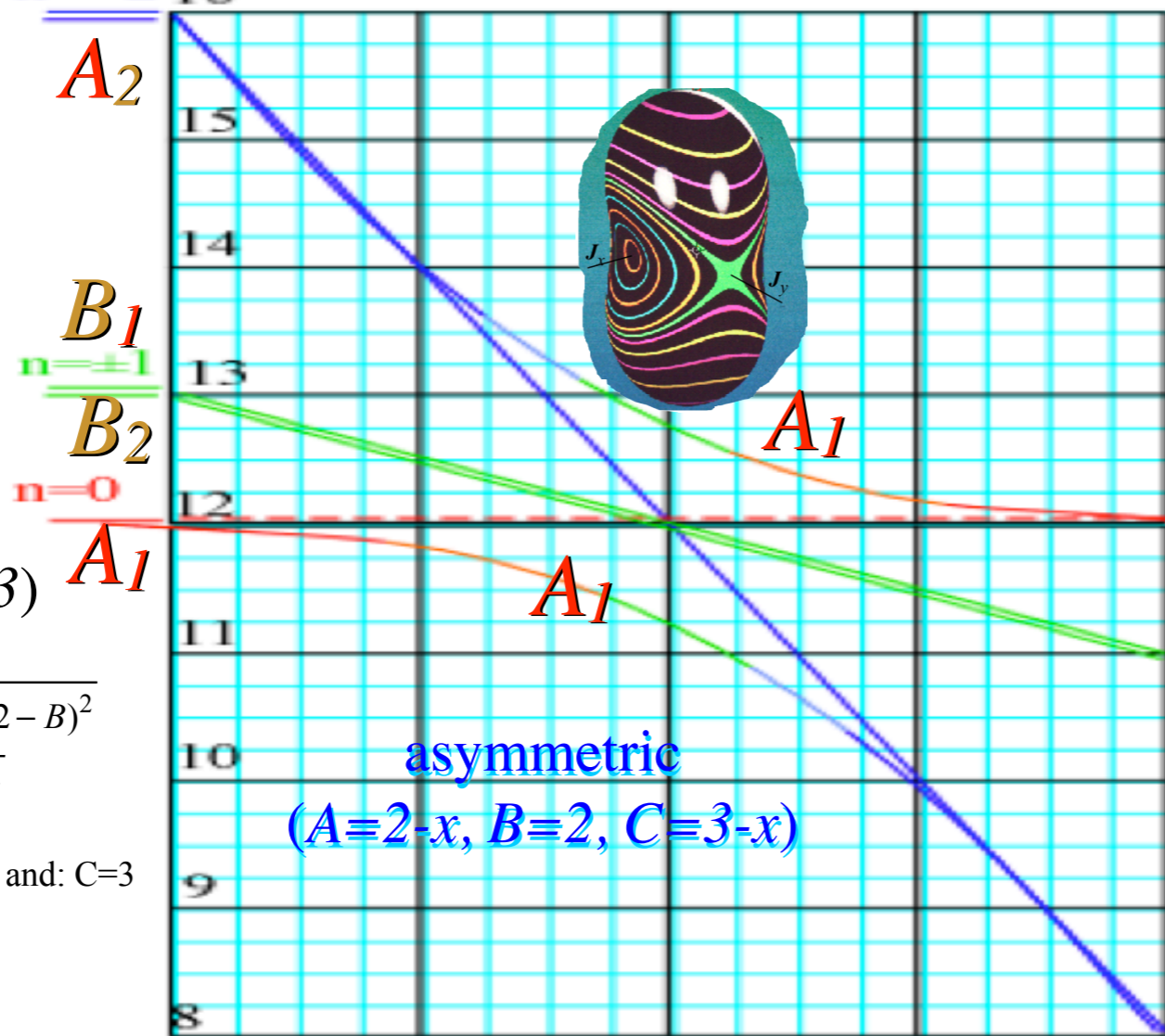

asymmetric

($A=2-x, B=2, C=3-x$)

$$\begin{pmatrix} 14 + B & \sqrt{3}(2 - B) \\ \sqrt{3}(2 - B) & 6 + 3B \end{pmatrix} =$$

$$(10 + 2B) \cdot \mathbf{1} + \begin{pmatrix} 4 - B & \sqrt{3}(2 - B) \\ \sqrt{3}(2 - B) & -(4 - B) \end{pmatrix}$$

oblate
($A=1, B=2, C=2$)

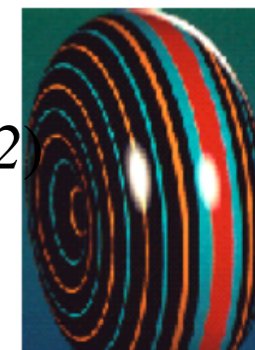

$A=B$ prolate case: ($A=2, B=2, C=3$)

$$B(J(J+1) + (C-B)n^2) = 2B + 4C = 4 + 12 = 16 \quad (n=\pm 2)$$

$$5B + C = 10 + 3 = 13 \quad (n=\pm 1), \quad 6B = 12 \quad (n=0)$$

$B=C$ oblate case: ($A=1, B=2, C=2$)

$$B(J(J+1) + (A-B)n^2) = 2B + 4A = 4 + 4 = 8 \quad (n=\pm 2)$$

$$5B + A = 10 + 1 = 11 \quad (n=\pm 1), \quad 6B = 12 \quad (n=0)$$

Review :

*Symmetric rigid quantum rotor analysis of $R(2)$ Hamiltonian $\mathbf{H} = B\mathbf{J}_x^2 + B\mathbf{J}_y^2 + C\mathbf{J}_z^2$
Rotational Energy Surfaces (RE or RES) and $R(3) \sim U(2)$ representations*

Asymmetric rigid quantum rotor analysis of D_2 Hamiltonian $\mathbf{H} = A\mathbf{J}_x^2 + B\mathbf{J}_y^2 + C\mathbf{J}_z^2$

RES and Multipole \mathbf{T}_q^k tensor expansions

Atomic or molecular $R(3)$ ℓ -level or $2\ell+1$ -multiplet splitting (Review of D_3)

$R(3) \supset D_2$ character analysis of ℓ -level or $2\ell+1$ -multiplet splitting in D_2

Detailed angular momentum operator analysis for $J=1-2$ for D_2 symmetry

Asymmetric rotor levels and RES plots for high- J

Octahedral semi-rigid quantum rotor analysis of O_h Hamiltonian $\mathbf{H} = B\mathbf{J} \cdot \mathbf{J} + t_{044}\mathbf{T}^{[4]}$

Spherical rotor levels and RES plots of O_h tensor eigenvalues

$R(3) \subset O(3) \supset O_h \supset O$ character analysis of ℓ -level or $2\ell+1$ -multiplet splitting in O

SF_6 spectral fine structure

CF_4 spectral fine structure

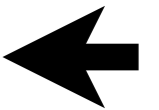
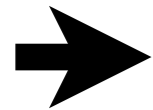

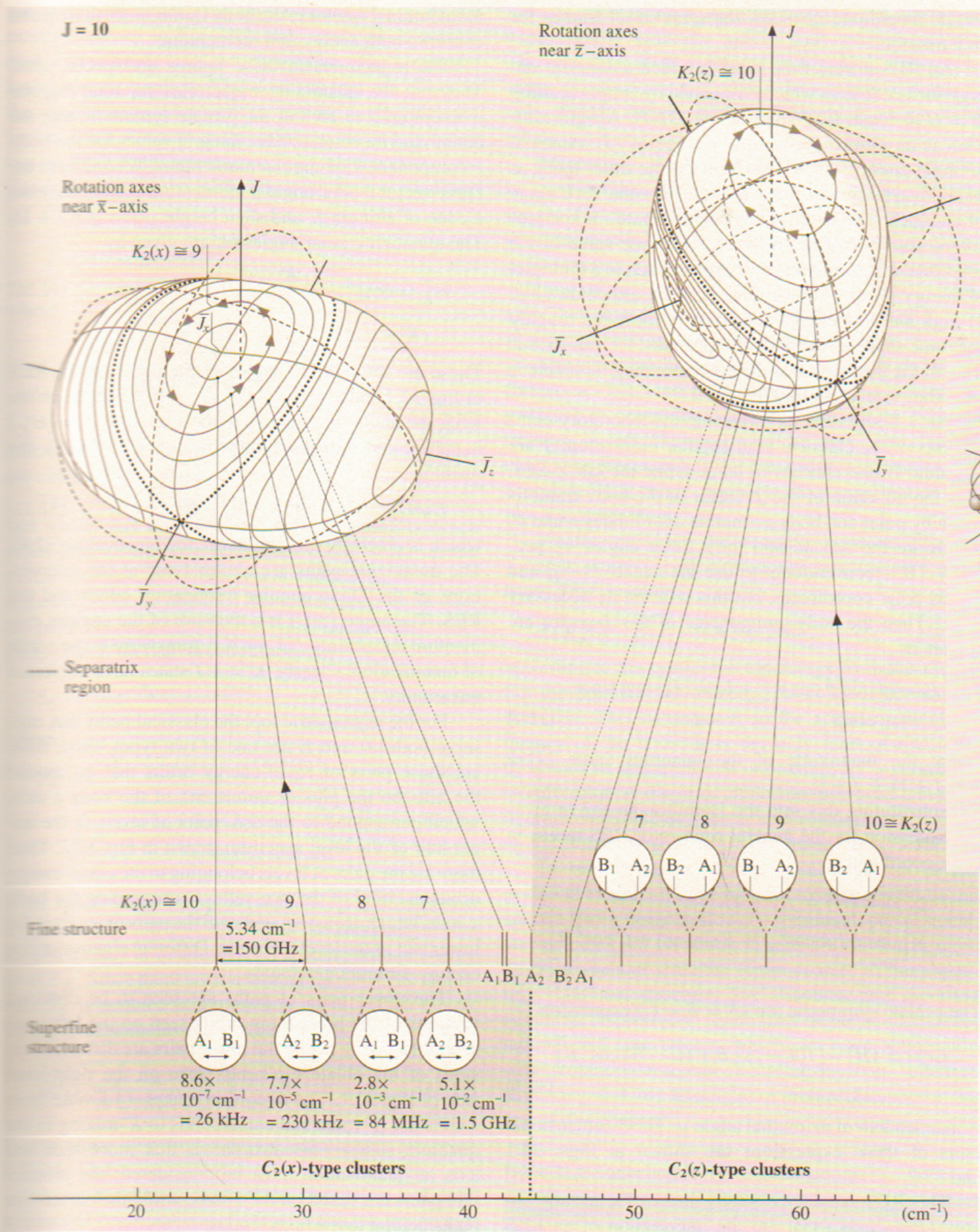

Examples of Group \supset Sub-group correlation
 $D_2 \supset C_2(x)$ $D_2 \supset C_2(y)$ $D_2 \supset C_2(z)$

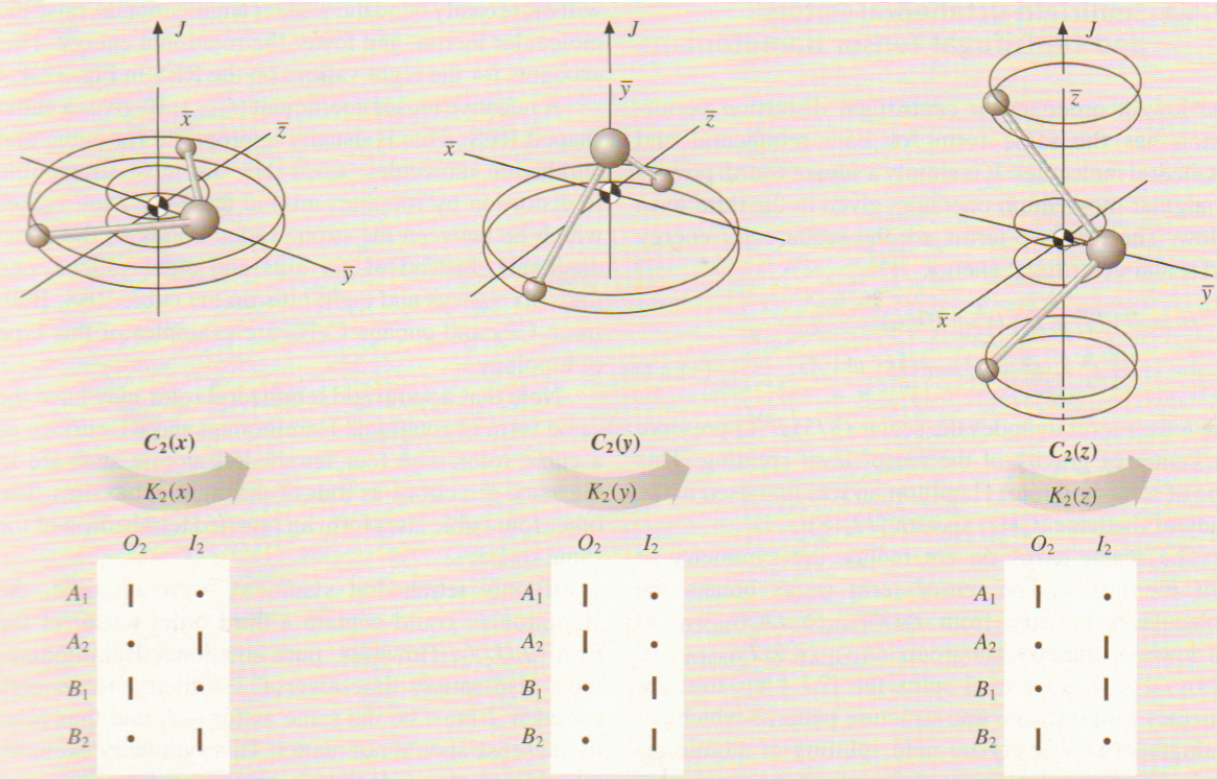

Springer Handbook
of
Atomic, Molecular, and Optical
Physics (2005)
Fig.32.2 and 32.3 p. 495-497

after QTforCA Unit 8. Ch. 25 Fig. 25.4.2

Examples of Group \supset Sub-group correlation

$D_2 \supset C_2(x)$

$D_2 \supset C_2(y)$

$D_2 \supset C_2(z)$

D_2	1	R_x	R_y	R_z
A_1	1	1	1	1
A_2	1	-1	1	-1
B_1	1	1	-1	-1
B_2	1	-1	-1	1

C_{2x}	0_2	1_2
A_1	1	.
A_2	.	1
B_1	1	.
B_2	.	1

C_{2y}	0_2	1_2
A_1	1	.
A_2	1	.
B_1	.	1
B_2	.	1

C_{2z}	0_2	1_2
A_1	1	.
A_2	.	1
B_1	.	1
B_2	1	.

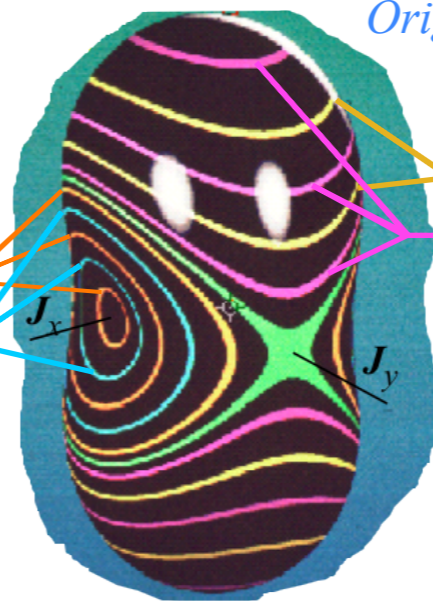

Original color mixing scheme gives

yellow $1_2=(A_2B_1)$

purple $0_2=(A_1B_2)$

for z-prolate axis

orange $0_2=(A_1B_1)$

cyan $1_2=(A_2B_2)$

for x-oblate axis

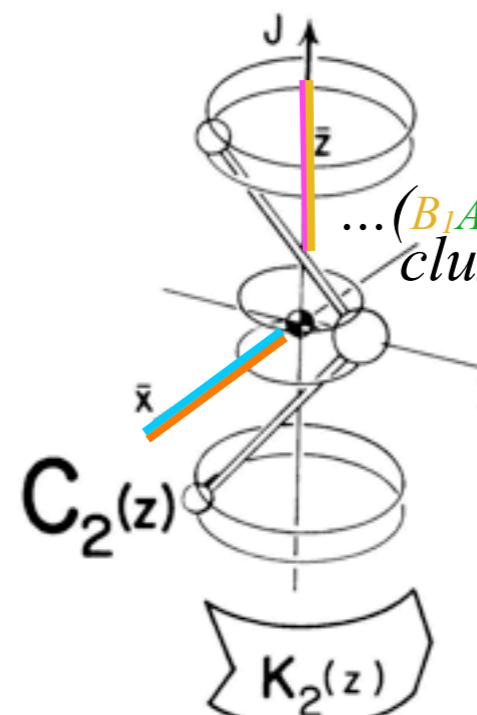
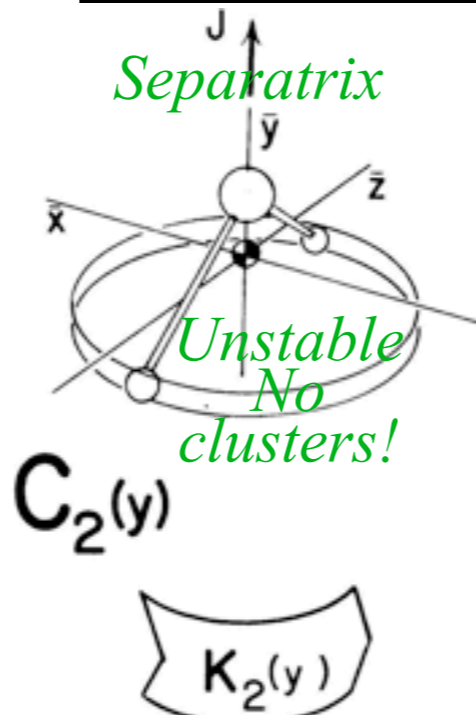
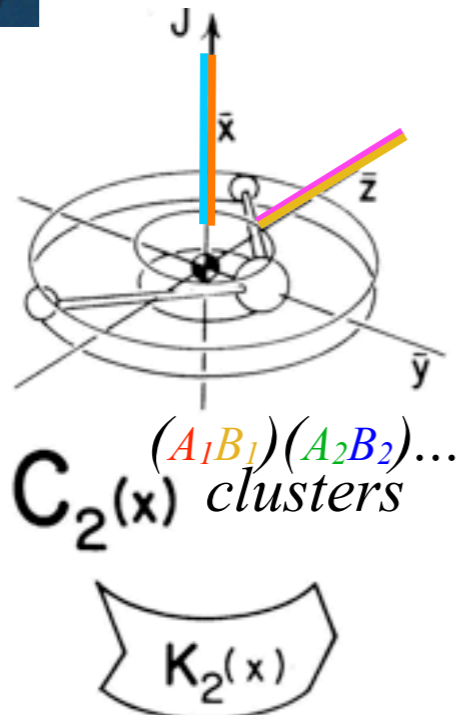
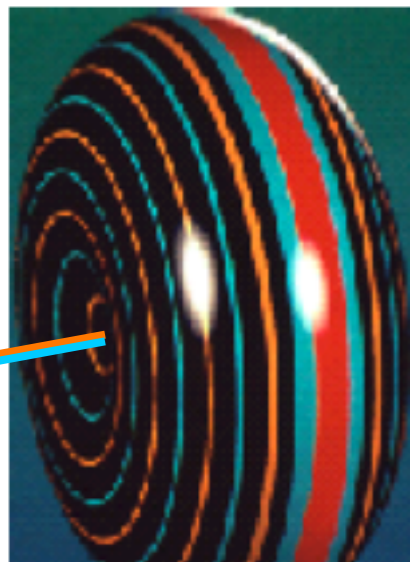

Separatrix

Unstable No clusters!

... $(B_1A_2)(B_2A_1)$ clusters

Fig. 25.4.3 Correlations between the asymmetric top symmetry D_2 and subgroups $C_2(x)$, $C_2(y)$, and $C_2(z)$.

VISUALIZING THE $J=10$ LEVELS OF AN ASYMMETRIC TOP

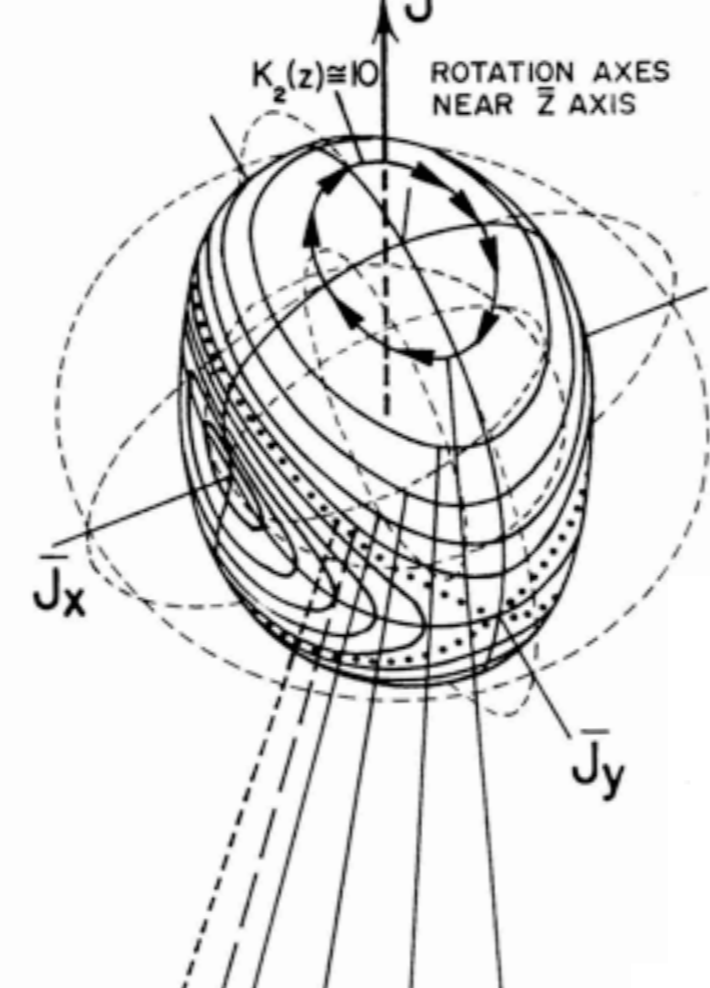
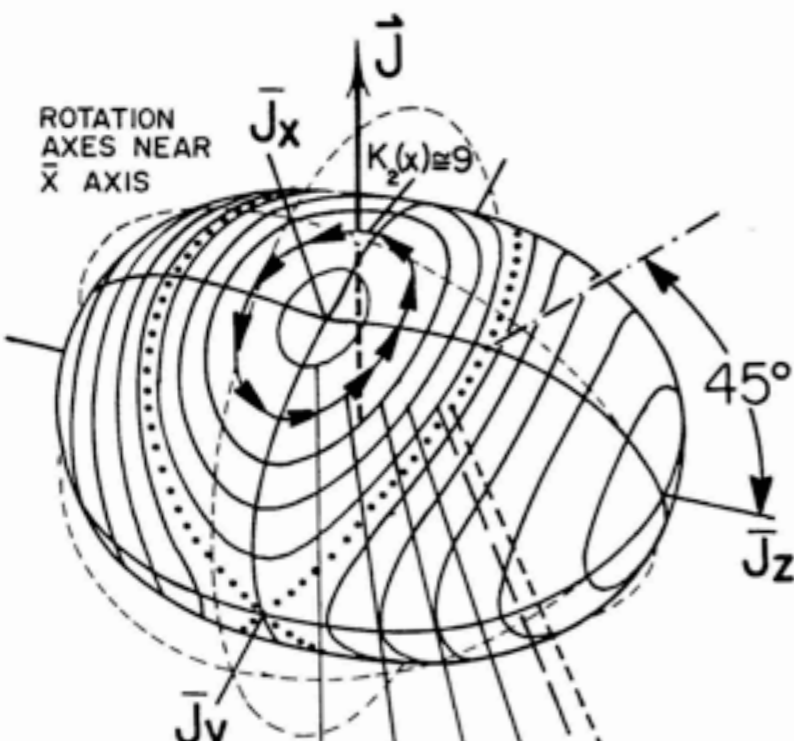

D_2	1	R_x	R_y	R_z
A_1	1	1	1	1
A_2	1	-1	1	-1
B_1	1	1	-1	-1
B_2	1	-1	-1	1

Examples of Group \supset Sub-group correlation

$D_2 \supset C_2(x)$

$D_2 \supset C_2(y)$

$D_2 \supset C_2(z)$

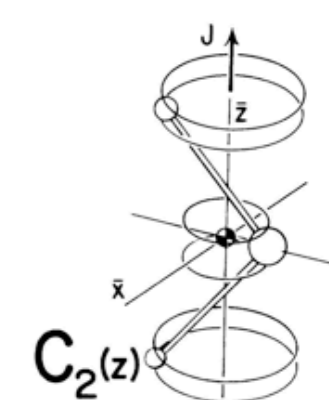
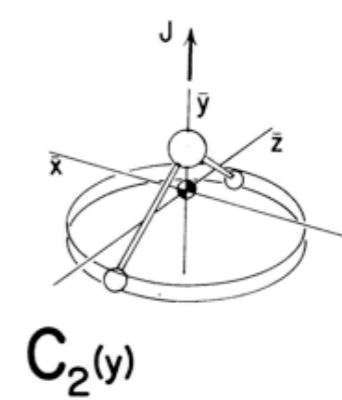
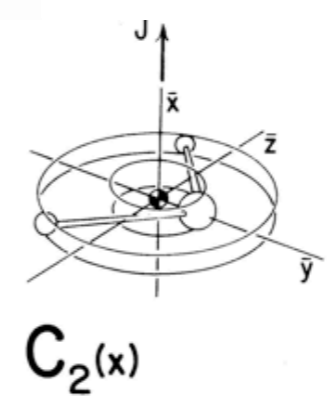

C_{2x}	0_2	1_2
A_1	1	·
A_2	·	1
B_1	1	·
B_2	·	1

C_{2y}	0_2	1_2
A_1	1	·
A_2	1	·
B_1	·	1
B_2	·	1

C_{2z}	0_2	1_2
A_1	1	·
A_2	·	1
B_1	·	1
B_2	1	·

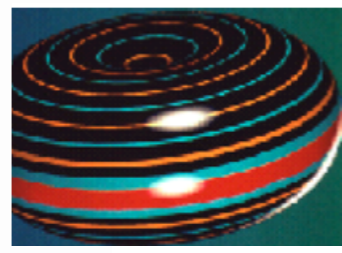
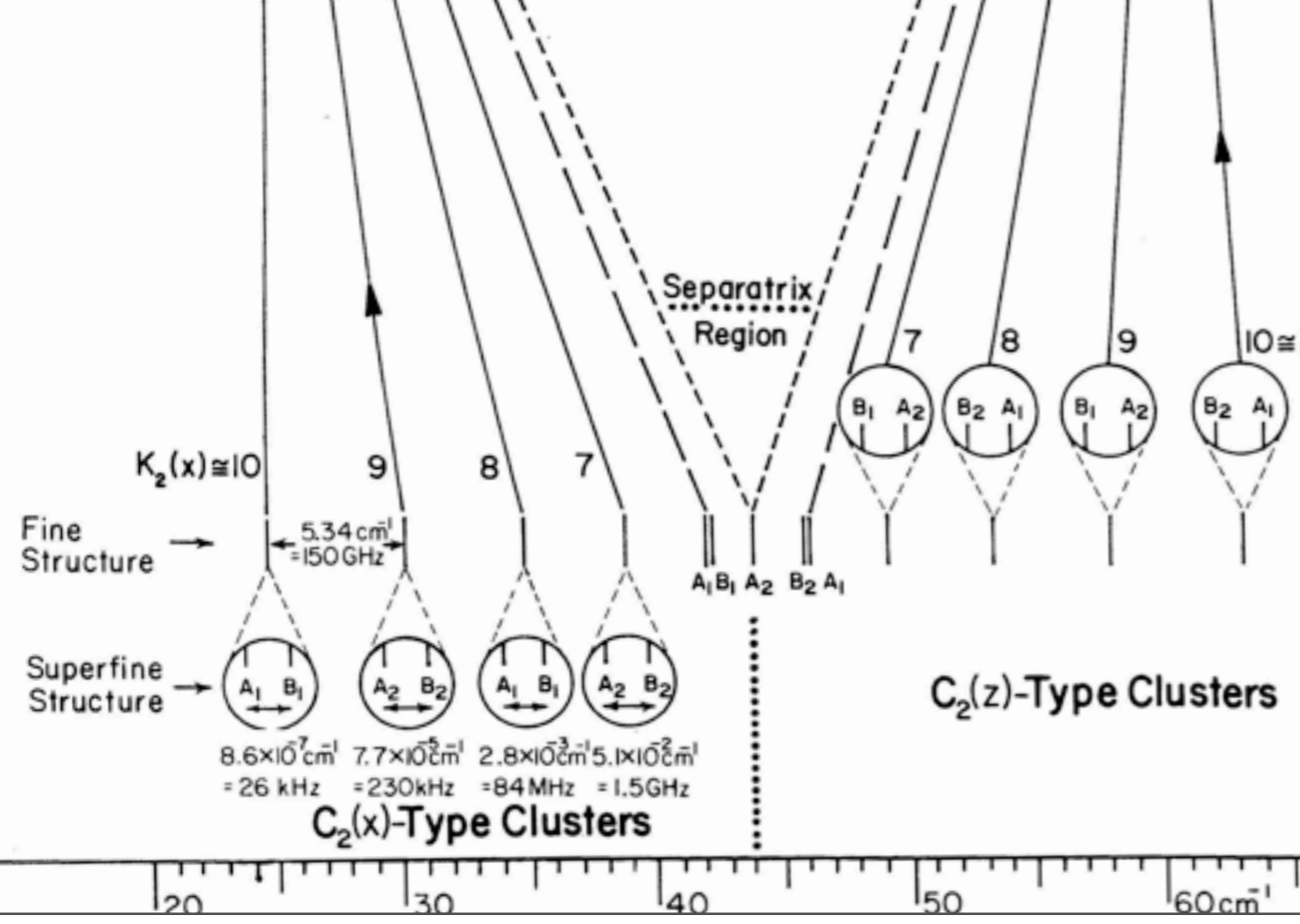
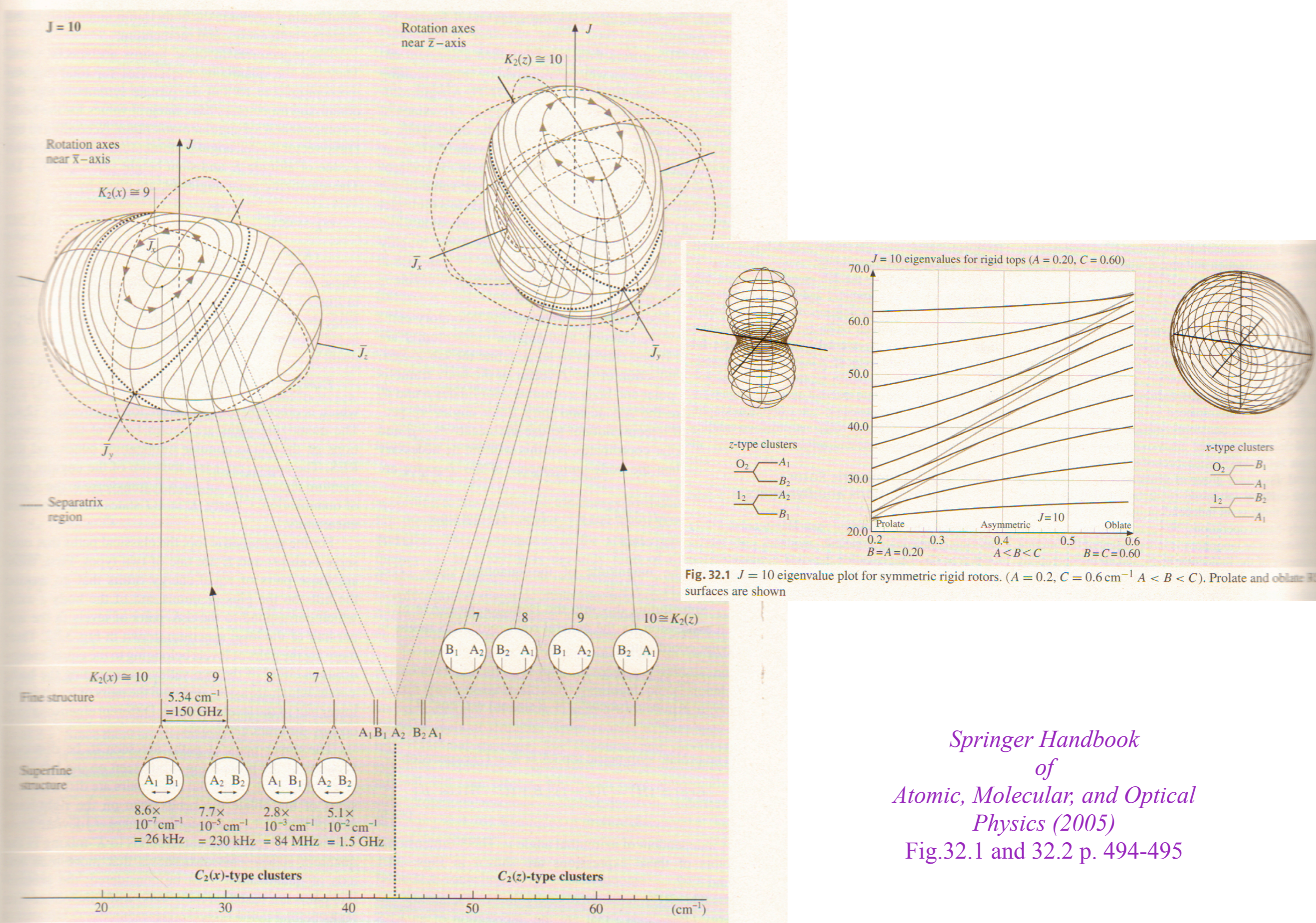
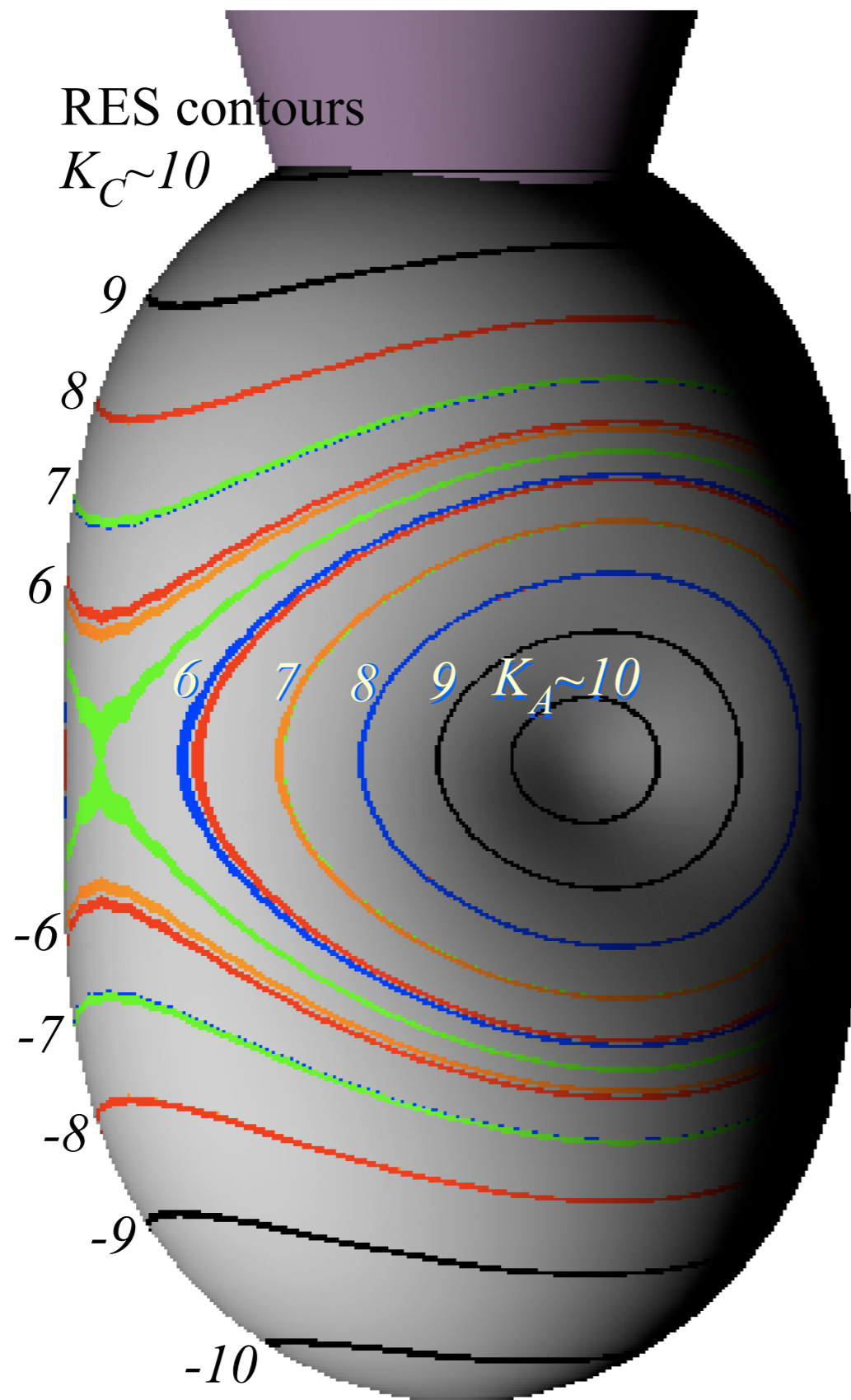

Fig. 25.4.2 $J = 10$ asymmetric top energy levels and related RE surface paths ($A = 0.2, B = 0.4, C = 0.6$). Clustered pairs of levels are indicated in magnifying circles that show superfine splittings.



Springer Handbook
of
Atomic, Molecular, and Optical
Physics (2005)
Fig.32.1 and 32.2 p. 494-495



Separatrix circle pair
 dihedral angle

$$\theta_{sep} = \text{atan}\left(\frac{A-B}{B-C}\right)$$

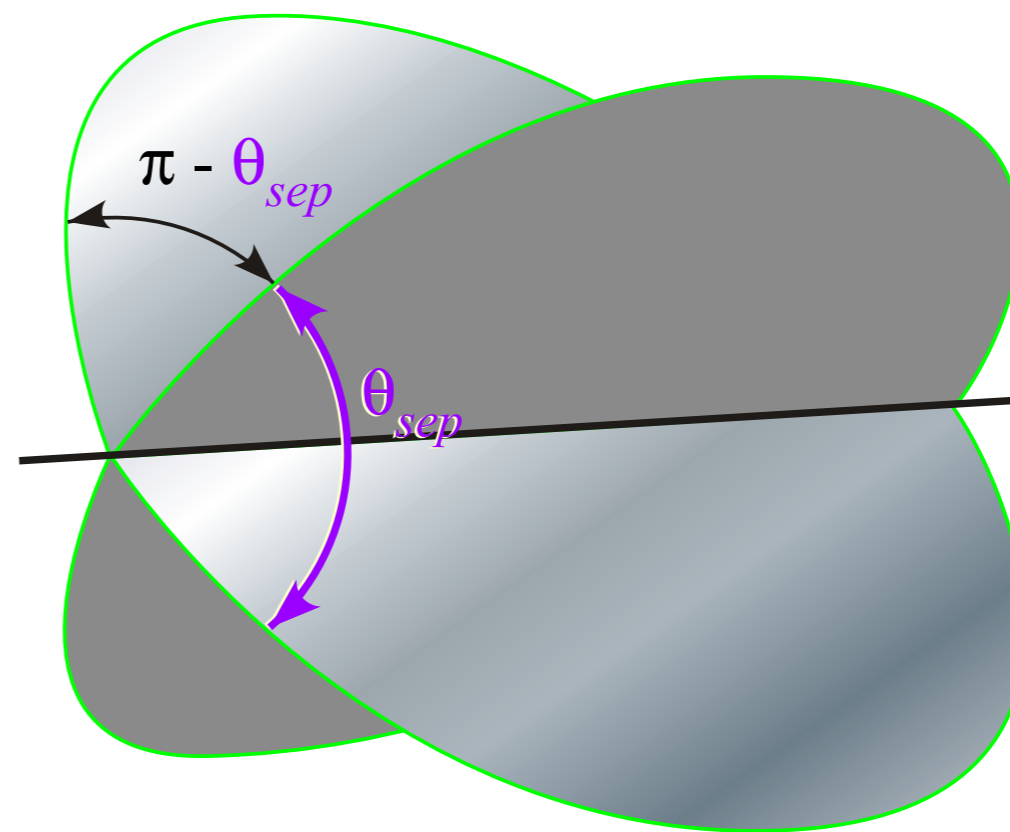

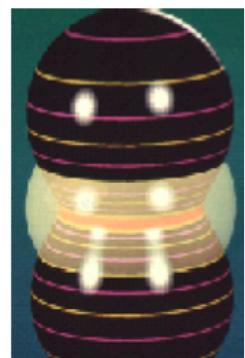

C_{2y}	0_2	1_2
A_1	1	.
A_2	1	.
B_1	.	1
B_2	.	1

D_2	1	R_x	R_y	R_z
A_1	1	1	1	1
A_2	1	-1	1	-1
B_1	1	1	-1	-1
B_2	1	-1	-1	1

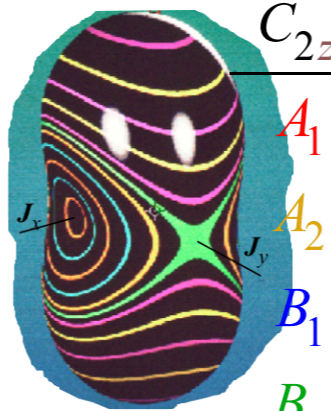

C_{2z}	0_2	1_2
A_1	1	.
A_2	.	1
B_1	.	1
B_2	1	.

C_{2x}	0_2	1_2
A_1	1	.
A_2	.	1
B_1	1	.
B_2	.	1

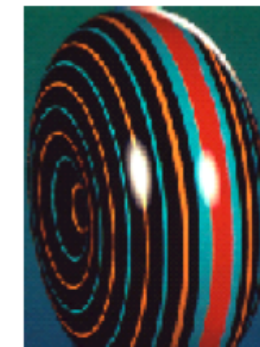

Revised color mixing scheme

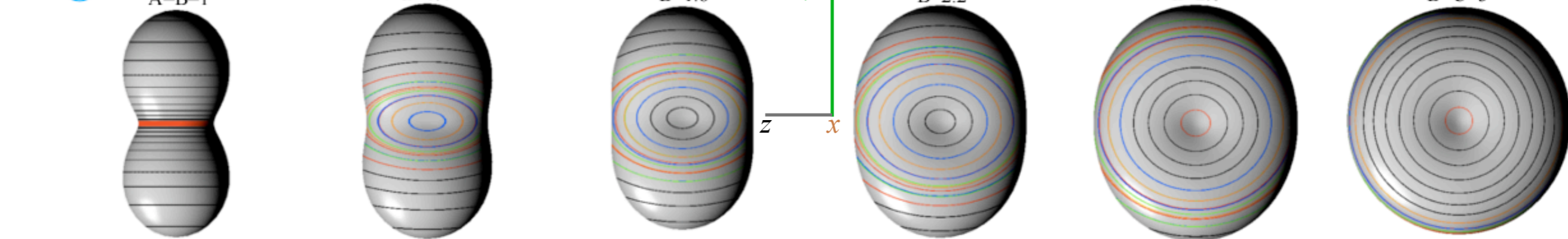
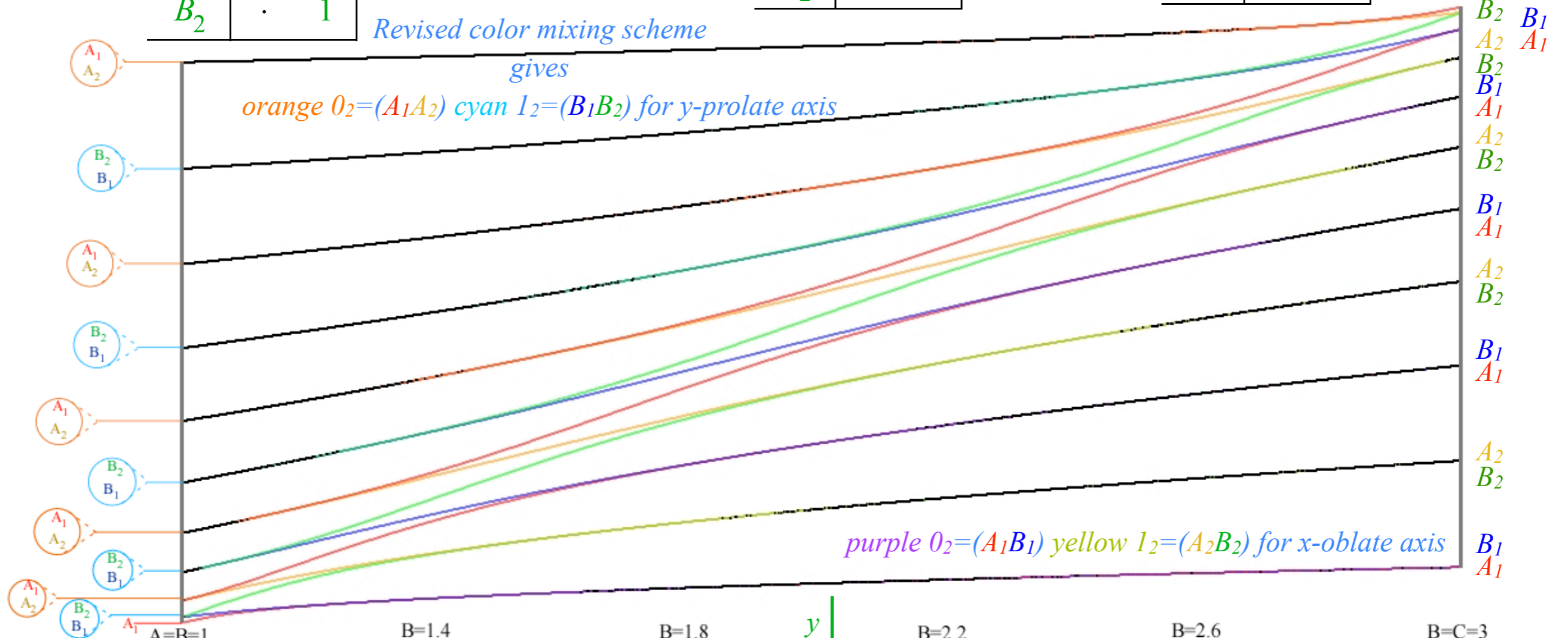

(Revised color mixing scheme used here)

Int.J.Molecular Science 14.(2013) Fig.4 p. 734

Review :

*Symmetric rigid quantum rotor analysis of $R(2)$ Hamiltonian $\mathbf{H} = B\mathbf{J}_x^2 + B\mathbf{J}_y^2 + C\mathbf{J}_z^2$
Rotational Energy Surfaces (RE or RES) and $R(3) \sim U(2)$ representations*

*Asymmetric rigid quantum rotor analysis of D_2 Hamiltonian $\mathbf{H} = A\mathbf{J}_x^2 + B\mathbf{J}_y^2 + C\mathbf{J}_z^2$
RES and Multipole \mathbf{T}_q^k tensor expansions*

Atomic or molecular $R(3)$ ℓ -level or $2\ell+1$ -multiplet splitting (Review of D_3)

$R(3) \supset D_2$ character analysis of ℓ -level or $2\ell+1$ -multiplet splitting in D_2

Detailed angular momentum operator analysis for $J=1-2$ for D_2 symmetry

Asymmetric rotor levels and RES plots for high- J

 *Octahedral semi-rigid quantum rotor analysis of O_h Hamiltonian $\mathbf{H} = B\mathbf{J} \cdot \mathbf{J} + t_{044}\mathbf{T}^{[4]}$* 

Spherical rotor levels and RES plots of O_h tensor eigenvalues

$R(3) \subset O(3) \supset O_h \supset O$ character analysis of ℓ -level or $2\ell+1$ -multiplet splitting in O

Visualizing $J=30$ quantum levels of cubic, octahedral, and tetrahedral molecules

SF_6 spectral fine structure P(88)

CF_4 spectral fine structure P(54)

Semi Rigid Rotor Hamiltonian: Centrifugal and Coriolis terms...

$$\mathbf{H} = A\mathbf{J}_x^2 + B\mathbf{J}_y^2 + C\mathbf{J}_z^2 + t_{xxxx}\mathbf{J}_x^4 + t_{xyyy}\mathbf{J}_x^2\mathbf{J}_y^2 + \dots$$

Semi Rigid O_h or T_d Spherical Top: (Hecht Hamiltonian 1960)

$$\mathbf{H} = B\left(\mathbf{J}_x^2 + \mathbf{J}_y^2 + \mathbf{J}_z^2\right) + t_{440}\left(\mathbf{J}_x^4 + \mathbf{J}_y^4 + \mathbf{J}_z^4 - \frac{3}{5}J^4\right) + \dots$$

$$= B\mathbf{J}^2 + t_{440}\left(\mathbf{T}_0^4 + \sqrt{\frac{5}{14}}\left[\mathbf{T}_4^4 + \mathbf{T}_{-4}^4\right]\right) + \dots$$

*precessing
J vector*

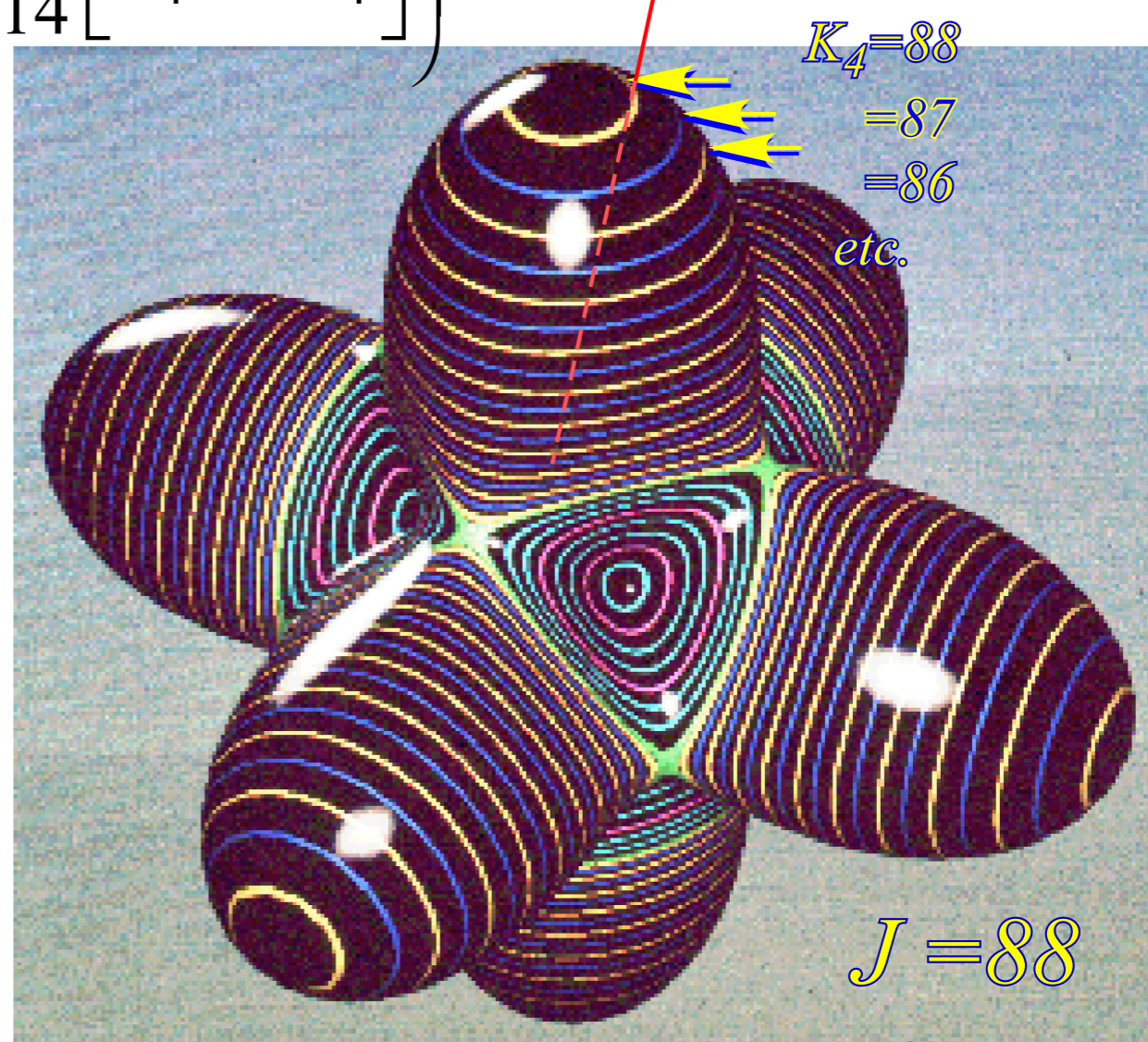
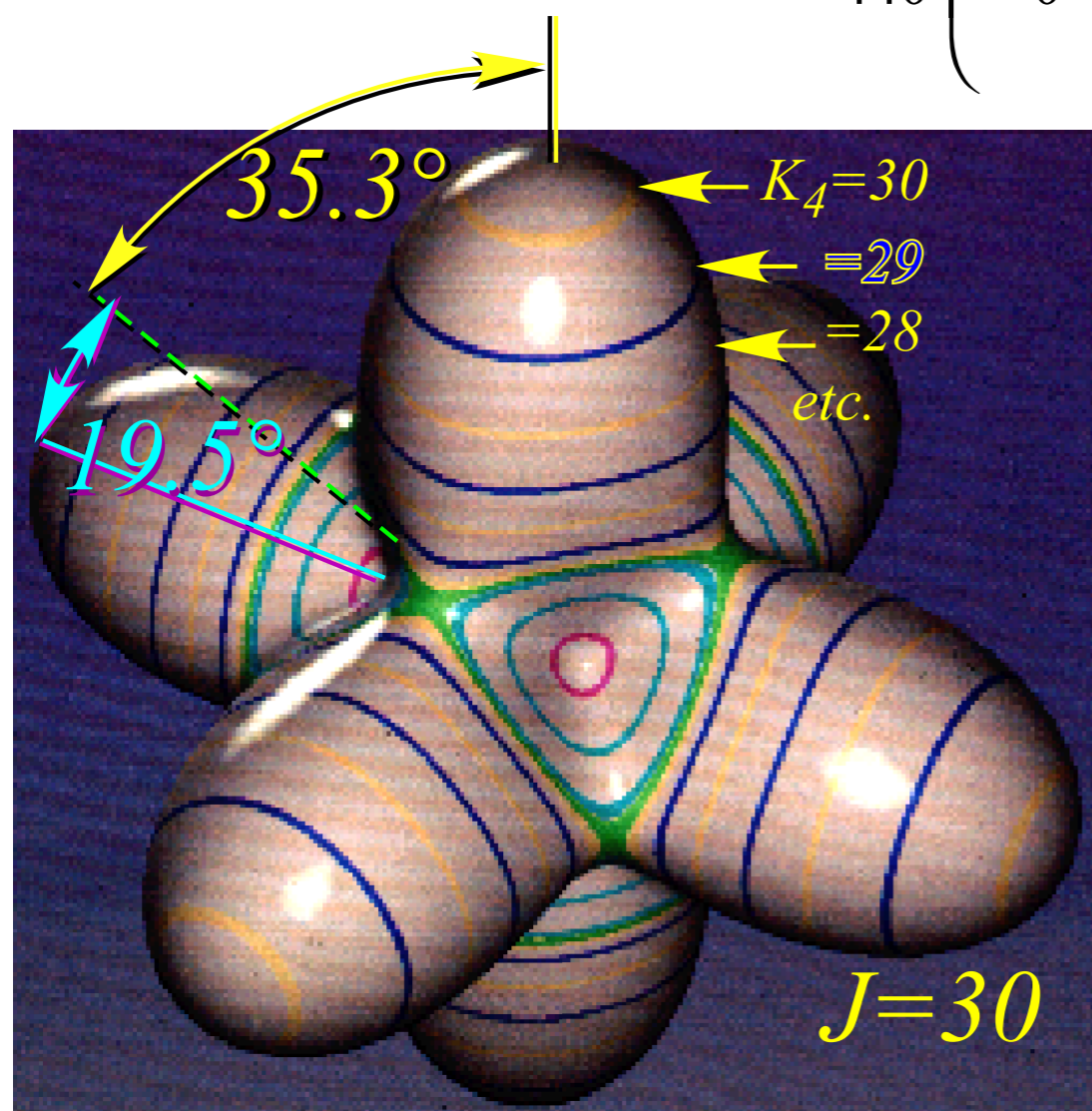

after QTforCA Unit 8. Ch. 25 Fig. 25.4.5

Review :

*Symmetric rigid quantum rotor analysis of $R(2)$ Hamiltonian $\mathbf{H} = B\mathbf{J}_x^2 + B\mathbf{J}_y^2 + C\mathbf{J}_z^2$
Rotational Energy Surfaces (RE or RES) and $R(3) \sim U(2)$ representations*

*Asymmetric rigid quantum rotor analysis of D_2 Hamiltonian $\mathbf{H} = A\mathbf{J}_x^2 + B\mathbf{J}_y^2 + C\mathbf{J}_z^2$
RES and Multipole \mathbf{T}_q^k tensor expansions*

Atomic or molecular $R(3)$ ℓ -level or $2\ell+1$ -multiplet splitting (Review of D_3)

$R(3) \supset D_2$ character analysis of ℓ -level or $2\ell+1$ -multiplet splitting in D_2

Detailed angular momentum operator analysis for $J=1-2$ for D_2 symmetry

Asymmetric rotor levels and RES plots for high- J

Octahedral semi-rigid quantum rotor analysis of O_h Hamiltonian $\mathbf{H} = B\mathbf{J} \cdot \mathbf{J} + t_{044}\mathbf{T}^{[4]}$

Spherical rotor levels and RES plots of O_h tensor eigenvalues

$R(3) \subset O(3) \supset O_h \supset O$ character analysis of ℓ -level or $2\ell+1$ -multiplet splitting in O

Visualizing $J=30$ quantum levels of cubic, octahedral, and tetrahedral molecules

SF_6 spectral fine structure P(88)

CF_4 spectral fine structure P(54)

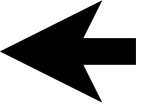
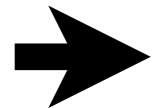

	Trace $\mathcal{D}^l(\omega 00)$					Single Electron Orbital Spectroscopic Labeling		Frequency of O Irreps					
	$\omega = 0^\circ$	$\omega = 120^\circ$	$\omega = 180^\circ$	$\omega = 90^\circ$	$\omega = 180^\circ$			f^{A_1}	f^{A_2}	f^E	f^{T_1}	f^{T_2}	
$l = 0$	1	1	1	1	1	s_g	$l = 0$	1	·	·	·	·	A_{1g}
1	3	0	-1	1	-1	p_u	1	·	·	·	1	·	T_{1u}
2	5	-1	1	-1	1	d_g	2	·	·	1	·	1	$E_g + T_{2g}$
3	7	1	-1	-1	-1	f_u	3	·	1	·	1	1	$A_{2u} + T_{1u} + T_{2u}$
4	9	0	1	1	1	g_g	4	1	·	1	1	1	$A_{1g} + E_g + T_{1g} + T_{2g}$
5	11	-1	-1	1	-1	h_u	5	·	·	1	2	1	
6	13	1	1	-1	1	i_g	6	1	1	1	1	2	
7	15	0	-1	-1	-1	k_u	7	·	1	1	2	2	
8	17	-1	1	1	1	l_g	8	1	·	2	2	2	
9	19	1	-1	1	-1	m_u	9	1	1	1	3	2	
10	21	0	1	-1	1	n_g	10	1	1	2	2	3	
11	23	-1	-1	-1	-1	o_u	11	·	1	2	3	3	
12	25	1	1	1	1	q_g	12	2	1	2	3	3	
13	27	0	-1	1	-1	r_u	13	1	1	2	4	3	
14	29	-1	1	-1	1	t_g	14	1	1	3	3	4	
15	31	1	-1	-1	-1	u_u	15	1	2	2	4	4	
16	33	0	1	1	1		16	2	1	3	4	4	
17	35	-1	-1	1	-1		17	1	1	3	5	4	
18	37	1	1	-1	1		18	2	2	3	4	5	
19	39	0	-1	-1	-1		19	1	2	3	5	5	
20	41	-1	1	1	1	(5.6.5a)	20	2	1	4	5	5	(5.6.5b)

$R(3)$ characters

$$\chi^l(\Theta) = \frac{\sin(l + \frac{1}{2})\Theta}{\sin \frac{\Theta}{2}}$$

O characters

O	1	r	R^2	R^3	i_k
A_1	1	1	1	1	1
A_2	1	1	1	-1	-1
E	2	-1	2	0	0
T_1	3	0	-1	1	-1
T_2	3	0	-1	-1	1

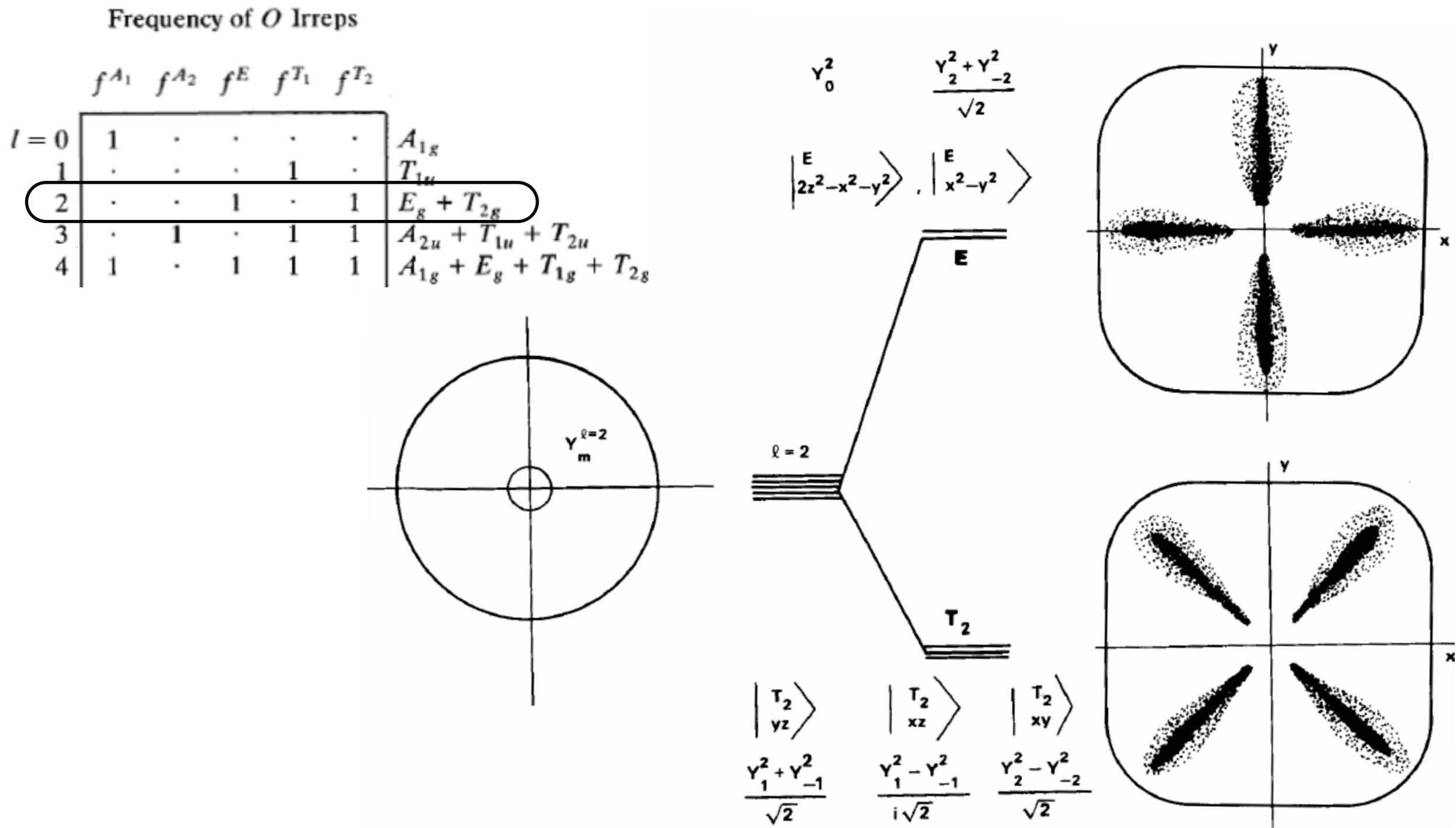
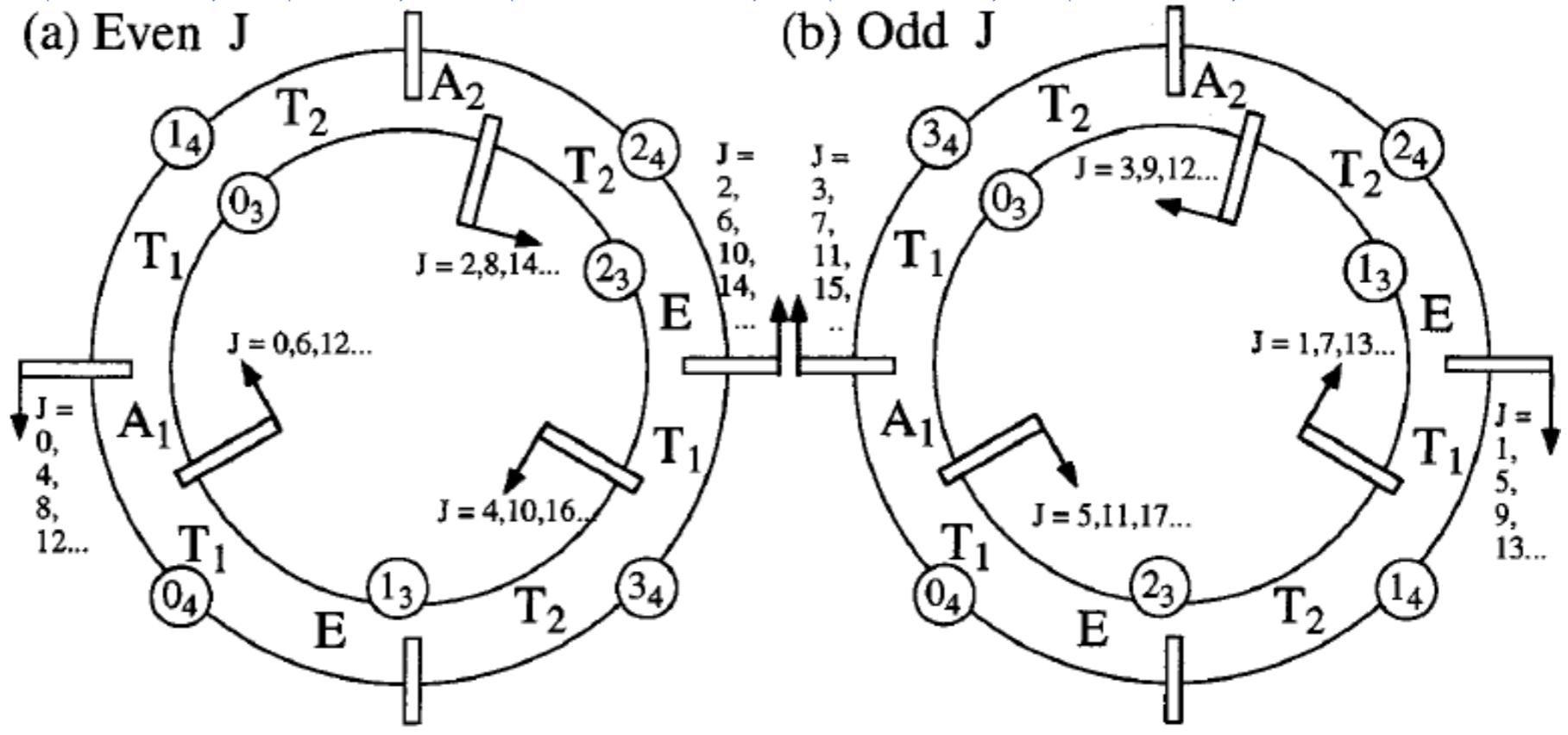

Figure 5.6.3 Detailed sketch of octahedral splitting of a d orbital. The wave functions $\left\langle \begin{smallmatrix} E \\ 2 \end{smallmatrix} \right\rangle$ and $\left\langle \begin{smallmatrix} T_2 \\ 3 \end{smallmatrix} \right\rangle$ are sketched inside the equipotential contour $x^4 + y^4 = \text{constant}$ ($z = 0$).

$(A_1 T_1 E)_{0_4} (T_2 T_1)_{3_4} (E T_2 A_2)_{2_4} (T_2 T_1)_{1_4} \dots (A_2 T_2 T_1 A_1)_{0_3} (T_1 E T_2)_{1_3} (T_1 E T_2)_{2_3} \dots$



Bands or “Clusters” of levels maintain order but change spacing as they adapt to varying local symmetries by crossing separatrices in their phase space (see p. 73-77)

Figure 5.6.9 Mnemonic wheels for octahedral- O orbital. Splitting of J levels for (a) even J and (b) odd J .

$(A_1 T_1 E)_{0_4} (T_2 T_1)_{3_4} (E T_2 A_2)_{2_4} (T_2 T_1)_{1_4} \dots (A_2 T_2 T_1 A_1)_{0_3} (T_1 E T_2)_{1_3} (T_1 E T_2)_{2_3} \dots$

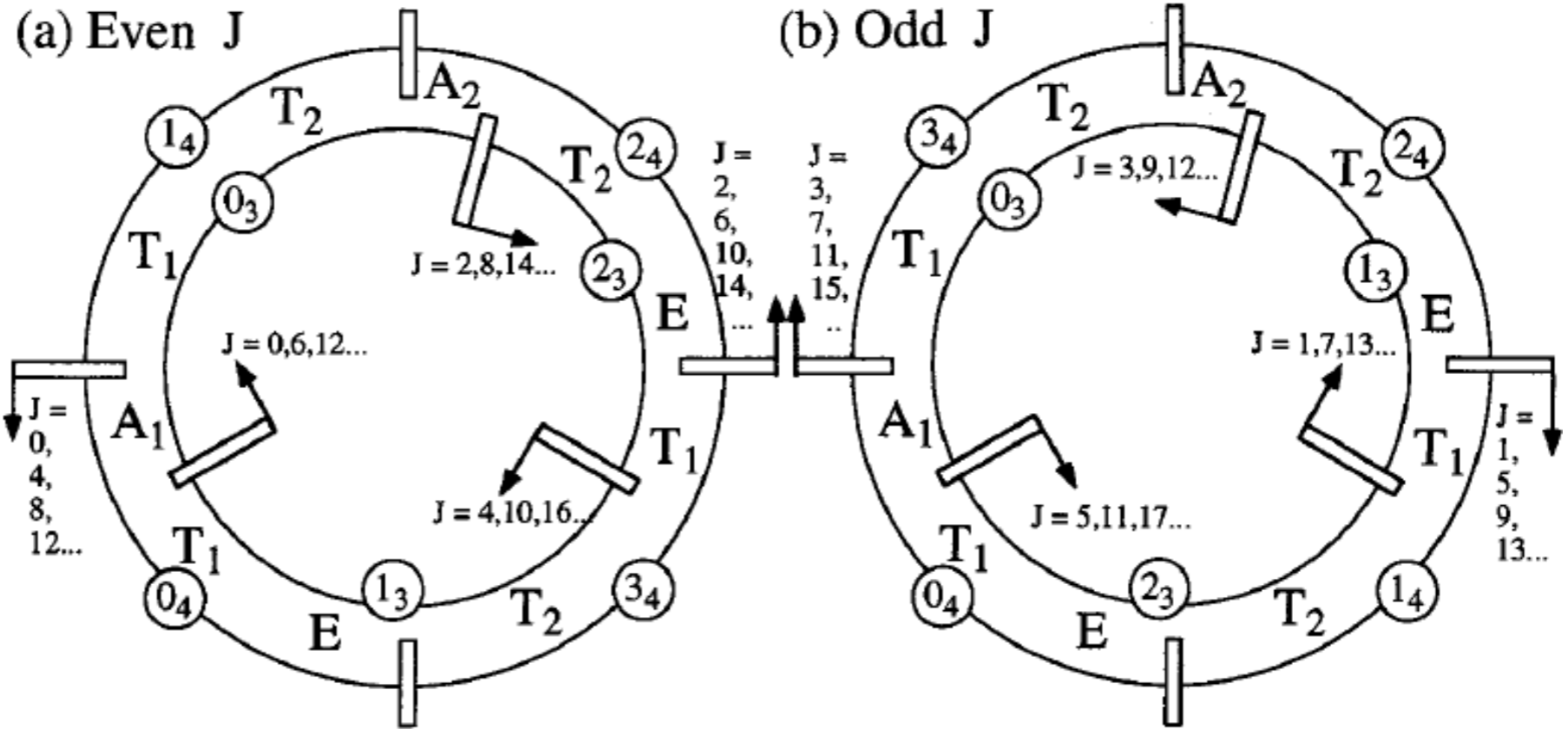
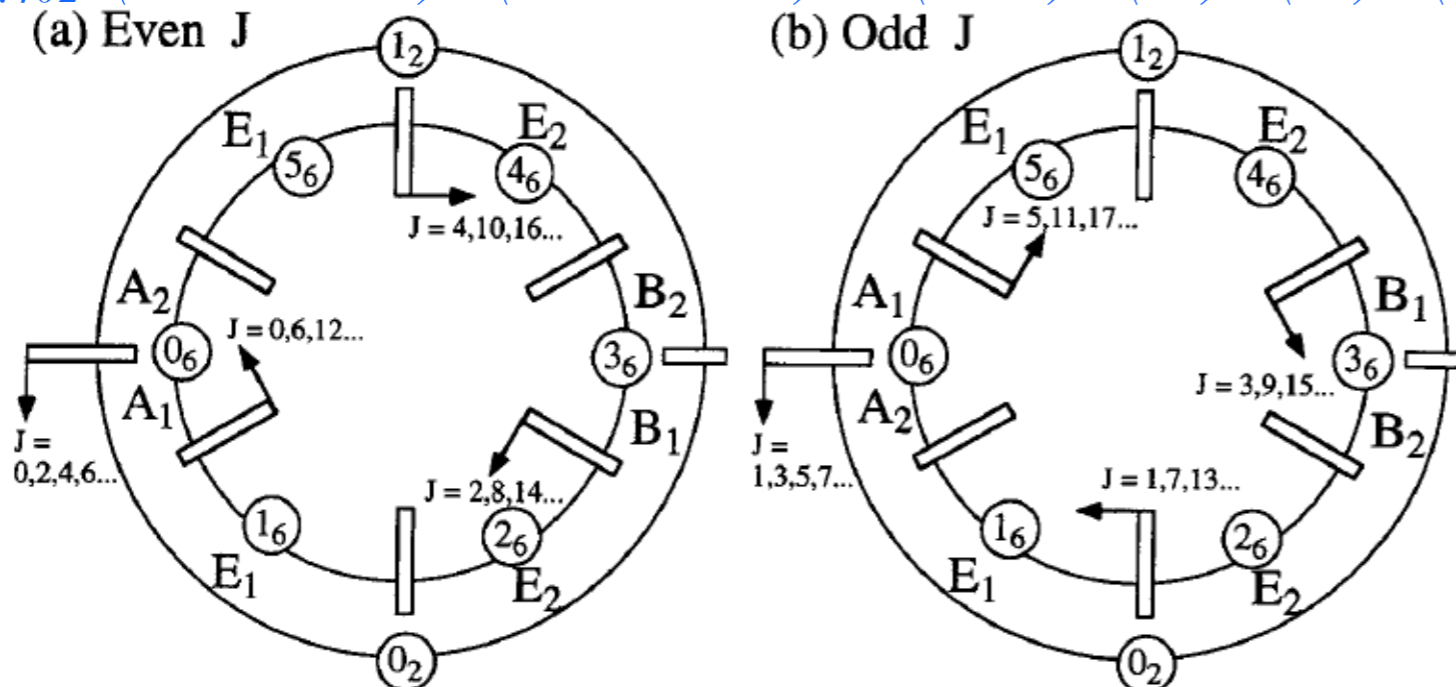

Figure 5.6.9 Mnemonic wheels for octahedral- O orbital. Splitting of J levels for (a) even J and (b) odd J .

Bands or "Clusters" of levels maintain order but change spacing as they adapt to varying local symmetries by crossing separatrices in their phase space (see p. 73-77)

D_6 wheel

Ch.5 p.402 $(A_1 E_1 E_2 B_1)_{0_2} (B_2 E_2 E_1 A_2)_{1_2} \dots (A_2 A_1)_{0_6} (E_1)_{1_6} (E_2)_{2_6} (B_1 B_2)_{3_6} (E_2)_{4_6} (E_1)_{5_6} \dots$



(see p. 63-66 where "band" and "gap" spacing varies with energy)

Review :

*Symmetric rigid quantum rotor analysis of $R(2)$ Hamiltonian $\mathbf{H} = B\mathbf{J}_x^2 + B\mathbf{J}_y^2 + C\mathbf{J}_z^2$
Rotational Energy Surfaces (RE or RES) and $R(3) \sim U(2)$ representations*

*Asymmetric rigid quantum rotor analysis of D_2 Hamiltonian $\mathbf{H} = A\mathbf{J}_x^2 + B\mathbf{J}_y^2 + C\mathbf{J}_z^2$
RES and Multipole \mathbf{T}_q^k tensor expansions*

Atomic or molecular $R(3)$ ℓ -level or $2\ell+1$ -multiplet splitting (Review of D_3)

$R(3) \supset D_2$ character analysis of ℓ -level or $2\ell+1$ -multiplet splitting in D_2

Detailed angular momentum operator analysis for $J=1-2$ for D_2 symmetry

Asymmetric rotor levels and RES plots for high- J

Octahedral semi-rigid quantum rotor analysis of O_h Hamiltonian $\mathbf{H} = B\mathbf{J} \cdot \mathbf{J} + t_{044}\mathbf{T}^{[4]}$

Spherical rotor levels and RES plots of O_h tensor eigenvalues

$R(3) \subset O(3) \supset O_h \supset O$ character analysis of ℓ -level or $2\ell+1$ -multiplet splitting in O

Visualizing $J=30$ quantum levels of cubic, octahedral, and tetrahedral molecules

SF_6 spectral fine structure P(88)

CF_4 spectral fine structure P(54)

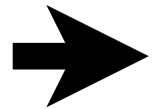

Semi Rigid Rotor Hamiltonian: Centrifugal and Coriolis terms...

$$\mathbf{H} = A\mathbf{J}_x^2 + B\mathbf{J}_y^2 + C\mathbf{J}_z^2 + t_{xxxx}\mathbf{J}_x^4 + t_{xyyy}\mathbf{J}_x^2\mathbf{J}_y^2 + \dots$$

Semi Rigid O_h or T_d Spherical Top: (Hecht Hamiltonian 1960)

$$\mathbf{H} = B\left(\mathbf{J}_x^2 + \mathbf{J}_y^2 + \mathbf{J}_z^2\right) + t_{440}\left(\mathbf{J}_x^4 + \mathbf{J}_y^4 + \mathbf{J}_z^4 - \frac{3}{5}J^4\right) + \dots$$

$$= B\mathbf{J}^2 + t_{440}\left(\mathbf{T}_0^4 + \sqrt{\frac{5}{14}}\left[\mathbf{T}_4^4 + \mathbf{T}_{-4}^4\right]\right) + \dots$$

*precessing
J vector*

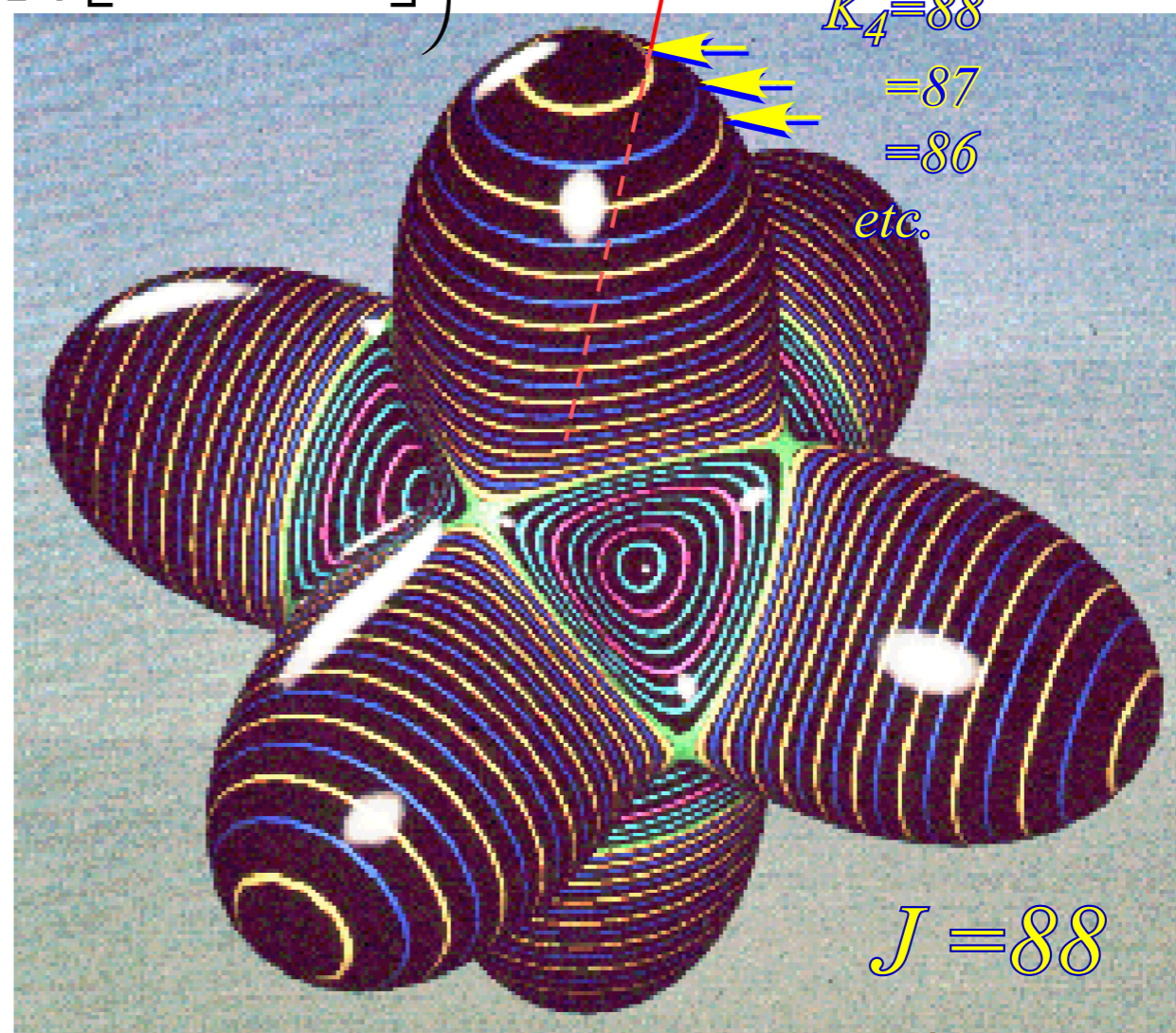
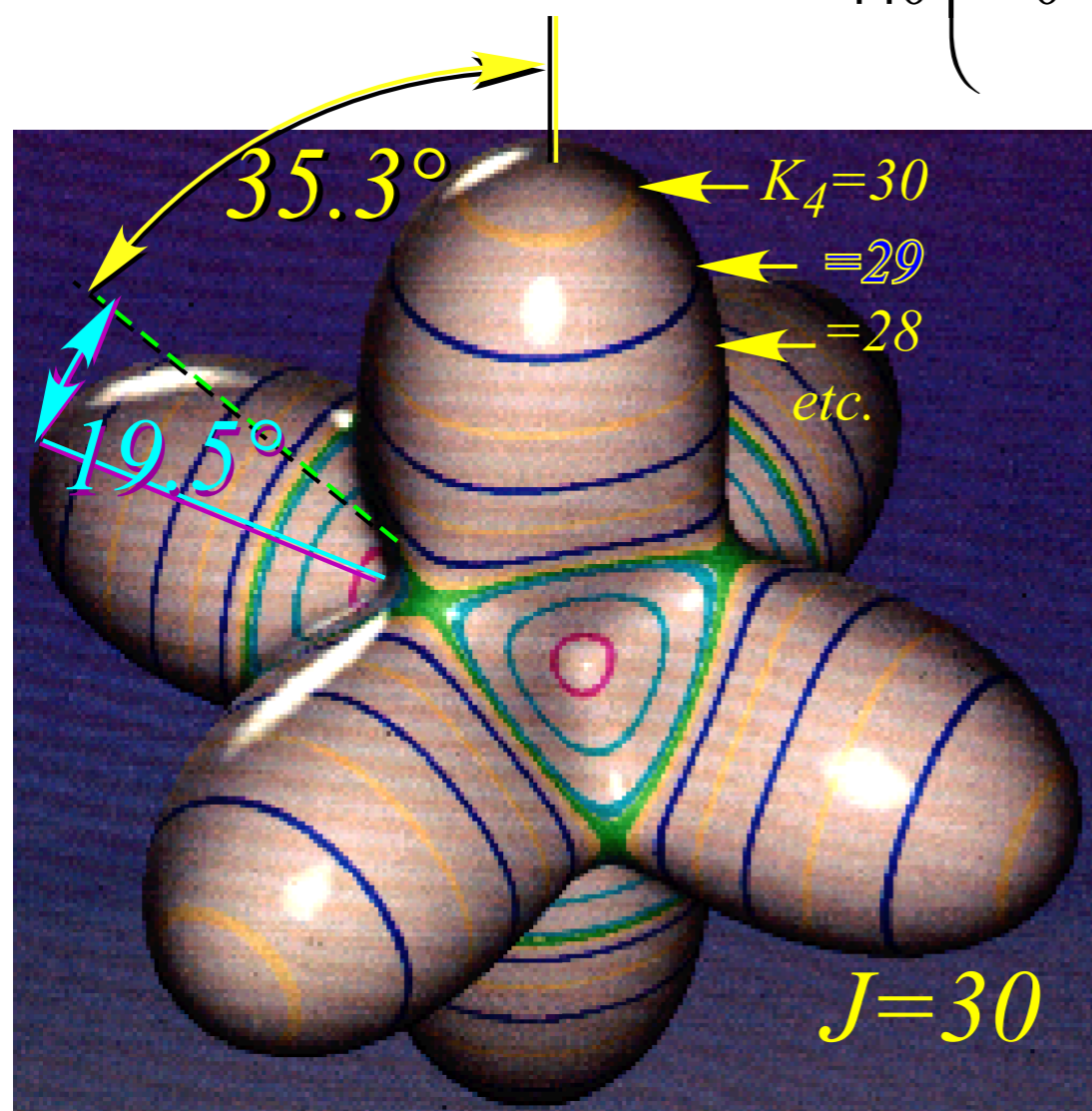

after QTforCA Unit 8. Ch. 25 Fig. 25.4.5

Finding Hamiltonian Eigensolutions by Geometry

using

Uncertainty Cone Angles

$$\cos \Theta_K^J = \frac{K}{\sqrt{J(J+1)}}$$

K

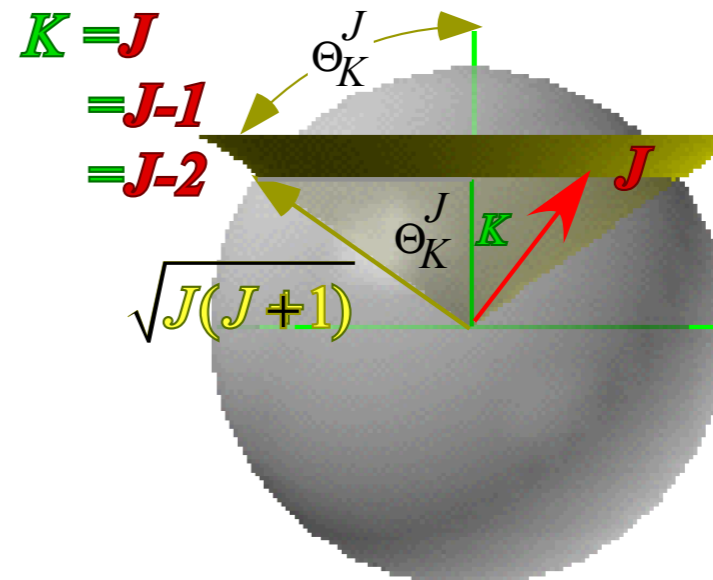

J cone intersects $J=88$ RE surface to give approx. $K=J, J-1, J-2...$ energy levels

O_h or T_d Spherical Top: (Hecht Ro-vib Hamiltonian 1960)

$$\mathbf{H} = B(\mathbf{J}_x^2 + \mathbf{J}_y^2 + \mathbf{J}_z^2) + t_{440} \left(\mathbf{J}_x^4 + \mathbf{J}_y^4 + \mathbf{J}_z^4 - \frac{3}{5} J^4 \right) + \dots$$

$$= B J^2 + t_{440} \left(\mathbf{T}_0^4 + \sqrt{\frac{5}{14}} [\mathbf{T}_4^4 + \mathbf{T}_{-4}^4] \right) + \dots$$

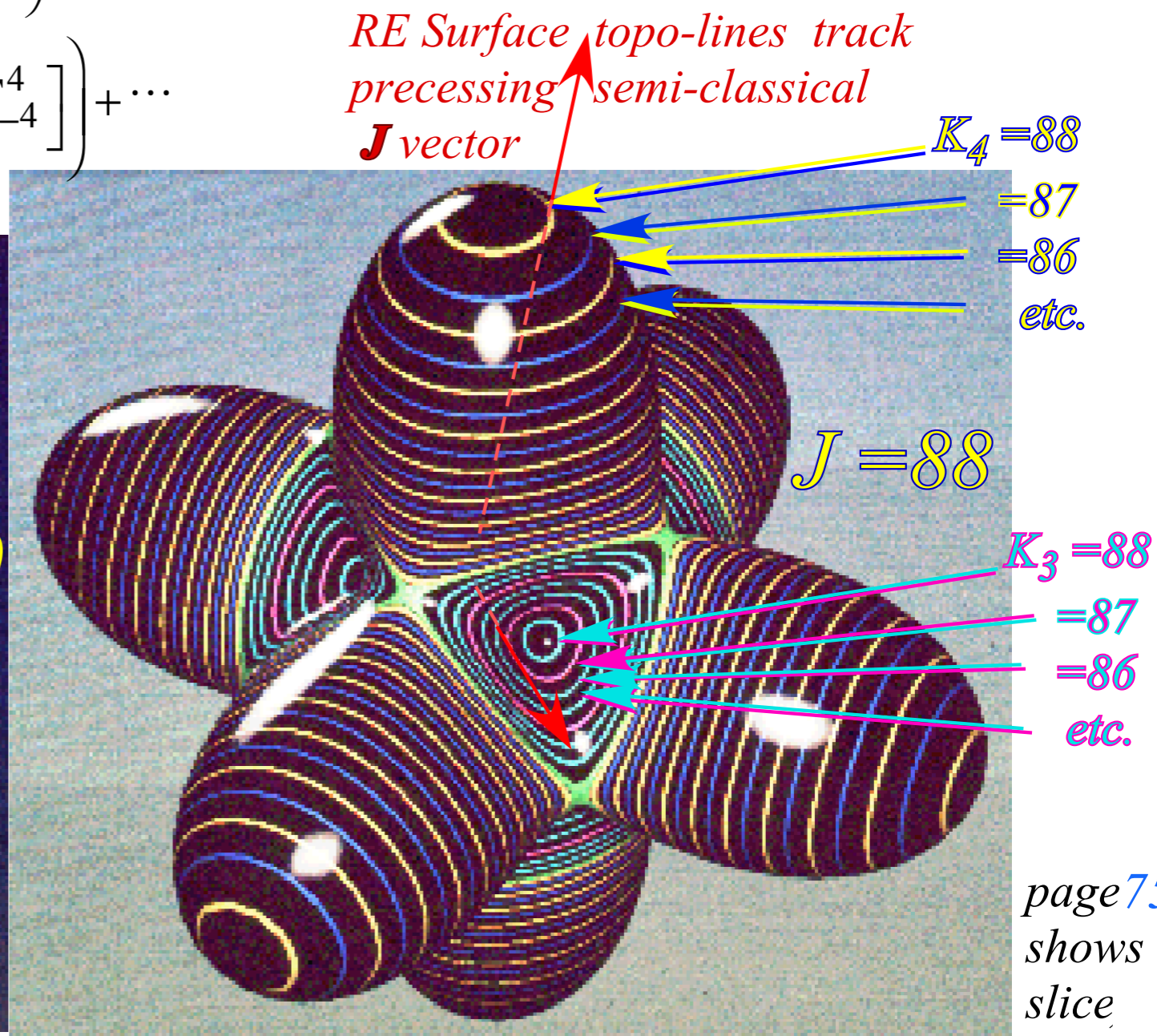
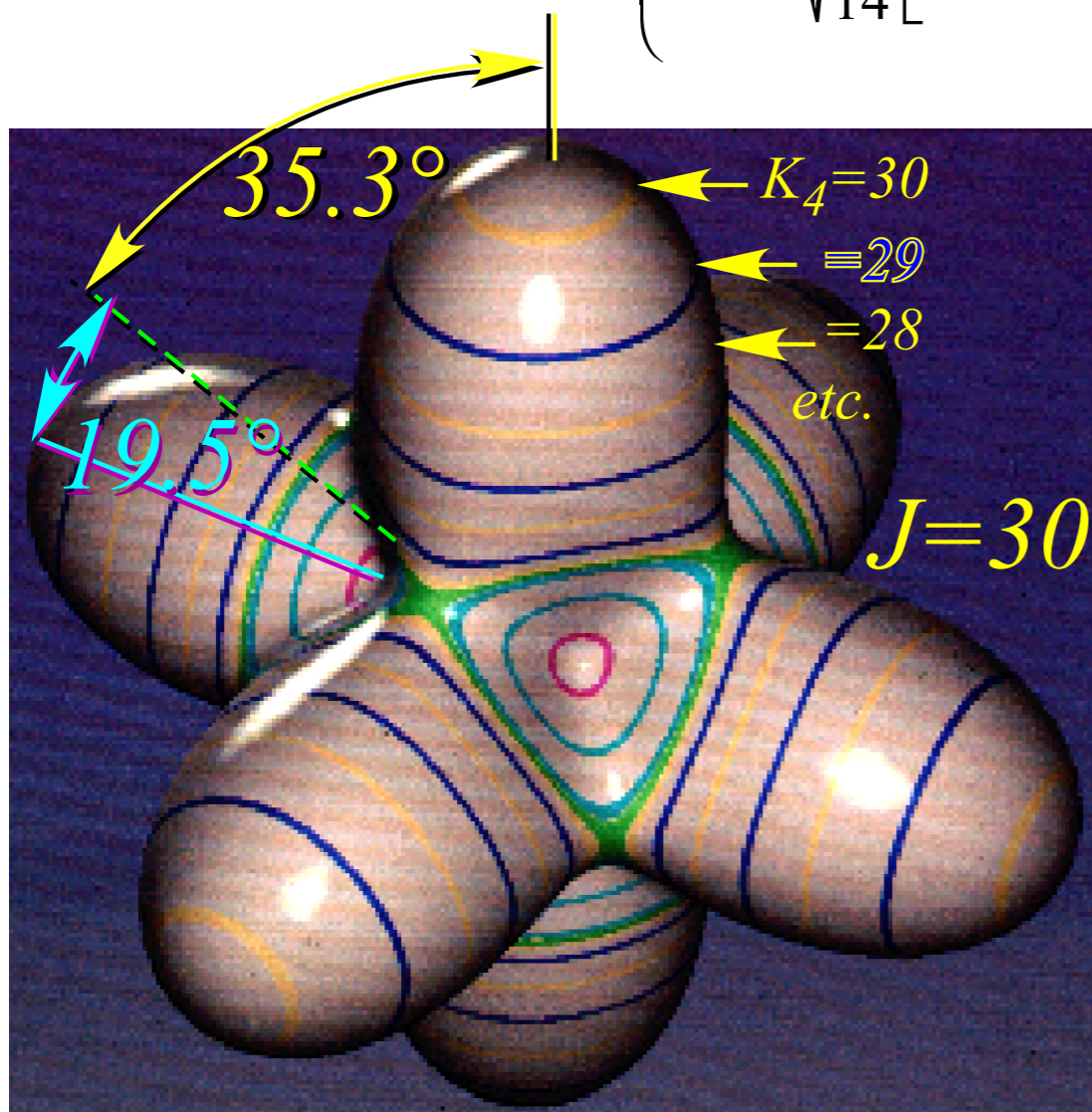

page 75 shows slice

VISUALIZING THE $J=30$ LEVELS OF A SPHERICAL TOP

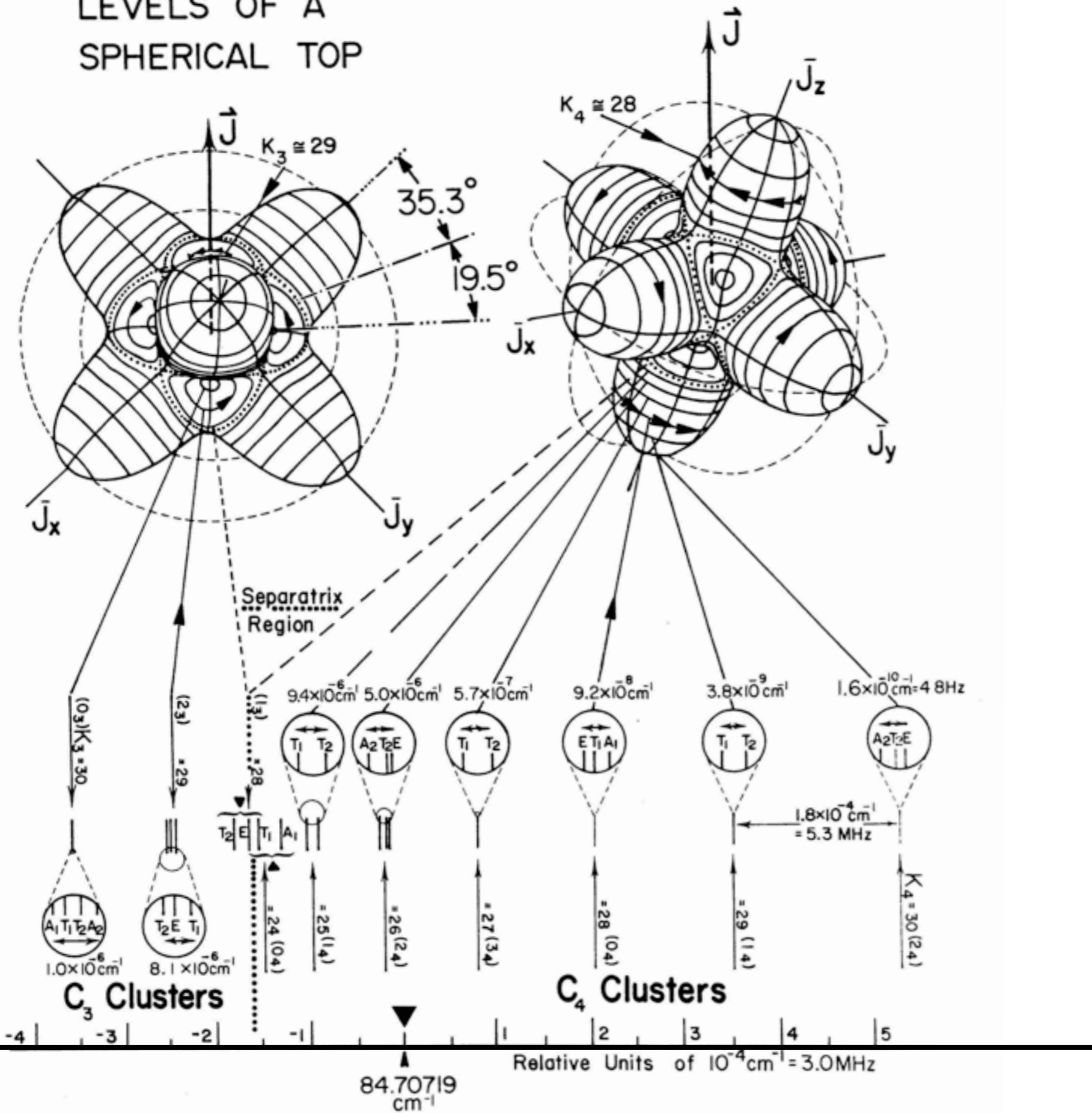

VISUALIZING THE J = 30 LEVELS OF A SPHERICAL TOP

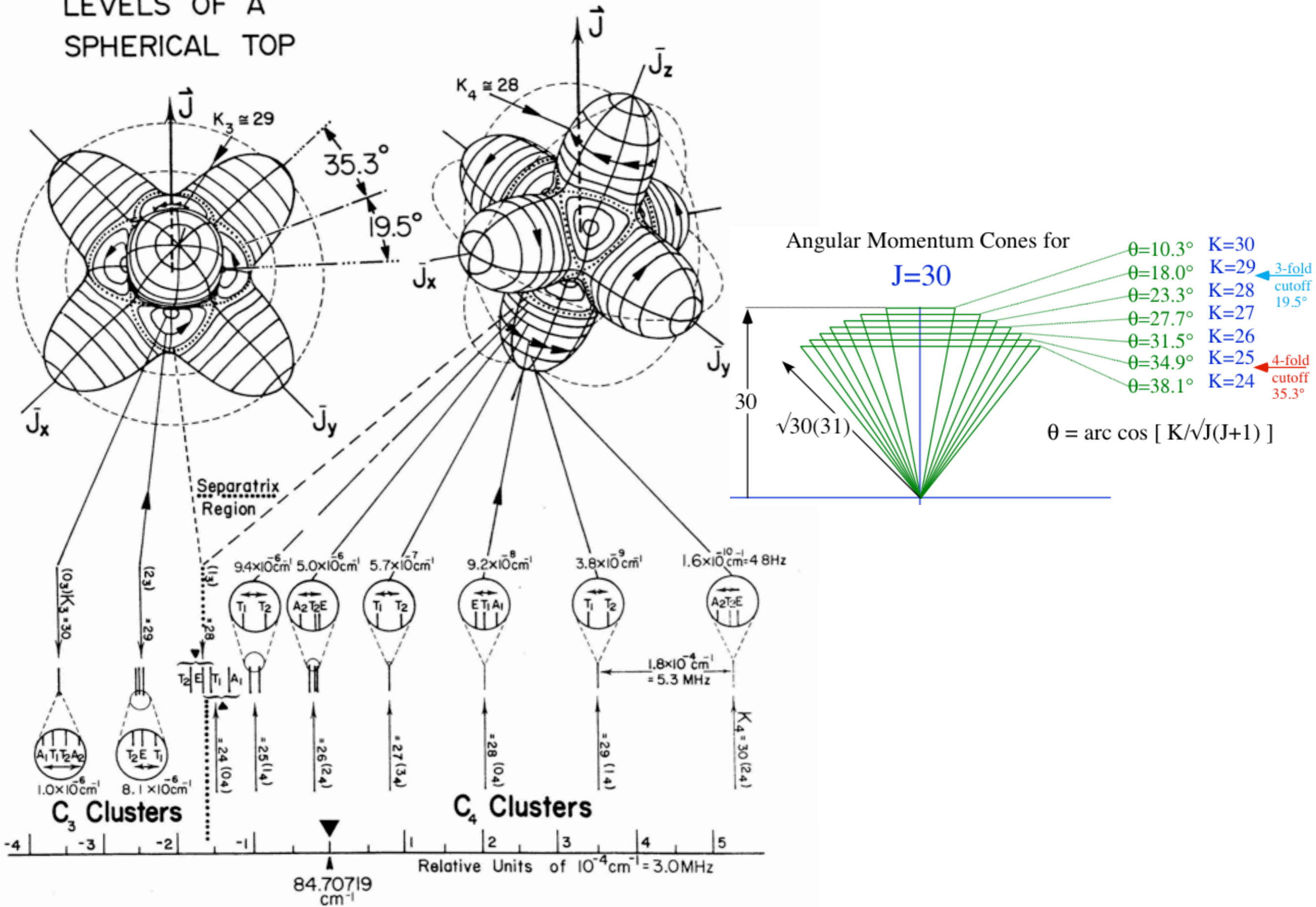

VISUALIZING THE J = 30 LEVELS OF A SPHERICAL TOP

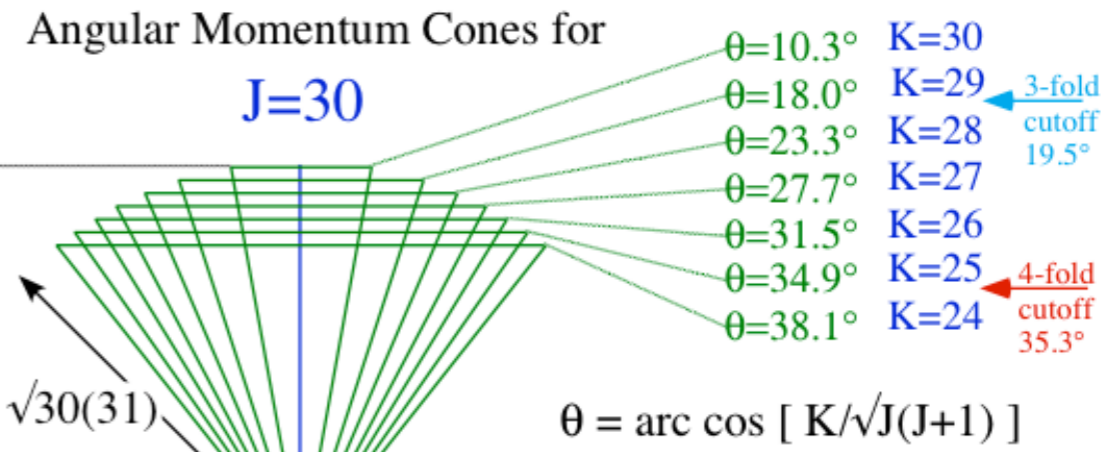
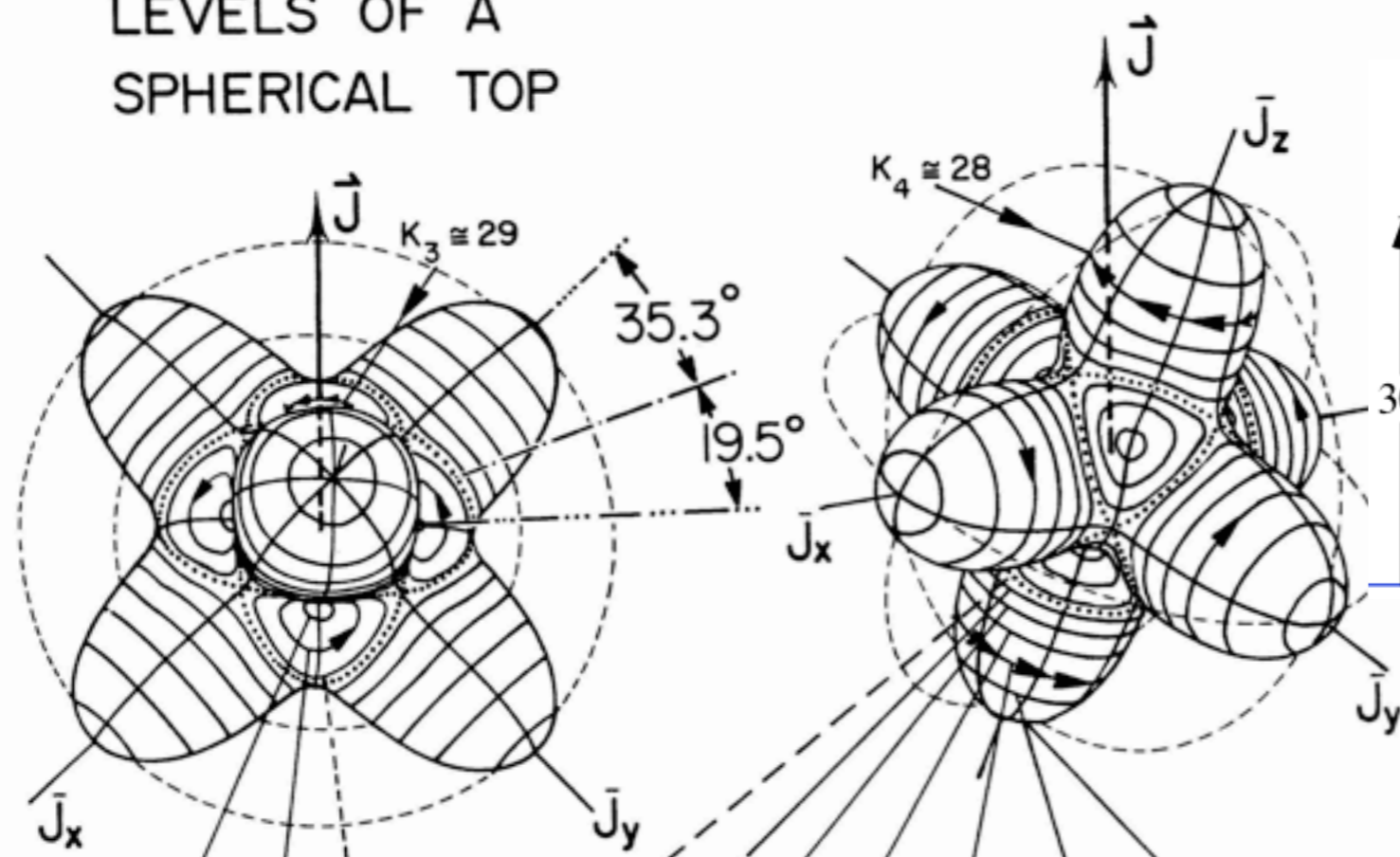

Two molecular examples: *SiF₄* and *C₈H₈*

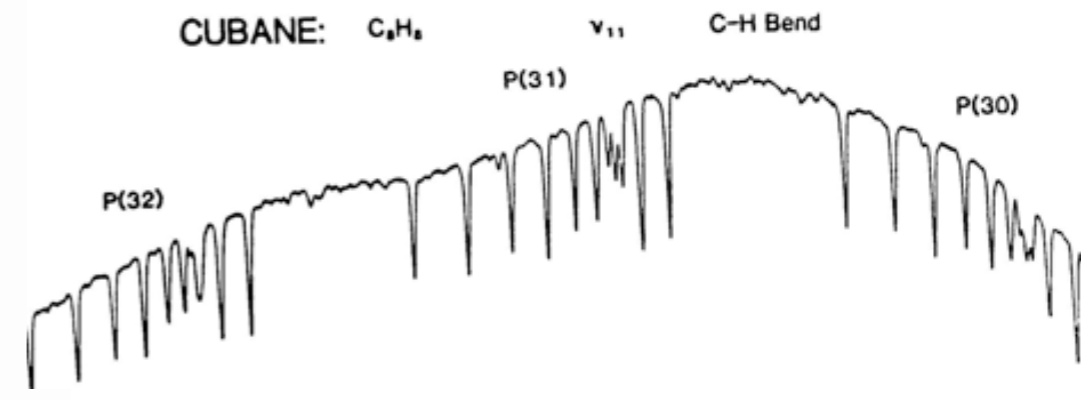
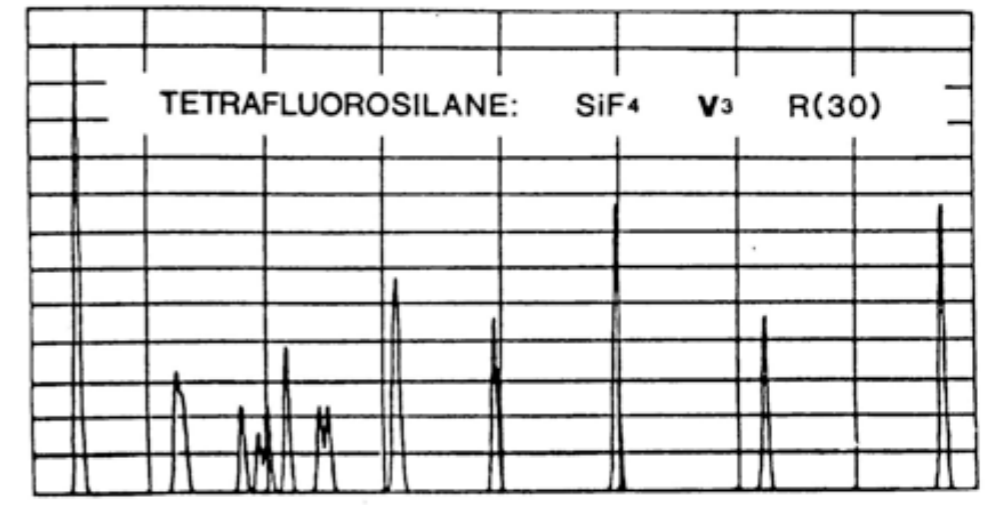
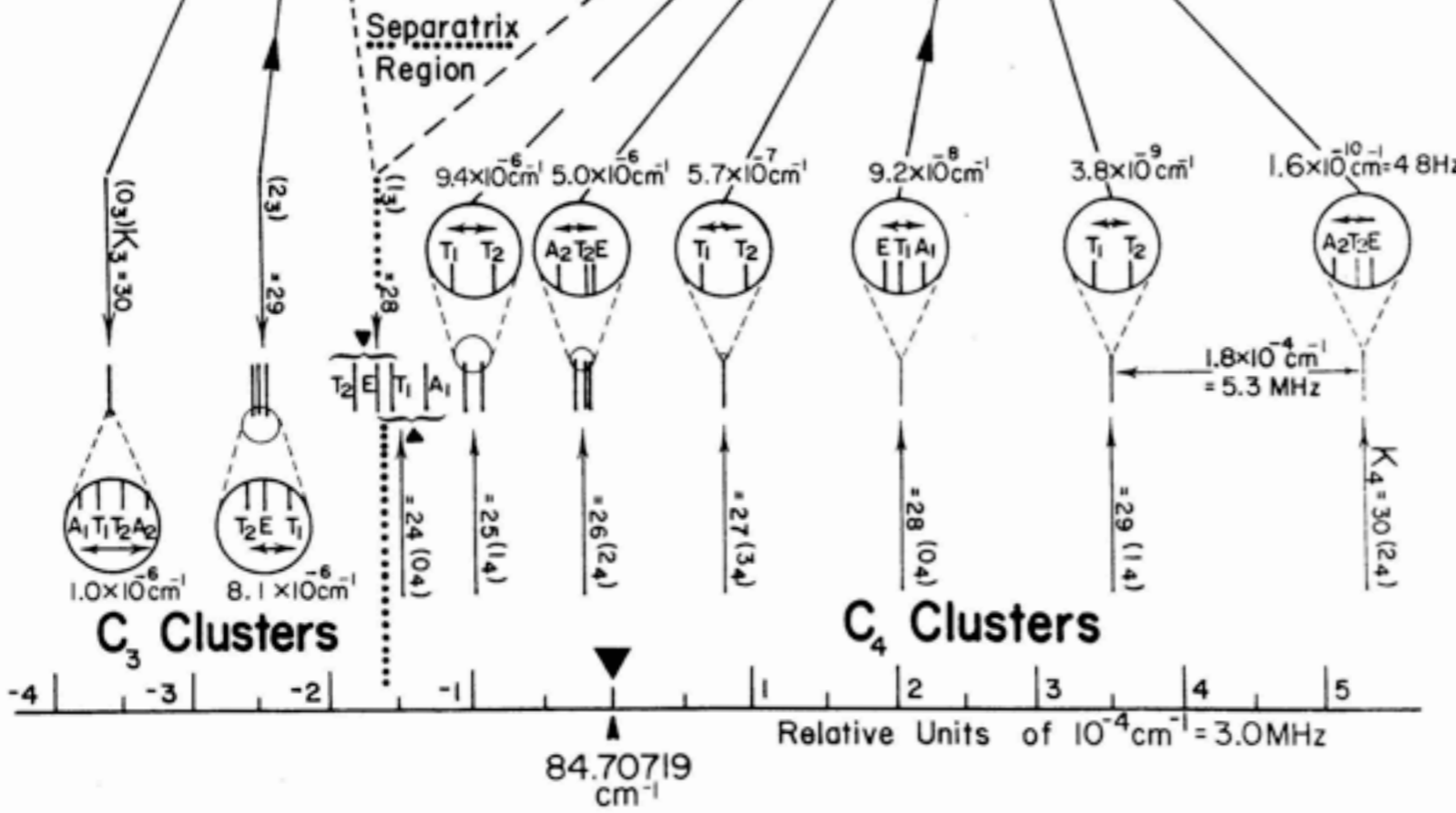

VISUALIZING THE J = 30 LEVELS OF A SPHERICAL TOP

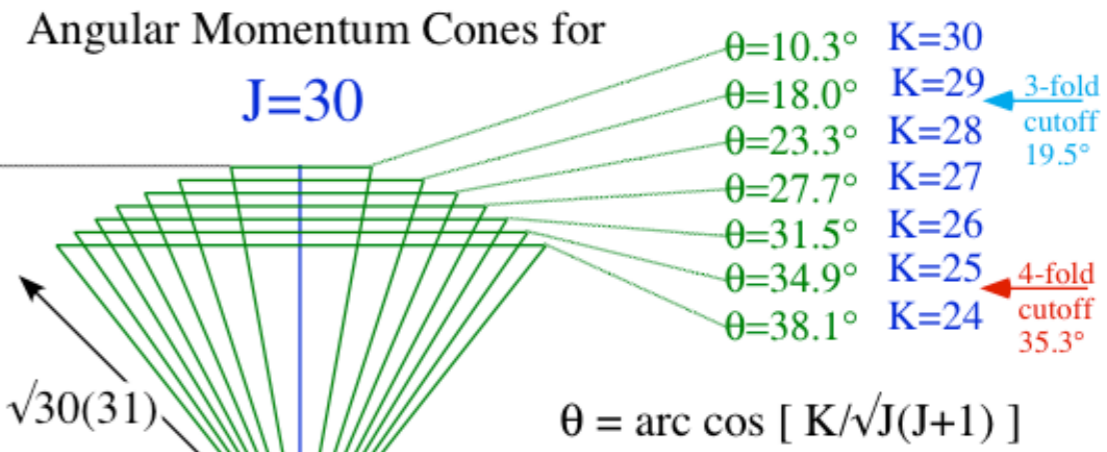
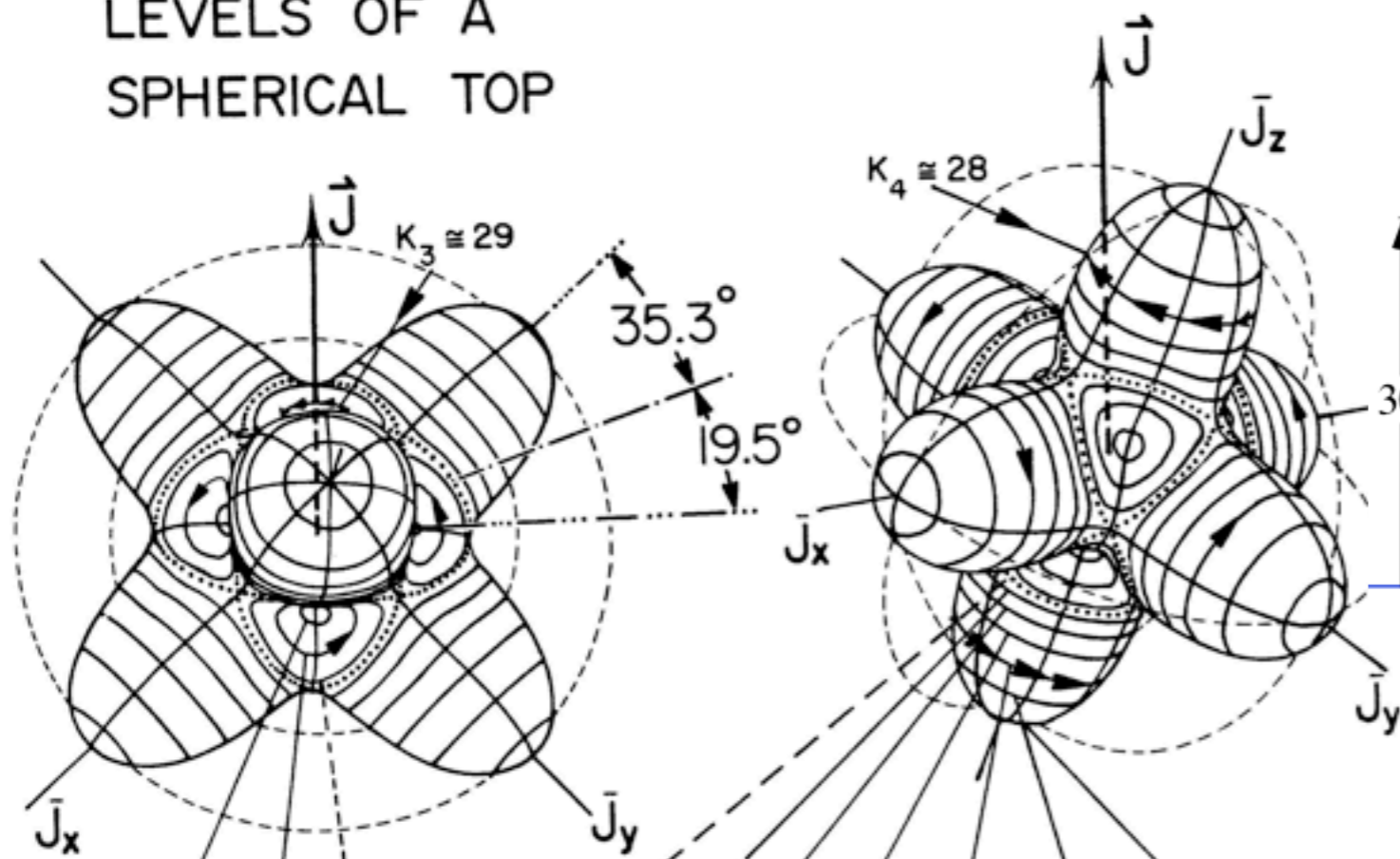

Two molecular examples: *SiF₄* and *C₈H₈*

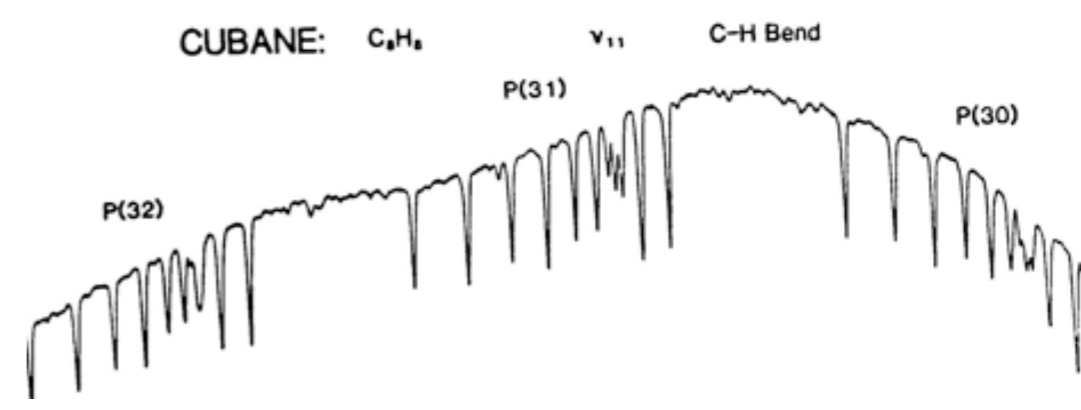
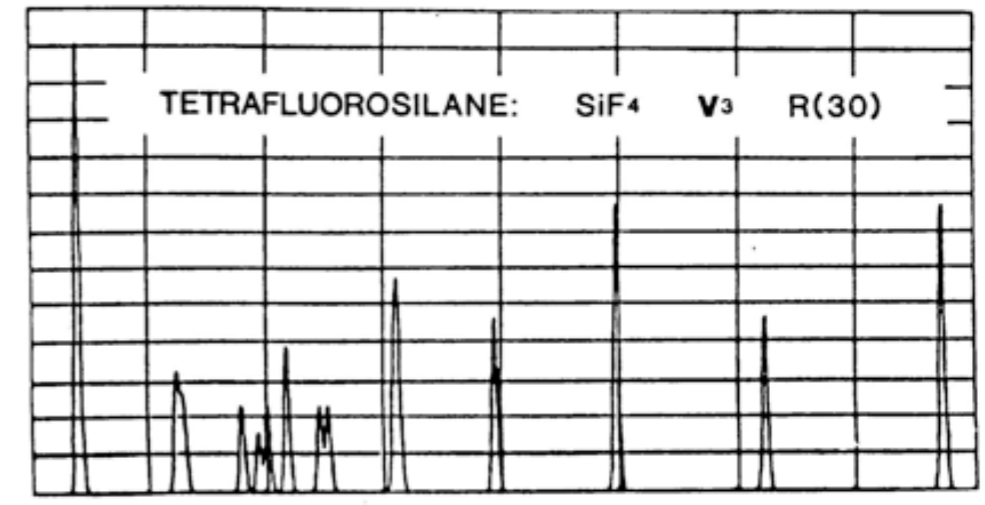
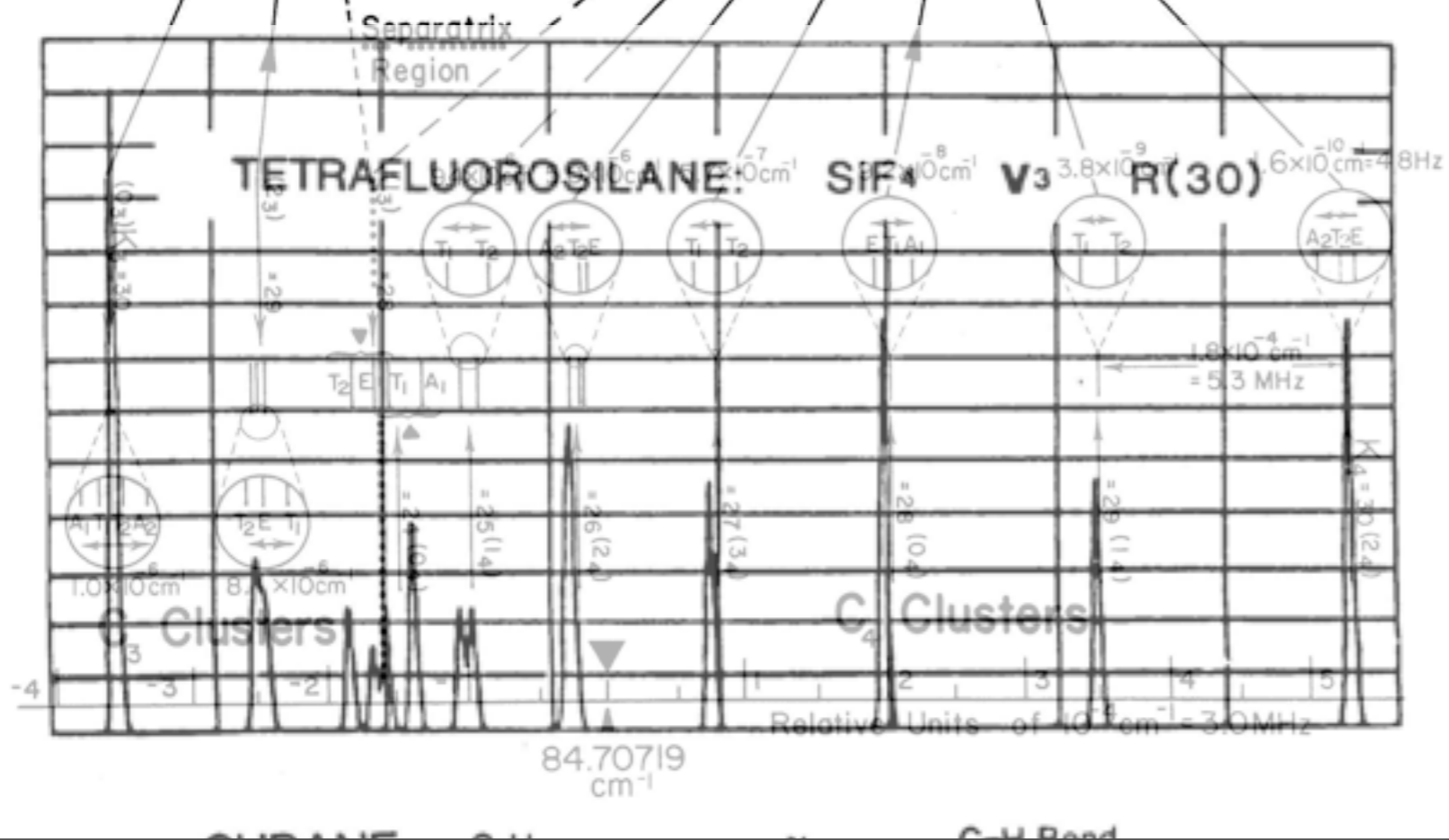

Fig. 25.4.9 Infrared spectra showing fine structure clusters. Tetrafluorosilane (SiF_4) spectrum from a ν_3 R(30) transition ____.
 [After C. W. Patterson, R. S. McDowell, N. G. Nereson, B. J. Krohn, J. S. Wells, and F. R. Peterson, *J. Mol. Spectrosc.* **91**, 416 (1982).
 [Cubane (C_8H_8) spectrum from ν_{11} P(30), P(31), and P(32), transitions; cubane (C_8H_8) spectrum from ν_{12} R(36), transition.
 [After A. S. Pine, A. G. Maki, A. G. Robiette, B. J. Krohn, J. K. G. Watson, and Th Urbanek, *J. Am. Chem. Soc.*, **106**, 891 (1984).]

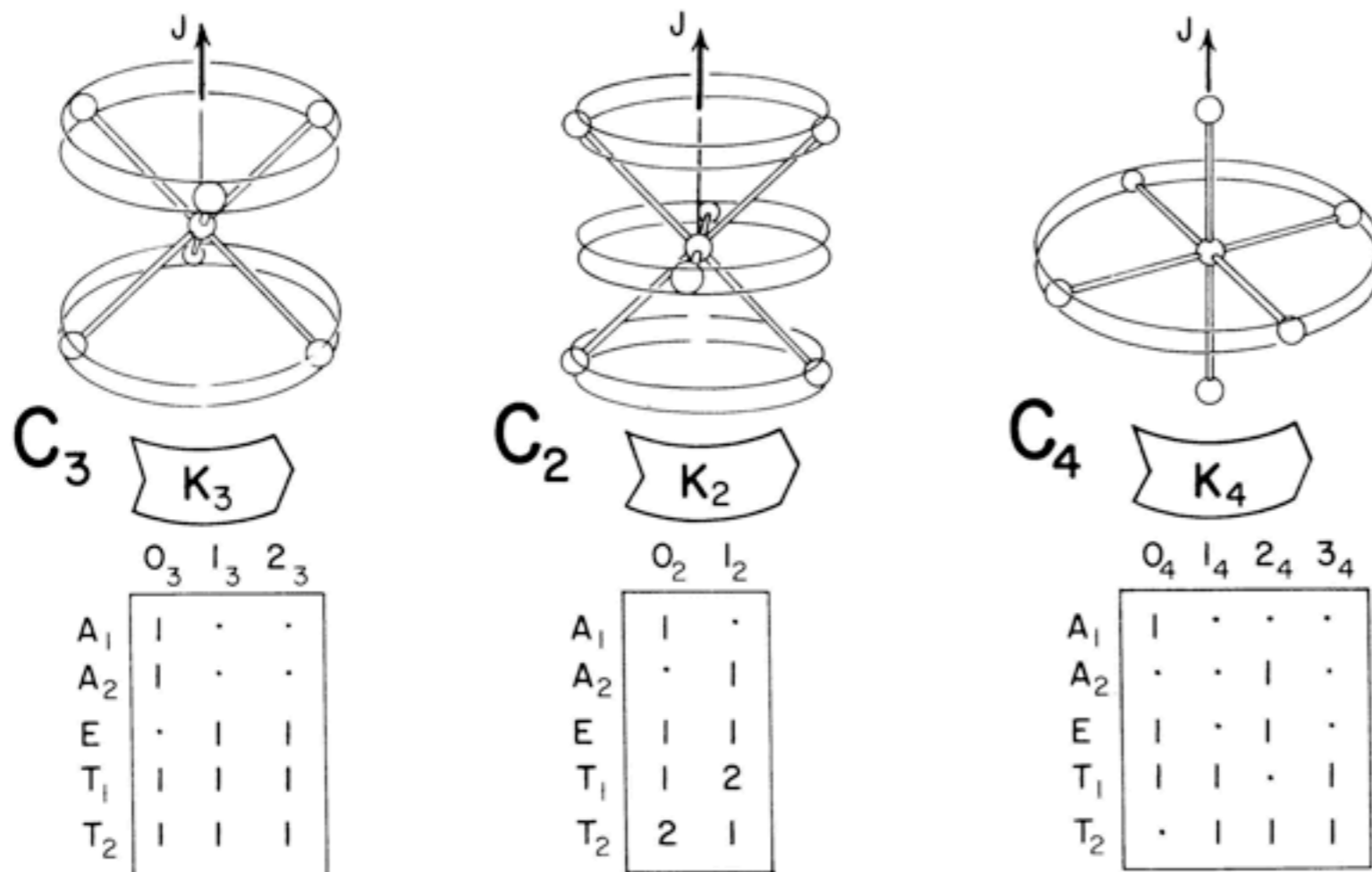

Fig. 25.4.7 Different choices of rotation axes for octahedral rotor corresponding to local symmetry C_3 , C_2 , and C_4 . Tables correlate global octahedral symmetry species with the local ones.

Review :

*Symmetric rigid quantum rotor analysis of $R(2)$ Hamiltonian $\mathbf{H} = B\mathbf{J}_x^2 + B\mathbf{J}_y^2 + C\mathbf{J}_z^2$
Rotational Energy Surfaces (RE or RES) and $R(3) \sim U(2)$ representations*

*Asymmetric rigid quantum rotor analysis of D_2 Hamiltonian $\mathbf{H} = A\mathbf{J}_x^2 + B\mathbf{J}_y^2 + C\mathbf{J}_z^2$
RES and Multipole \mathbf{T}_q^k tensor expansions*

Atomic or molecular $R(3)$ ℓ -level or $2\ell+1$ -multiplet splitting (Review of D_3)

$R(3) \supset D_2$ character analysis of ℓ -level or $2\ell+1$ -multiplet splitting in D_2

Detailed angular momentum operator analysis for $J=1-2$ for D_2 symmetry

Asymmetric rotor levels and RES plots for high- J

Octahedral semi-rigid quantum rotor analysis of O_h Hamiltonian $\mathbf{H} = B\mathbf{J} \cdot \mathbf{J} + t_{044}\mathbf{T}^{[4]}$

Spherical rotor levels and RES plots of O_h tensor eigenvalues

$R(3) \subset O(3) \supset O_h \supset O$ character analysis of ℓ -level or $2\ell+1$ -multiplet splitting in O

Visualizing $J=30$ quantum levels of cubic, octahedral, and tetrahedral molecules

SF_6 spectral fine structure P(88)

CF_4 spectral fine structure P(54)

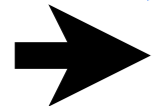

(a) SF₆ ν₄ Rotational Structure

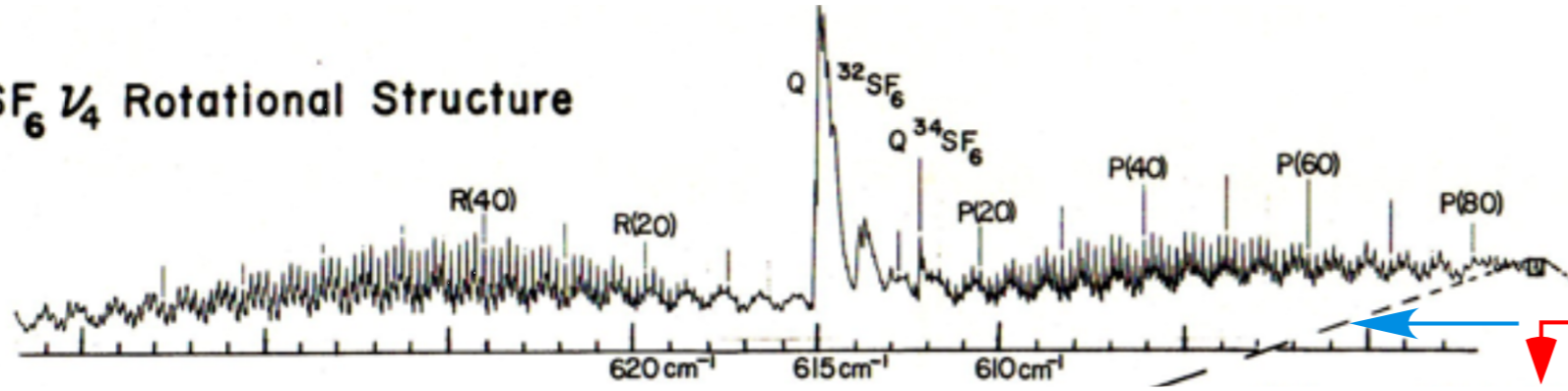

FT IR and Laser Diode Spectra
K.C. Kim, W. B. Person, D. Seitz, and B.J. Krohn
J. Mol. Spectrosc. **76**, 322 (1979).

(a) SF₆ ν₄ Rotational Structure

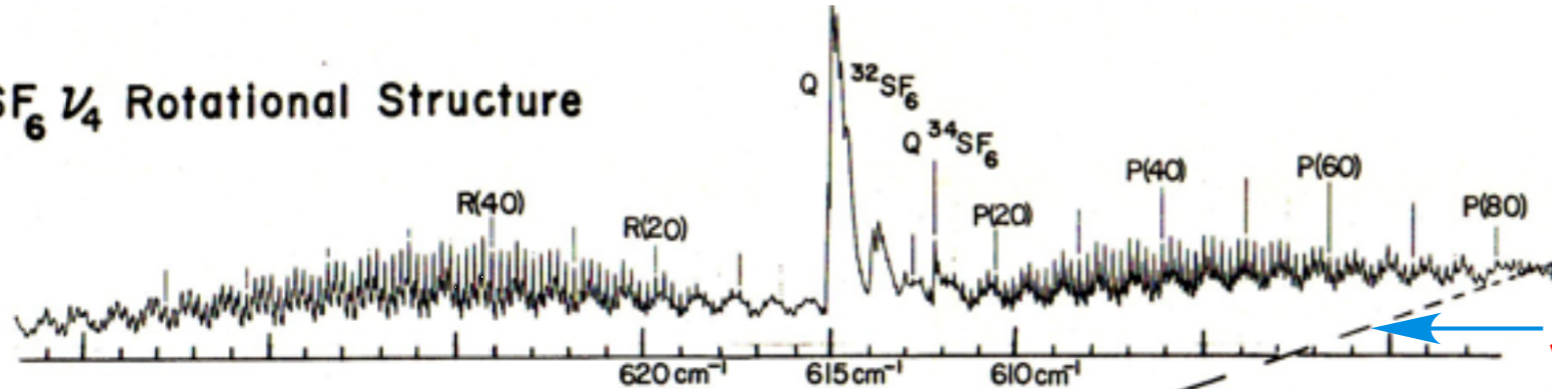

FT IR and Laser Diode Spectra
K.C. Kim, W. B. Person, D. Seitz, and B.J. Krohn
J. Mol. Spectrosc. 76, 322 (1979).

Primary AET species mixing
increases with distance from
"separatrix"

(b) P(88) Fine Structure (Rotational anisotropy effects)

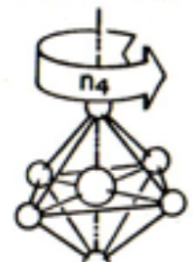

Four fold axis

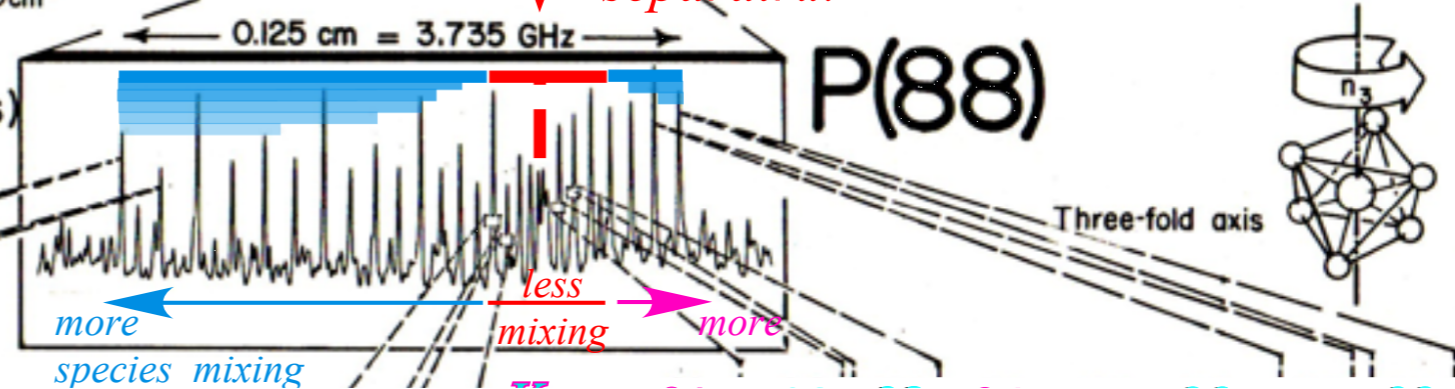

Three-fold axis

more species mixing

less mixing

more

(a) SF₆ ν_4 Rotational Structure

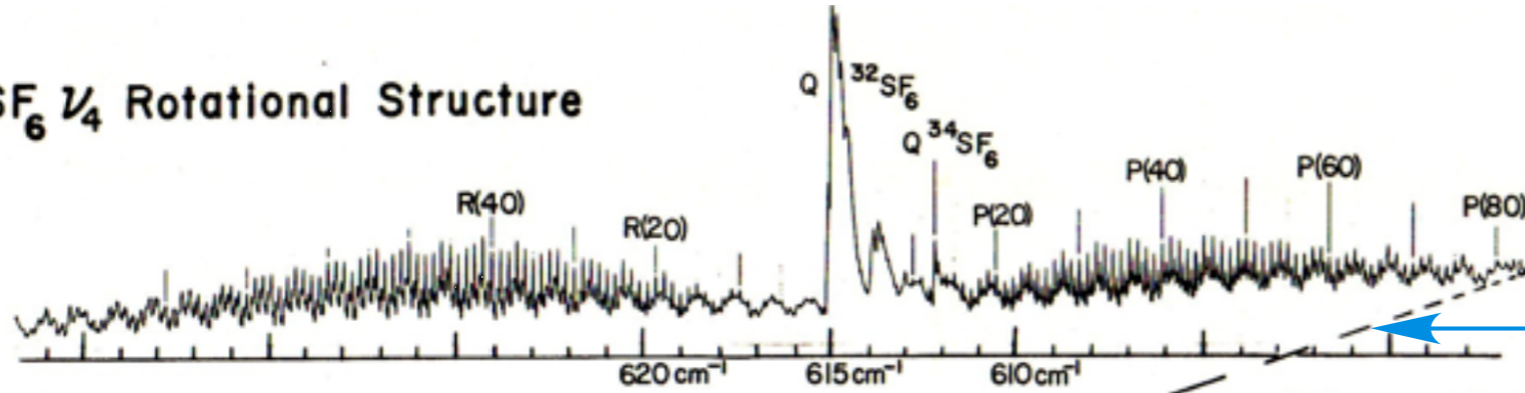

FT IR and Laser Diode Spectra
K.C. Kim, W.B. Person, D. Seitz, and B.J. Krohn
J. Mol. Spectrosc. 76, 322 (1979).

Primary AET species mixing
increases with distance from
"separatrix"

(b) P(88) Fine Structure (Rotational anisotropy effects)

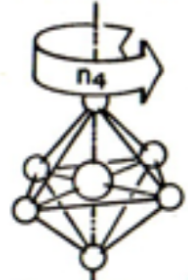

Four fold axis

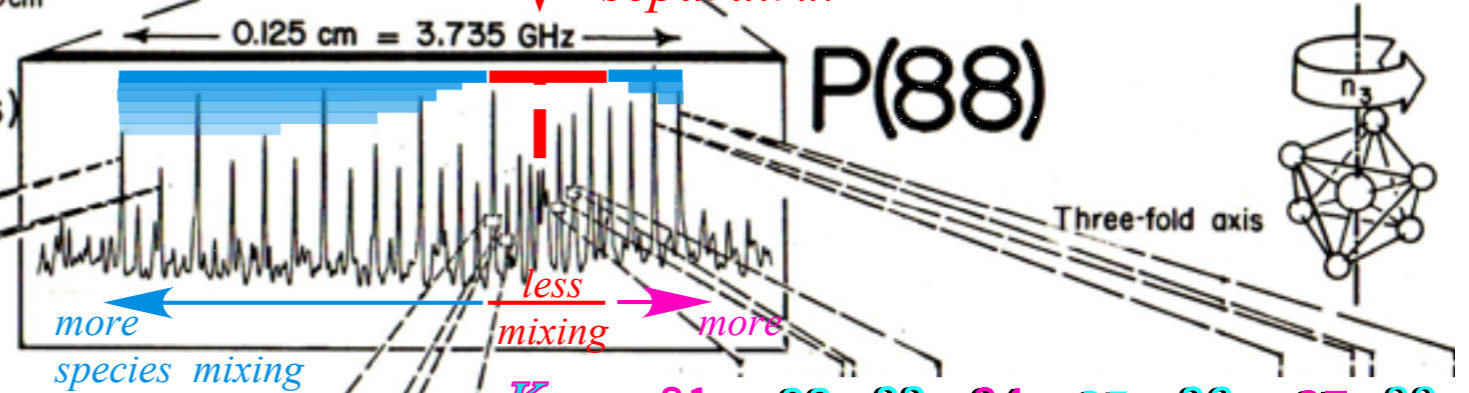

P(88)

Three-fold axis

(c) Superfine Structure (Rotational axis tunneling)

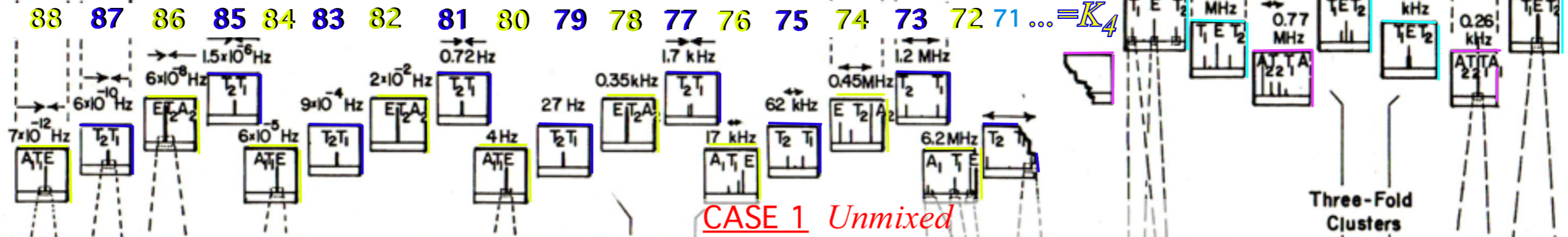

(a) SF₆ ν_4 Rotational Structure

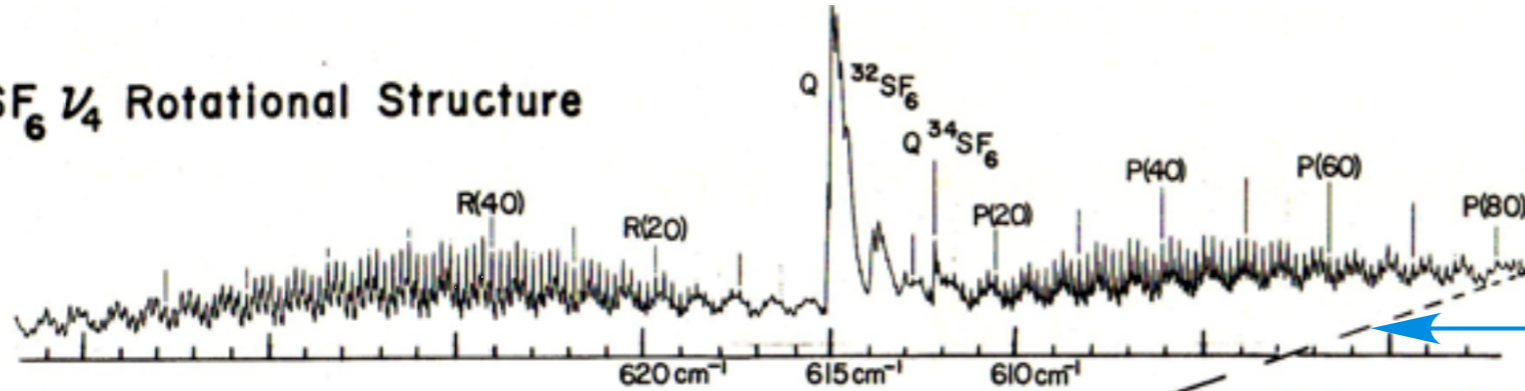

FT IR and Laser Diode Spectra
K.C. Kim, W.B. Person, D. Seitz, and B.J. Krohn
J. Mol. Spectrosc. 76, 322 (1979).

Primary AET species mixing increases with distance from "separatrix"

(b) P(88) Fine Structure (Rotational anisotropy effects)

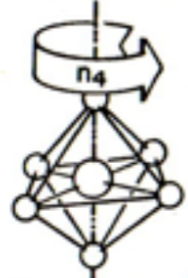

Four fold axis

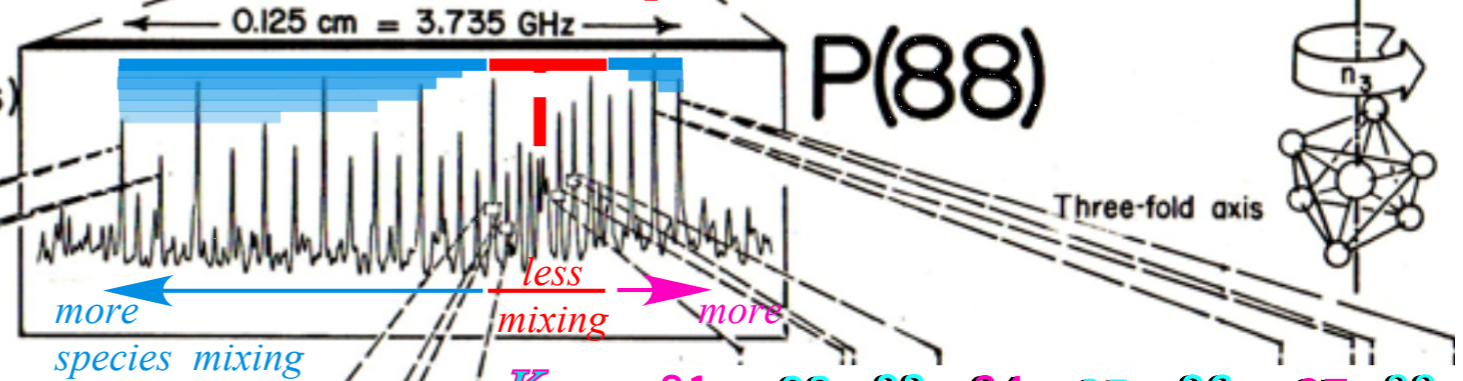

P(88)

Three-fold axis

(c) Superfine Structure (Rotational axis tunneling)

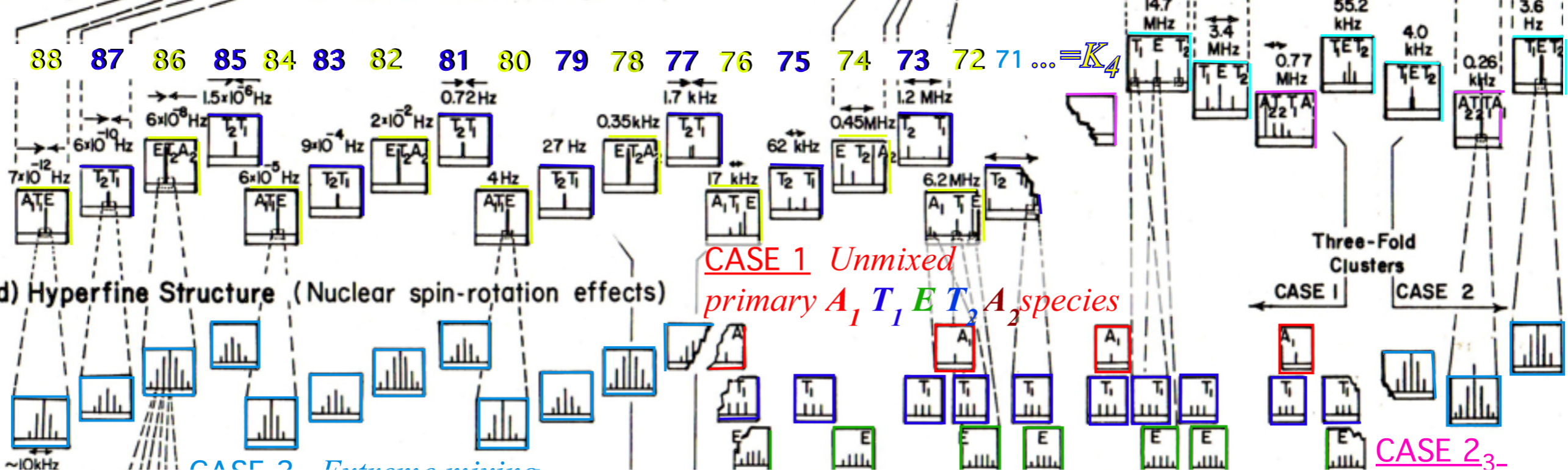

CASE 1 Unmixed primary A₁ T₁ E T₂ A₂ species

CASE 2₃

(d) Hyperfine Structure (Nuclear spin-rotation effects)

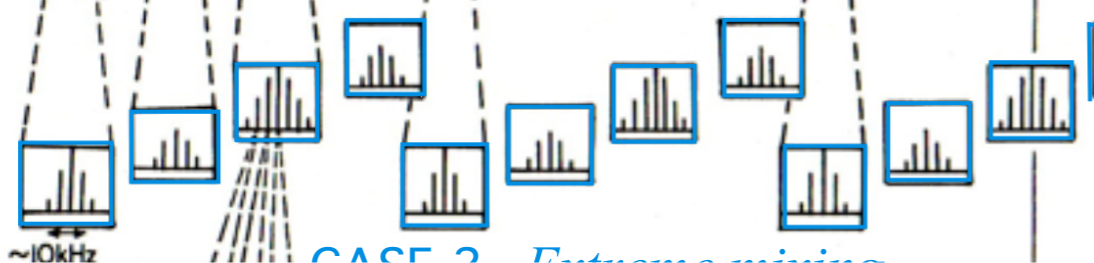

(a) SF₆ 1/4 Rotational Structure

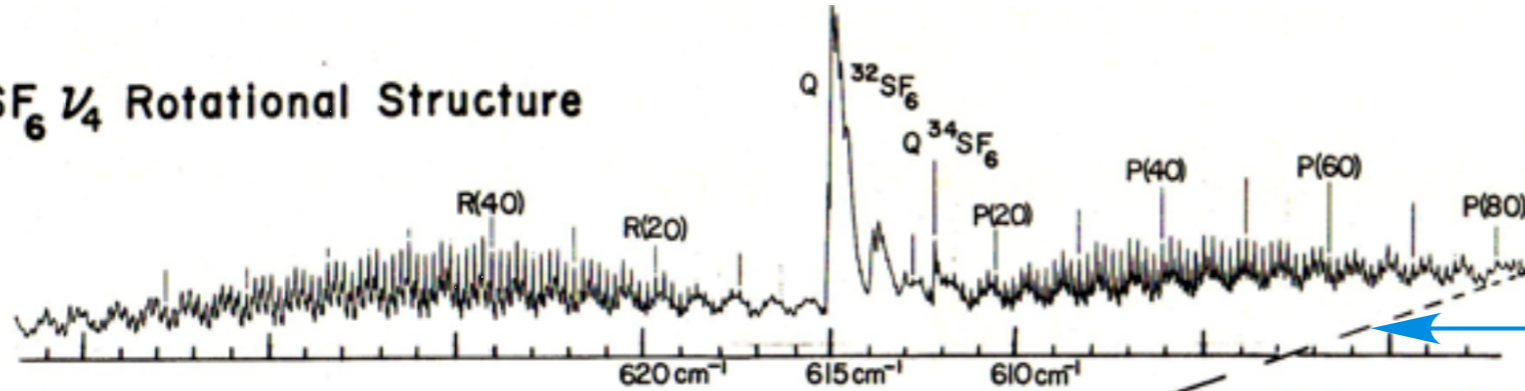

Primary AET species mixing increases with distance from "separatrix"

(b) P(88) Fine Structure (Rotational anisotropy effects)

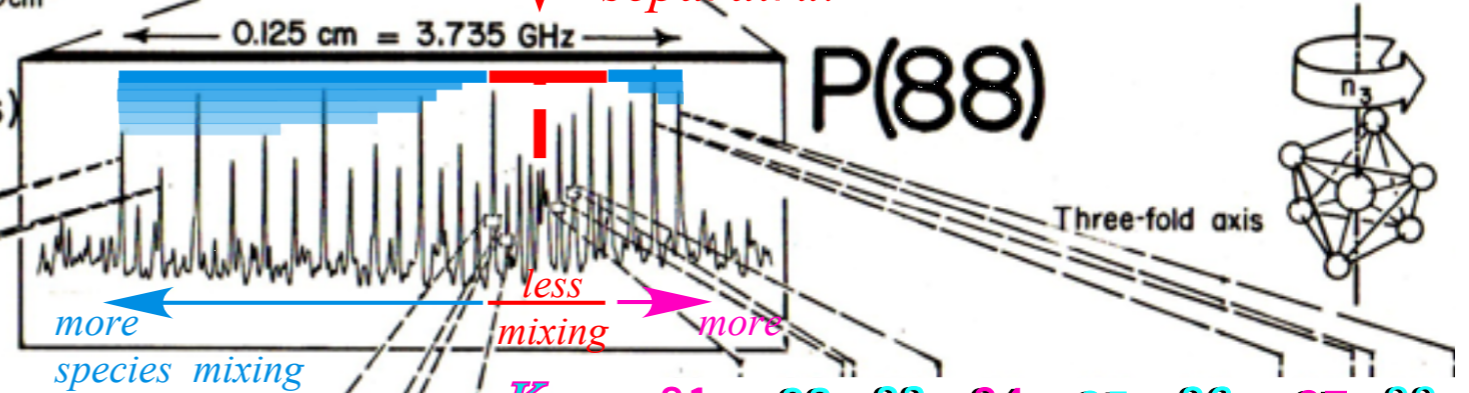

(c) Superfine Structure (Rotational axis tunneling)

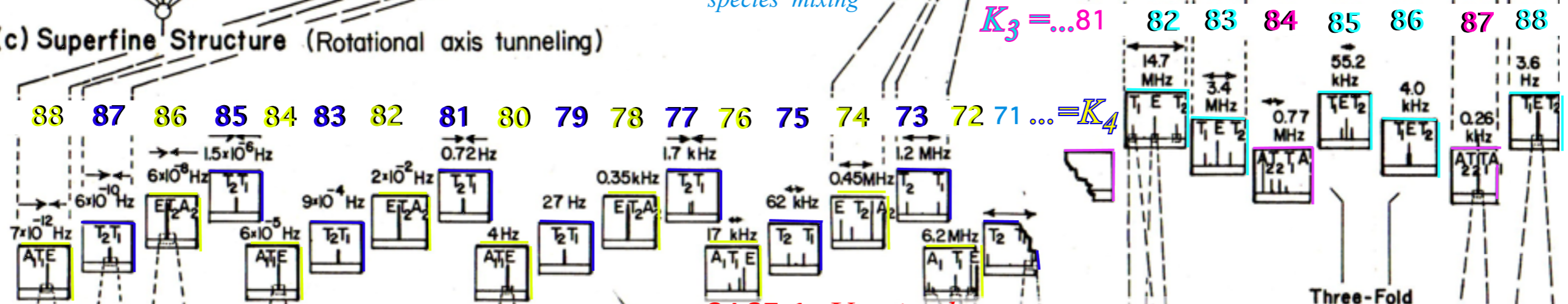

(d) Hyperfine Structure (Nuclear spin-rotation effects)

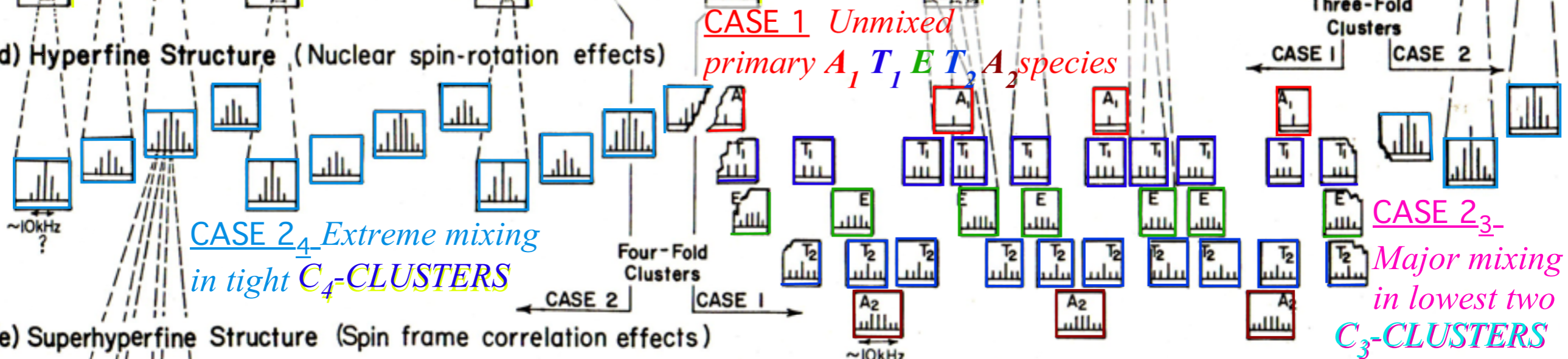

(e) Superhyperfine Structure (Spin frame correlation effects)

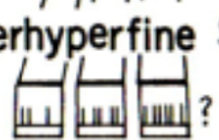

(Next page: approximate theory)

IR Spectra of SF6 ν_4 P(88)

FT IR and Laser Diode Spectra
 K.C. Kim, W.B. Person, D. Seitz, and B.J. Krohn
 J.Mol. Spectrosc. 76, 322 (1979).

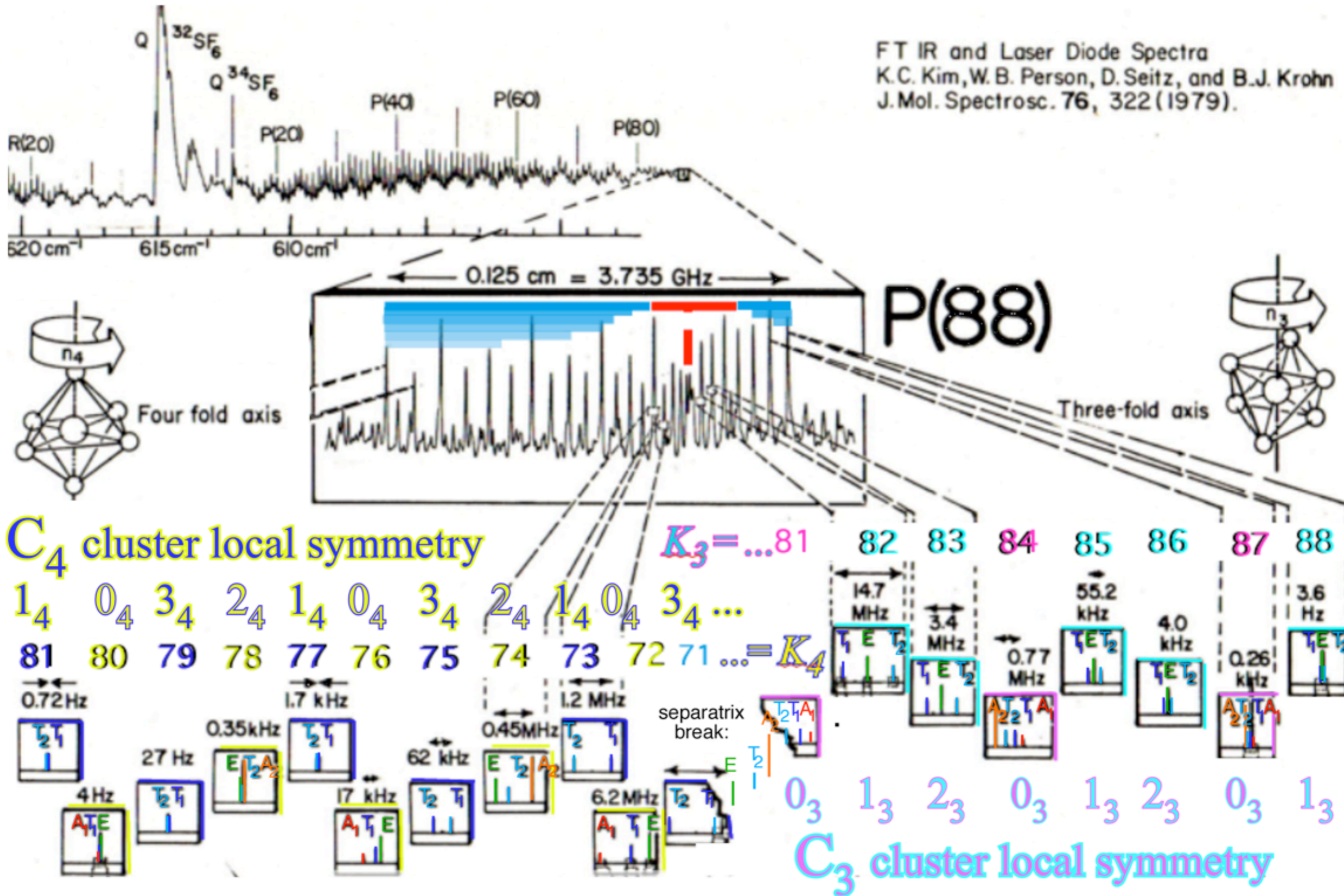

Int.J.Molecular Science 14.(2013) Fig.26 p. 783

SF₆ Spectra of O_h Ro-vibronic Hamiltonian described by RE Tensor Topography and J-cone intersection

$$\begin{aligned}
 \mathbf{H} &= B(\mathbf{J}_x^2 + \mathbf{J}_y^2 + \mathbf{J}_z^2) + t_{440} \left(\mathbf{J}_x^4 + \mathbf{J}_y^4 + \mathbf{J}_z^4 - \frac{3}{5} J^4 \right) + \dots \\
 &= B\mathbf{J}^2 + t_{440} \left(\mathbf{T}_0^4 + \sqrt{\frac{5}{14}} [\mathbf{T}_4^4 + \mathbf{T}_{-4}^4] \right) + \dots
 \end{aligned}$$

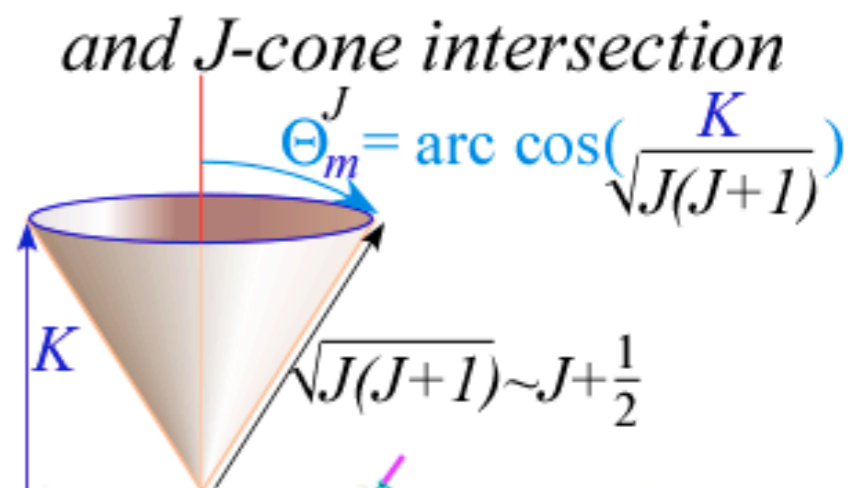

Rovibronic Energy (RE) Tensor Surface

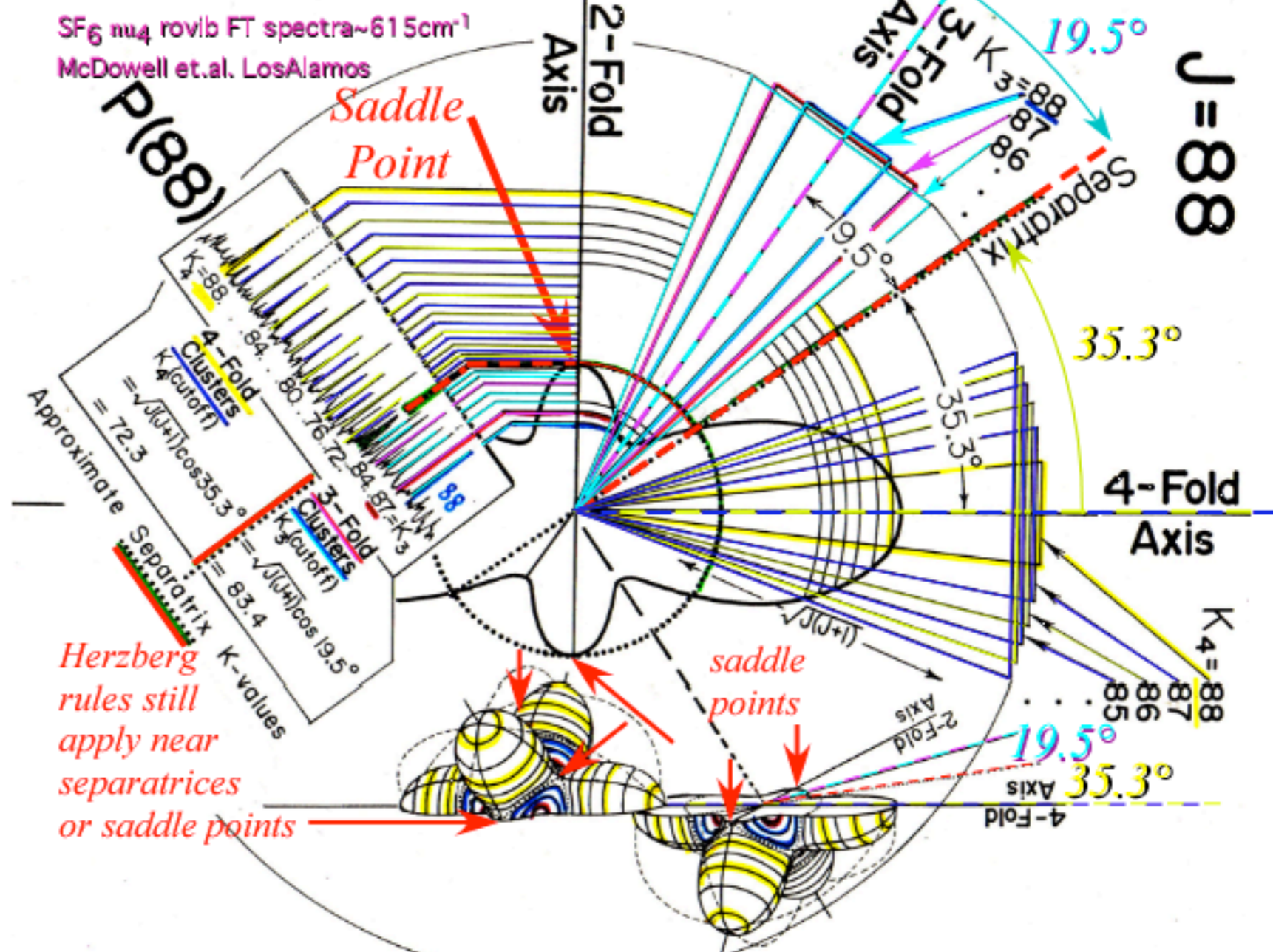
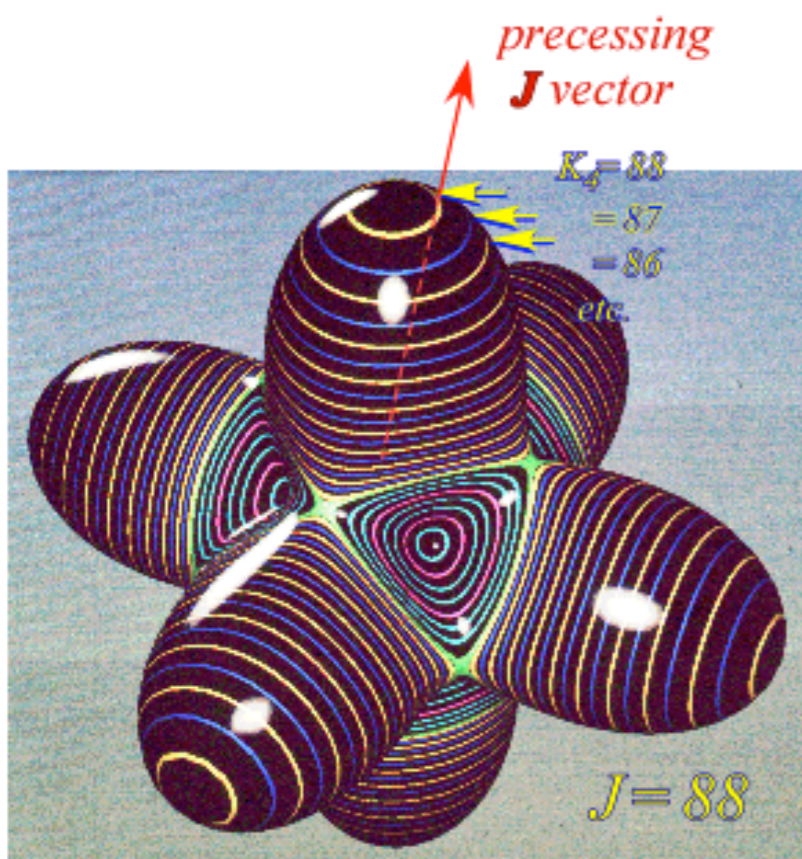

(a) SF₆ ν₄ Rotational Structure

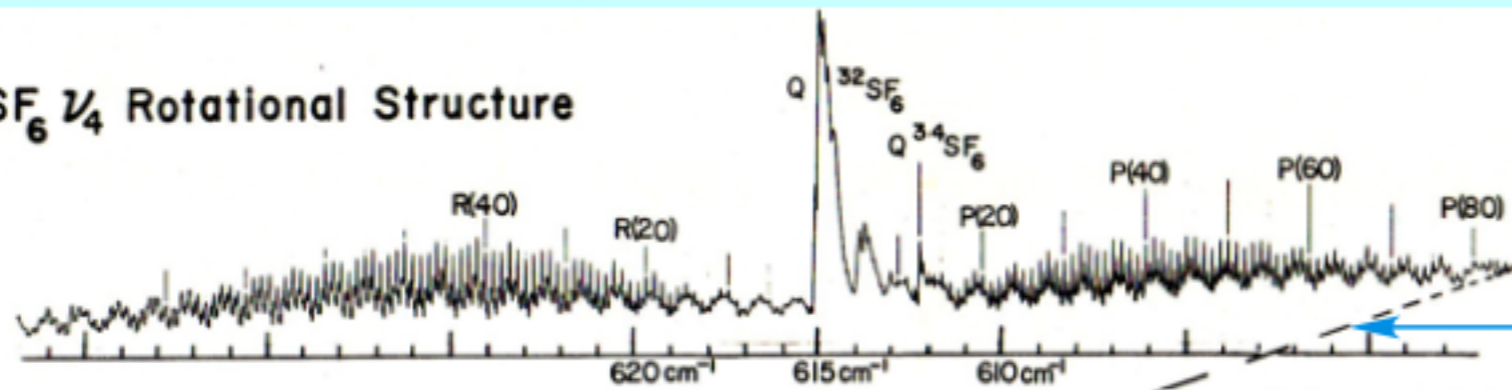

FT IR and Laser Diode Spectra
K.C. Kim, W.B. Person, D. Seitz, and B.J. Krohn
J. Mol. Spectrosc. 76, 322 (1979).

Primary AET species mixing increases with distance from "separatrix"

(b) P(88) Fine Structure (Rotational anisotropy effects)

SF₆ ν₃ P(88) ~ 16m



Four fold axis

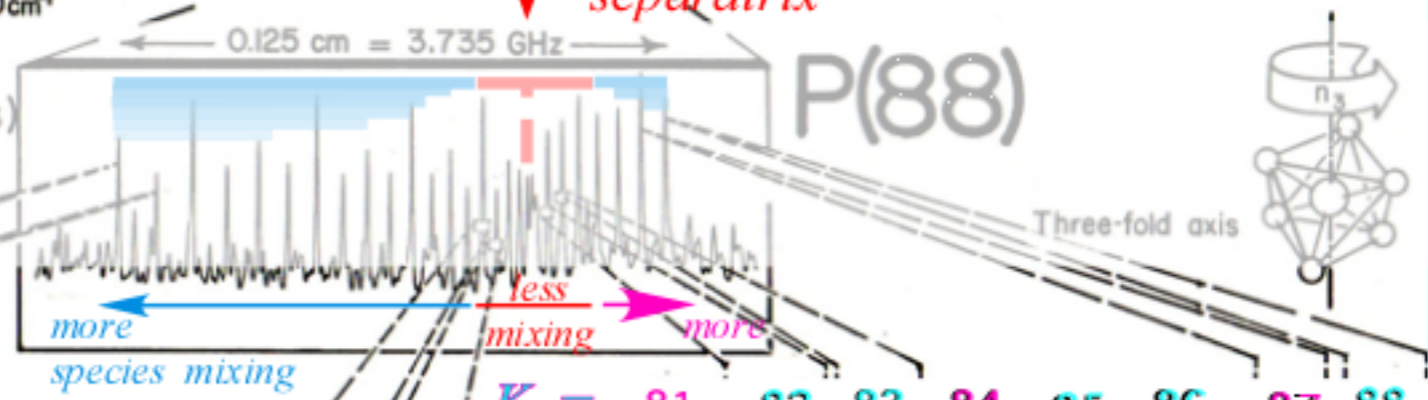

Three-fold axis

(c) Superfine Structure (Rotational axis tunneling)

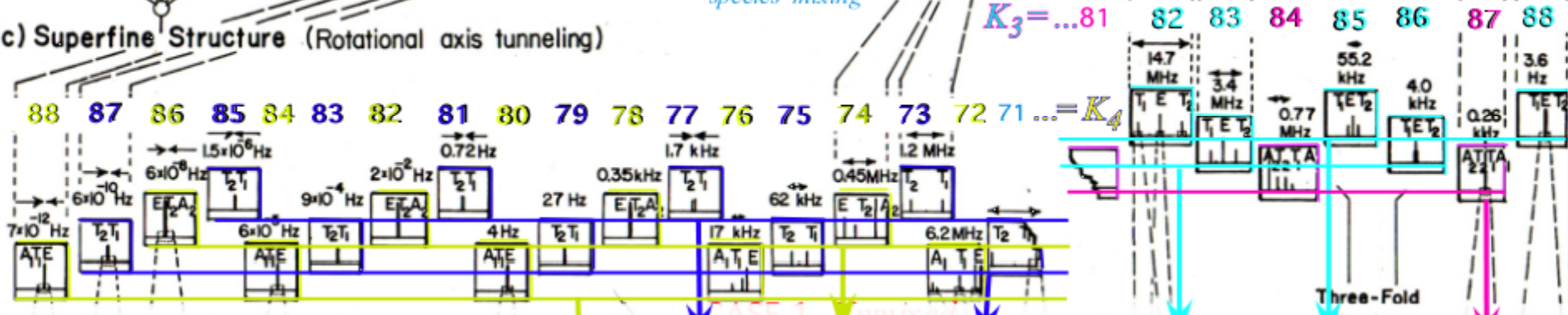

Observed repeating sequence(s) .. A₁ T₁ E T₂ T₁ E T₂ A₂ T₂ T₁ A₁ T₁ E T₂ T₁ E T₂ A₂ T₂ T₁ A₁ ..

O=C₄ (0)₄ (1)₄ (2)₄ (3)₄ = (-1)₄

O=C₃ (0)₃ (1)₃ (2)₃ = (-1)₃

Local correlations explain clustering...
... but what about spacing and ordering?...

...and physical consequences?

A ₁	1	•	•	•
A ₂	•	•	1	•
E	1	•	1	•
T ₁	1	1	•	1
T ₂	•	1	1	1

A ₁	1	•	•
A ₂	1	•	•
E	•	1	1
T ₁	1	1	1
T ₂	1	1	1

major mixing lowest two LUSTERS

(e) Superfine Structure (Nuclear spin correlation)

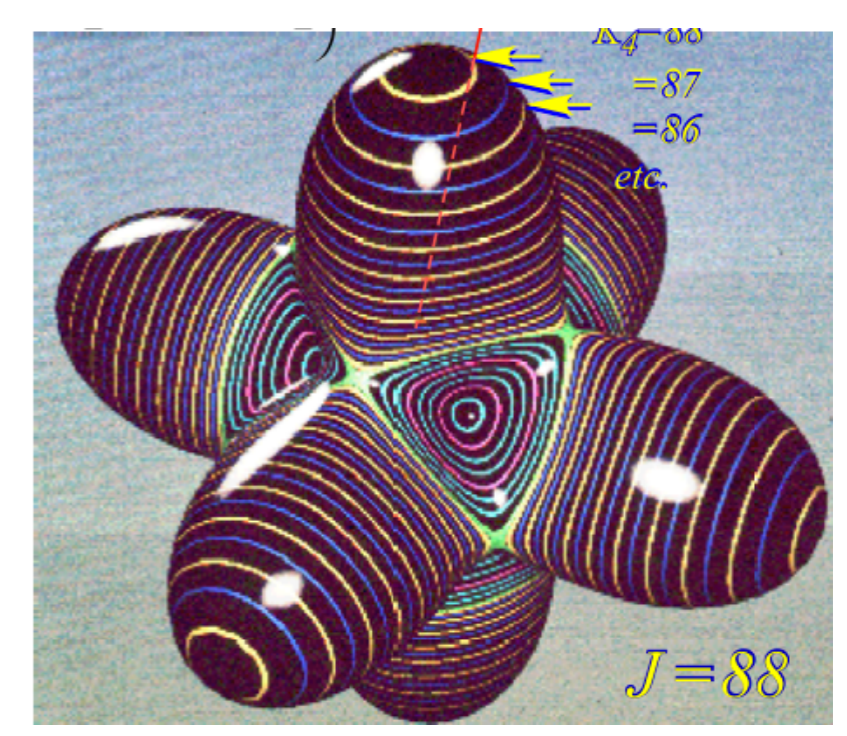
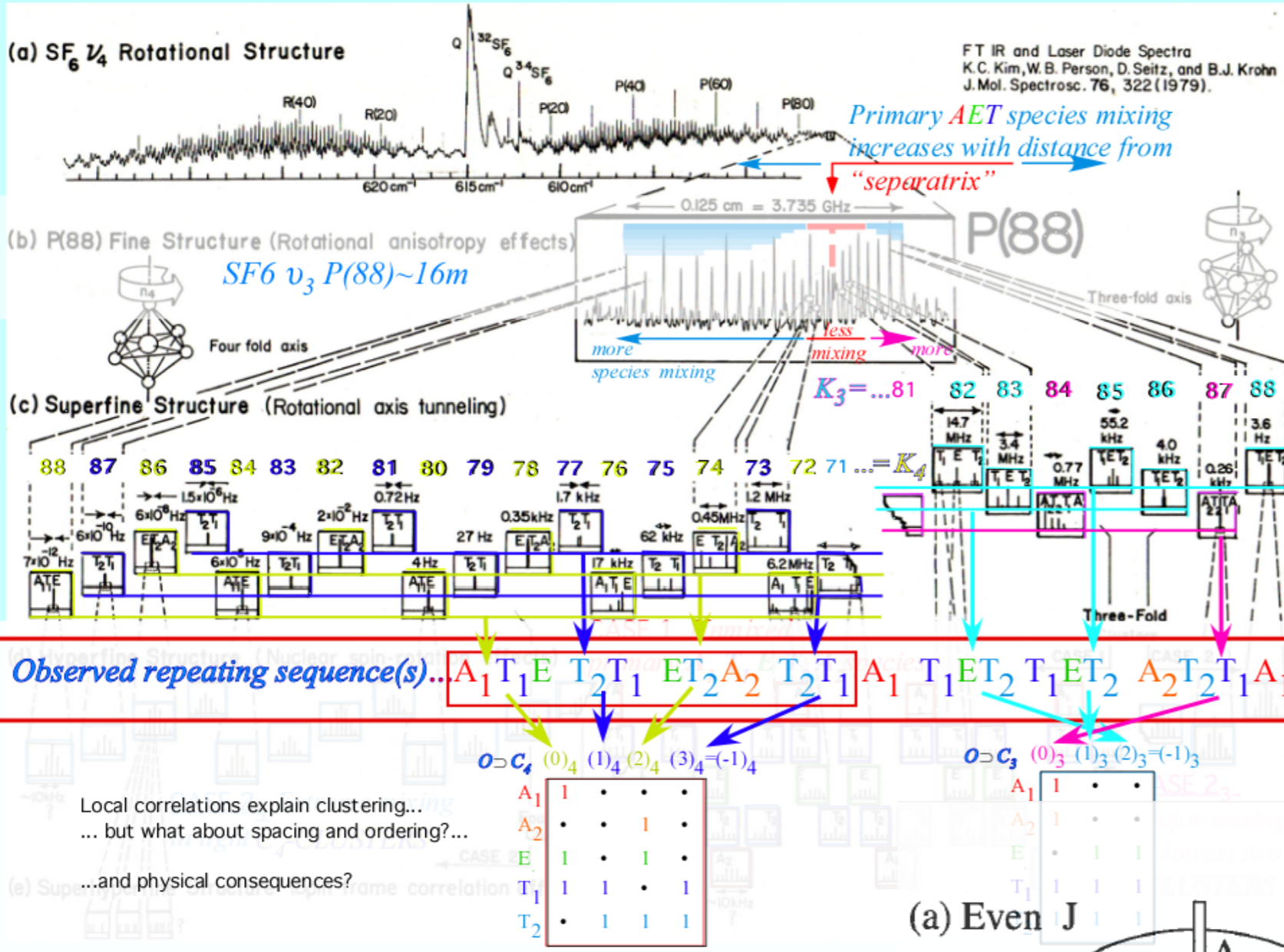

SF₆ spectral fine structure in P(88)
Note that ordering of symmetry species listed on the O-wheel is maintained as they morph from C₄ hill-clusters to C₃ valley-clusters on the low side of the C₂ separatrix.

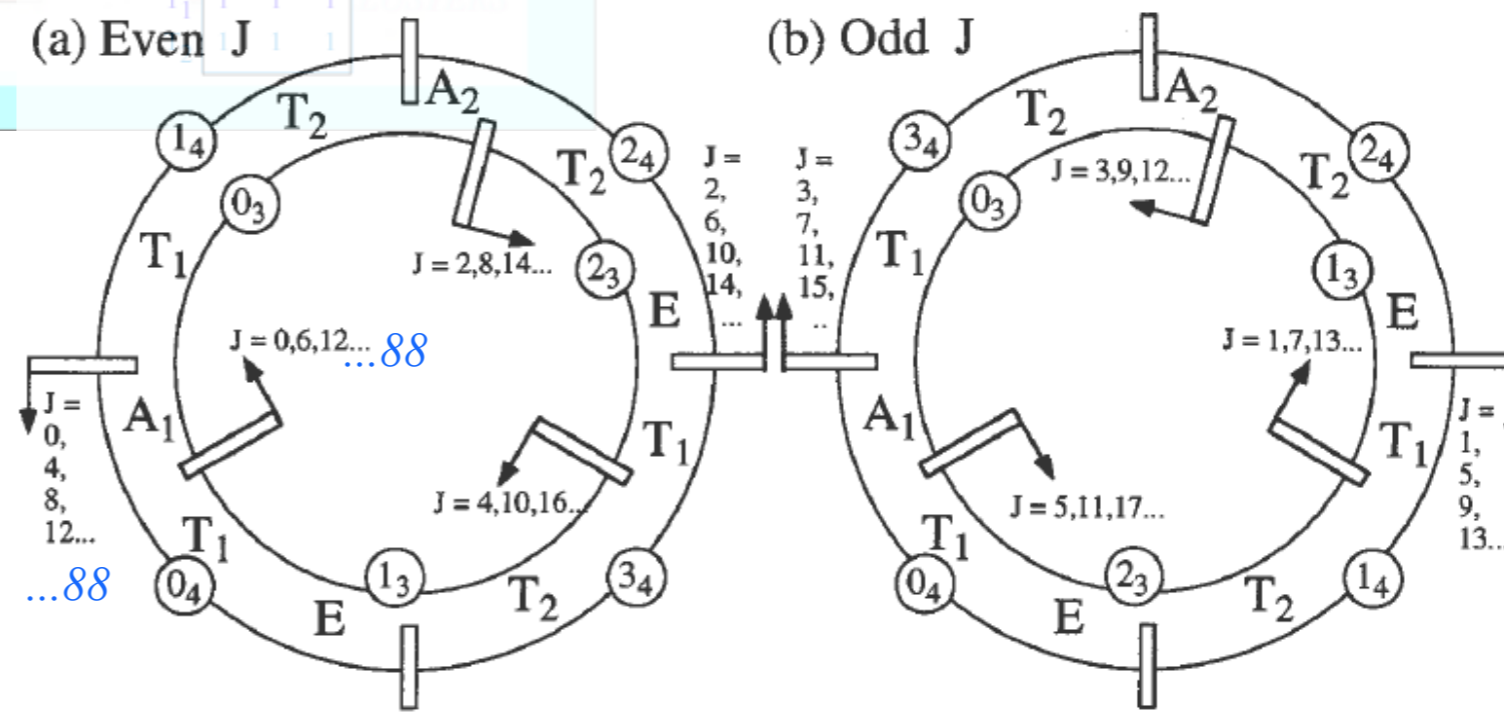

Figure 5.6.9 Mnemonic wheels for octahedral-O orbital. Splitting of J levels for (a) even J and (b) odd J.

Review :

*Symmetric rigid quantum rotor analysis of $R(2)$ Hamiltonian $\mathbf{H} = B\mathbf{J}_x^2 + B\mathbf{J}_y^2 + C\mathbf{J}_z^2$
Rotational Energy Surfaces (RE or RES) and $R(3) \sim U(2)$ representations*

*Asymmetric rigid quantum rotor analysis of D_2 Hamiltonian $\mathbf{H} = A\mathbf{J}_x^2 + B\mathbf{J}_y^2 + C\mathbf{J}_z^2$
RES and Multipole \mathbf{T}_q^k tensor expansions*

Atomic or molecular $R(3)$ ℓ -level or $2\ell+1$ -multiplet splitting (Review of D_3)

$R(3) \supset D_2$ character analysis of ℓ -level or $2\ell+1$ -multiplet splitting in D_2

Detailed angular momentum operator analysis for $J=1-2$ for D_2 symmetry

Asymmetric rotor levels and RES plots for high- J

Octahedral semi-rigid quantum rotor analysis of O_h Hamiltonian $\mathbf{H} = B\mathbf{J} \cdot \mathbf{J} + t_{044}\mathbf{T}^{[4]}$

Spherical rotor levels and RES plots of O_h tensor eigenvalues

$R(3) \subset O(3) \supset O_h \supset O$ character analysis of ℓ -level or $2\ell+1$ -multiplet splitting in O

Visualizing $J=30$ quantum levels of cubic, octahedral, and tetrahedral molecules

SF_6 spectral fine structure P(88)

 *CF_4 spectral fine structure P(54)*



Example of frequency hierarchy
for $16\mu\text{m}$ spectra
of CF_4
(Freon-14)

W.G.Harter

Ch. 31

Atomic, Molecular, &
Optical Physics Handbook

Am. Int. of Physics

Gordon Drake Editor

(1996)

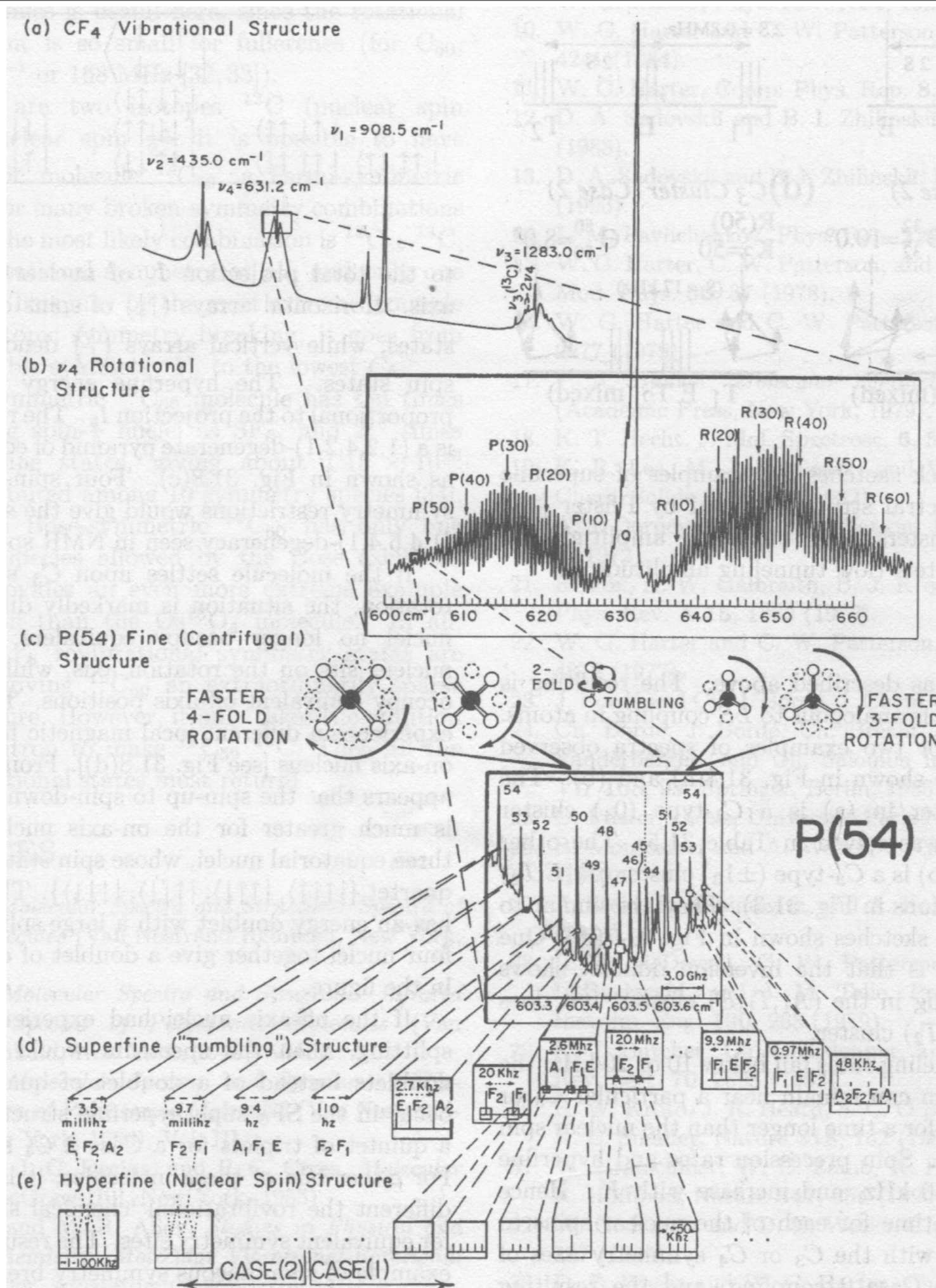

Example of frequency hierarchy for 16 μ m spectra of CF₄ (Freon-14)

W.G.Harter

Fig. 32.7

Springer Handbook of Atomic, Molecular, & Optical Physics
Gordon Drake Editor (2005)

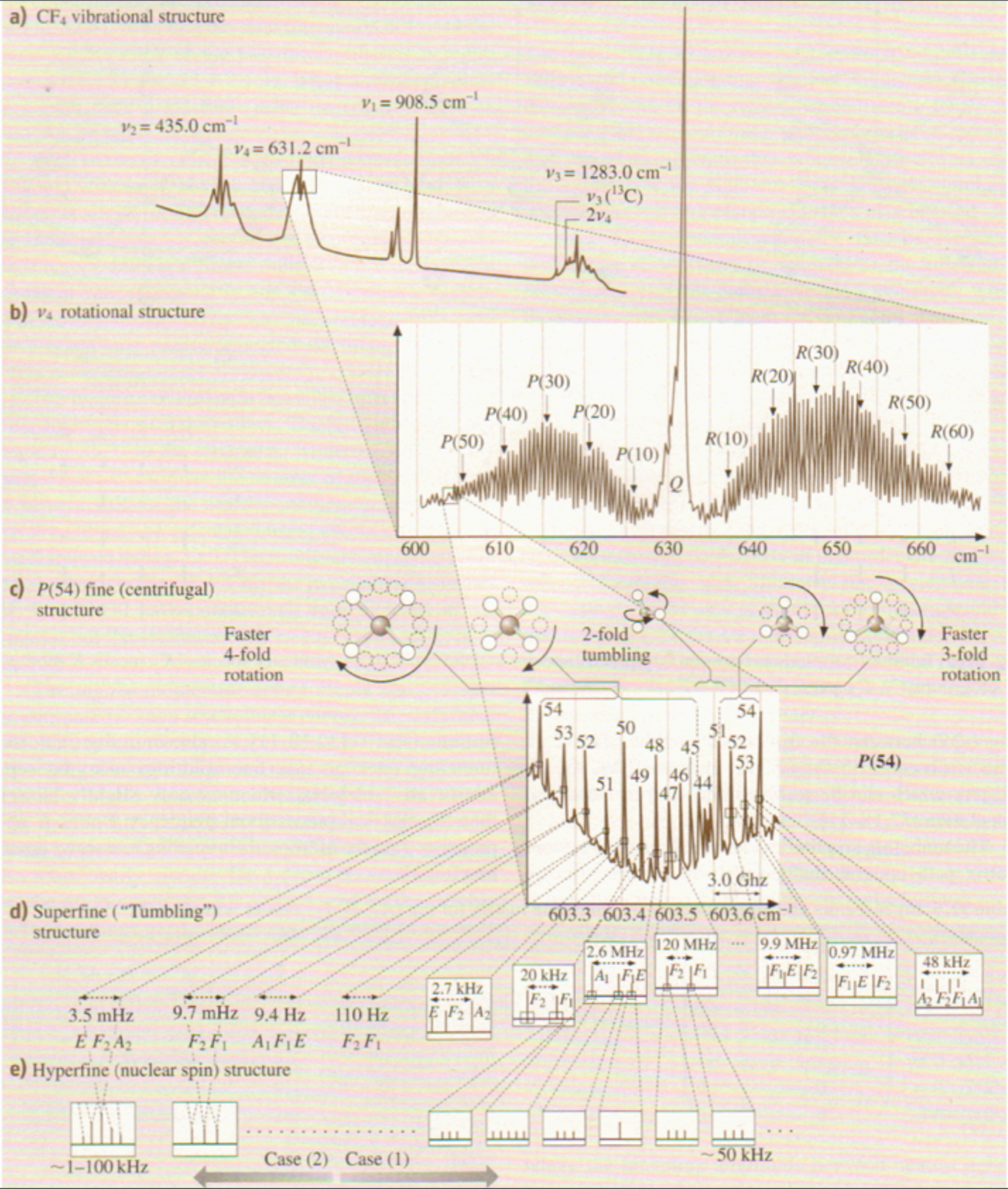

As of April 3, 2014

Links to the current Harter-Soft LearnIt web apps for Physics

Bold links have default redirect pages. *Italics* are not yet meant for production. **Red: the final stages of testing.**

List of *production* Harter-Soft Web Apps & Textbooks (For public)

[Classical Mechanics with a Bang!](http://www.uark.edu/ua/modphys/markup/CMwBangWeb.html) - URL is "<http://www.uark.edu/ua/modphys/markup/CMwBangWeb.html>"
[Quantum Theory for the Computer Age](http://www.uark.edu/ua/modphys/markup/QTCASWeb.html) - URL is "<http://www.uark.edu/ua/modphys/markup/QTCASWeb.html>"
[LearnIt Web Applications](http://www.uark.edu/ua/modphys/markup/LearnItWeb.html) - URL is "<http://www.uark.edu/ua/modphys/markup/LearnItWeb.html>"

Individual web-apps for current classes:

[BohrIt](http://www.uark.edu/ua/modphys/markup/BohrItWeb.html) - Production; URL is "<http://www.uark.edu/ua/modphys/markup/BohrItWeb.html>"
[BounceIt](http://www.uark.edu/ua/modphys/markup/BounceItWeb.html) - Production; URL is "<http://www.uark.edu/ua/modphys/markup/BounceItWeb.html>"
[BoxIt](http://www.uark.edu/ua/modphys/markup/BoxItWeb.html) - Production; URL is "<http://www.uark.edu/ua/modphys/markup/BoxItWeb.html>"
[Coult](http://www.uark.edu/ua/modphys/markup/CoultWeb.html) - Production; URL is "<http://www.uark.edu/ua/modphys/markup/CoultWeb.html>"
[Cycloidulum](http://www.uark.edu/ua/modphys/markup/CycloidulumWeb.html) - Production; URL is "<http://www.uark.edu/ua/modphys/markup/CycloidulumWeb.html>"
[JerkIt](http://www.uark.edu/ua/modphys/markup/JerkItWeb.html) - Production; URL is "<http://www.uark.edu/ua/modphys/markup/JerkItWeb.html>"
[MolVibes](http://www.uark.edu/ua/modphys/markup/MolVibesWeb.html) - Production; URL is "<http://www.uark.edu/ua/modphys/markup/MolVibesWeb.html>"
[Pendulum](http://www.uark.edu/ua/modphys/markup/PendulumWeb.html) - Production; URL is "<http://www.uark.edu/ua/modphys/markup/PendulumWeb.html>"
[QuantIt](http://www.uark.edu/ua/modphys/markup/QuantItWeb.html) - Production; URL is "<http://www.uark.edu/ua/modphys/markup/QuantItWeb.html>"

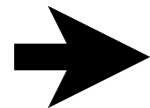

The old relativity website (2005):

[Relativity - Pirelli Entrant](http://www.uark.edu/ua/pirelli) - Production; URL is "<http://www.uark.edu/ua/pirelli>" or "<http://www.uark.edu/ua/pirelli/html/default.html>"

Newer relativity web-apps currently being developed (2013-)

[RelativIt](http://www.uark.edu/ua/modphys/markup/RelativItWeb.html) Production; URL is "<http://www.uark.edu/ua/modphys/markup/RelativItWeb.html>"
[RelaWavity](http://www.uark.edu/ua/modphys/markup/RelaWavityWeb.html) Production; URL is "<http://www.uark.edu/ua/modphys/markup/RelaWavityWeb.html>"

Additional classical wep-apps:

[Trebuchet](http://www.uark.edu/ua/modphys/markup/TrebuchetWeb.html) Production; URL is "<http://www.uark.edu/ua/modphys/markup/TrebuchetWeb.html>"
[WaveIt](http://www.uark.edu/ua/modphys/markup/WaveItWeb.html) Production; URL is "<http://www.uark.edu/ua/modphys/markup/WaveItWeb.html>"

Link to master list of all Harter-Soft Web Apps & Textbooks (Prod, Testing, & Developement)

<http://www.uark.edu/ua/modphys/testing/markup/Harter-SoftWebApps.html>