

Lecture 24

Thu. 11.17.2016

Parametric Resonance and Multi-particle Wave Modes

(Ch. 7-8 of Unit 4 11.24.15)

Two Kinds of Resonance: Linear-additive vs. Nonlinear-multiplicative (Parametric resonance)

Coupled rotation and translation (Throwing revisited: trebuchet, atlatl, etc.)

Schrodinger wave equation related to Parametric resonance dynamics

Electronic band theory and analogous mechanics

Wave resonance in cyclic symmetry

Harmonic oscillator with cyclic C_2 symmetry

C_2 symmetric (B-type) modes

Harmonic oscillator with cyclic C_3 symmetry

C_3 symmetric spectral decomposition by 3rd roots of unity

Resolving C_3 projectors and moving wave modes

Dispersion functions and standing waves

C_6 symmetric mode model: Distant neighbor coupling

C_6 spectra of gauge splitting by C-type symmetry (complex, chiral, coriolis, current, ...)

C_N symmetric mode models: Made-to order dispersion functions

Quadratic dispersion models: Super-beats and fractional revivals

Phase arithmetic

Algebra and geometry of resonant revivals: Farey Sums and Ford Circles

Relating C_N symmetric H and K matrices to differential wave operators

Two Kinds of Resonance

Linear or *additive resonance*.

Example: oscillating electric \mathbf{E} -field applied to a cyclotron orbit .

$$\ddot{x} + \omega_0^2 x = E_s \cos(\omega_s t)$$

*Chapter 4.2 study of FDHO
(Here damping $\Gamma \cong 0$)*

Two Kinds of Resonance

Linear or *additive resonance*.

Example: oscillating electric **E**-field applied to a cyclotron orbit .

$$\ddot{x} + \omega_0^2 x = E_s \cos(\omega_s t)$$

*Chapter 4.2 study of FDHO
(Here damping $\Gamma \cong 0$)*

Nonlinear or *multiplicative resonance*.

Example: oscillating magnetic **B**-field is applied to a cyclotron orbit.

$$\ddot{x} + \left(\omega_0^2 + B \cos(\omega_s t) \right) x = 0$$

Chapter 4.7

Also called *parametric resonance*.

Frequency parameter or spring constant $k=m\omega^2$ is being stimulated.

Two Kinds of Resonance

Linear or *additive resonance*.

Example: oscillating electric **E**-field applied to a cyclotron orbit .

$$\ddot{x} + \omega_0^2 x = E_s \cos(\omega_s t)$$

*Chapter 4.2 study of FDHO
(Here damping $\Gamma \cong 0$)*

Nonlinear or *multiplicative resonance*.

Example: oscillating magnetic **B**-field is applied to a cyclotron orbit.

$$\ddot{x} + \left(\omega_0^2 + B \cos(\omega_s t) \right) x = 0$$

Chapter 4.7

Also called *parametric resonance*.

Frequency parameter or spring constant $k=m\omega^2$ is being stimulated.

...Or pendulum accelerated up and down (*model to be used here*)

Two Kinds of Resonance: Linear-additive vs. Nonlinear-multiplicative (Parametric resonance)
→ *Coupled rotation and translation (Throwing revisited: trebuchet, atlatl, etc.)*
Schrodinger wave equation related to Parametric resonance dynamics
Electronic band theory and analogous mechanics

Coupled Rotation and Translation (Throwing)

Early non-human (or in-human) machines: trebuchets, whips.. (3000 BCE-1542 CE)

*X-stimulated pendulum:
(Quasi-Linear Resonance)*

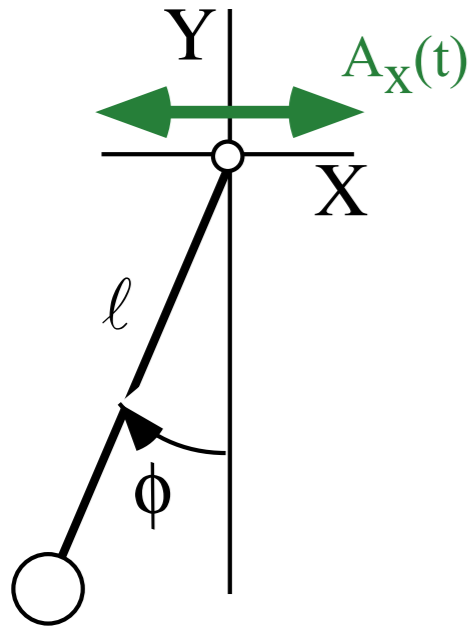

For small ϕ
($\cos \phi \sim 1$) :

*Y-stimulated pendulum:
(Non-Linear Resonance)*

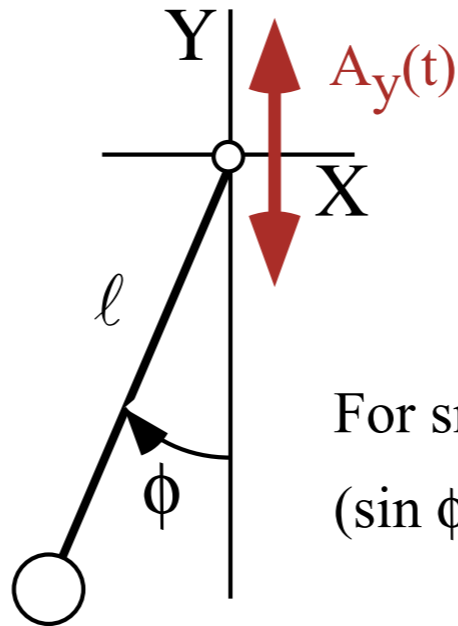

For small ϕ
($\sin \phi \sim \phi$) :

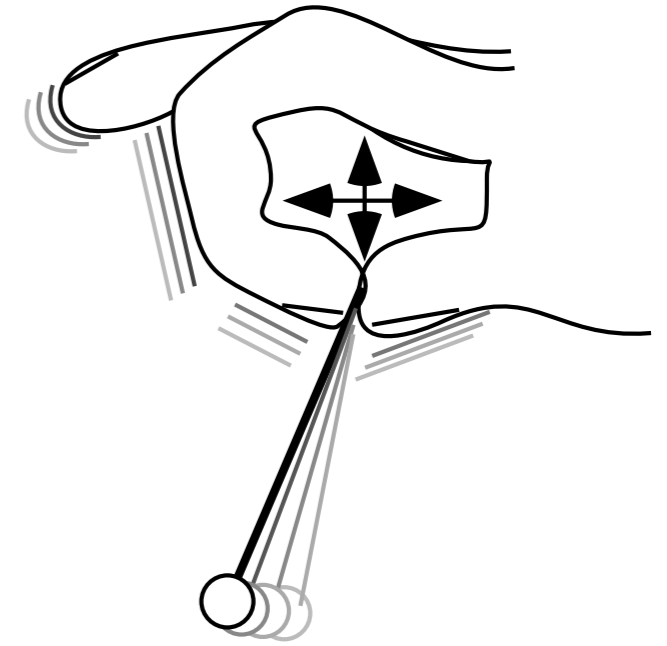

General ϕ :

Forced Harmonic Resonance

$$\frac{d^2\phi}{dt^2} + \frac{g}{l} \phi = \frac{A_x(t)}{l}$$

A Newtonian $F=Ma$ equation
Lorentz equation (with $\Gamma=0$)

Parametric Resonance

$$\frac{d^2\phi}{dt^2} + \left(\frac{g}{l} + \frac{A_y(t)}{l} \right) \phi = 0$$

A Schrodinger-like equation
(Time t replaces coord. x)

(1542-2012 CE)

General case: A Nasty equation!

$$\frac{d^2\phi}{dt^2} + \frac{g+A_y(t)}{l} \sin \phi + \frac{A_x(t)}{l} \cos \phi = 0$$

Coupled Rotation and Translation (Throwing)

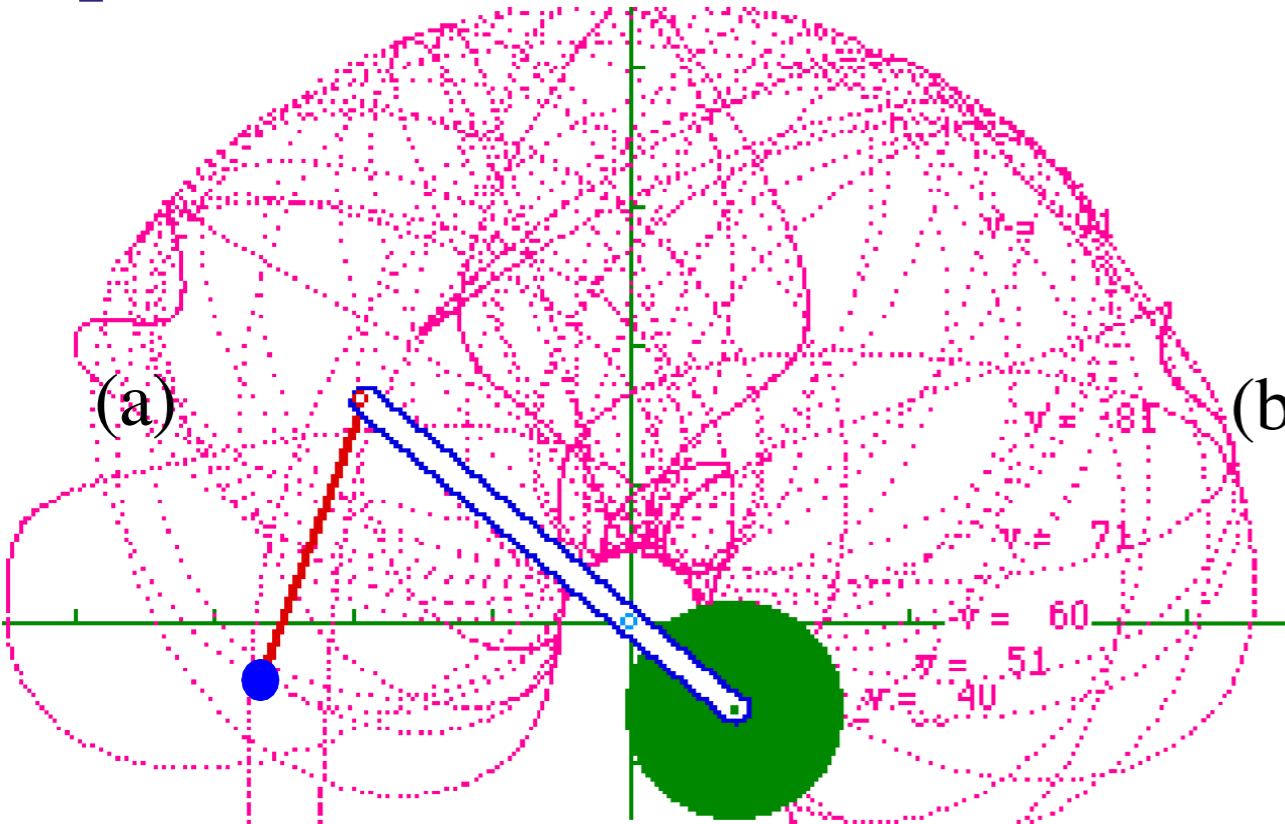

The "Arkansas Whirler"

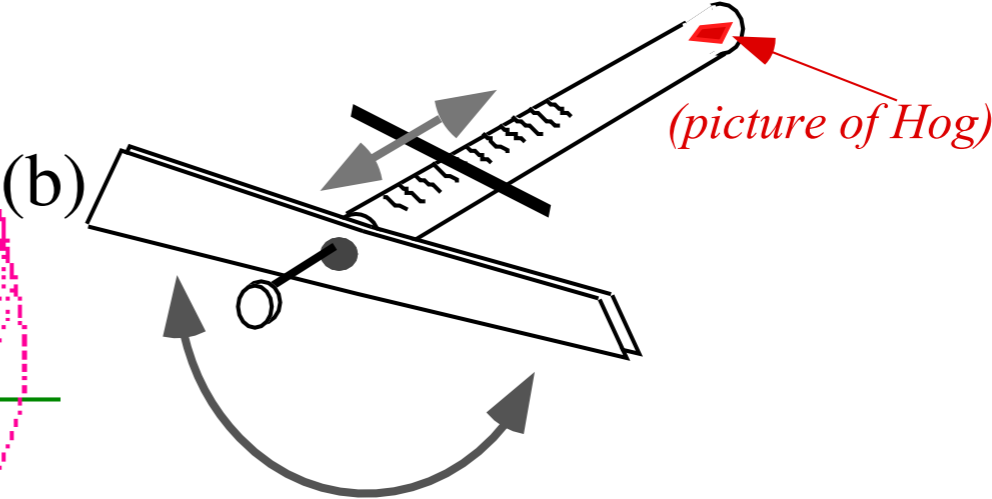

Chaotic motion from both linear and non-linear resonance (a) Trebuchet, (b) Whirler .

Positioned for linear resonance

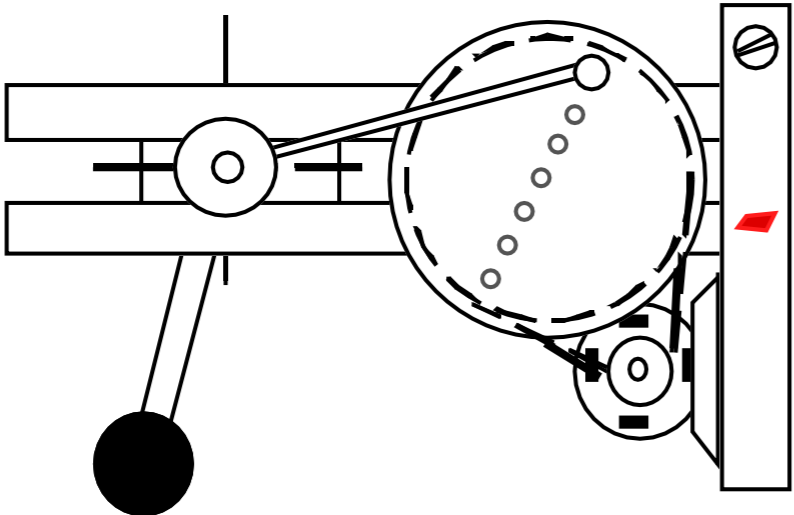

Positioned for nonlinear resonance

*device we hope to build
(...someday)*

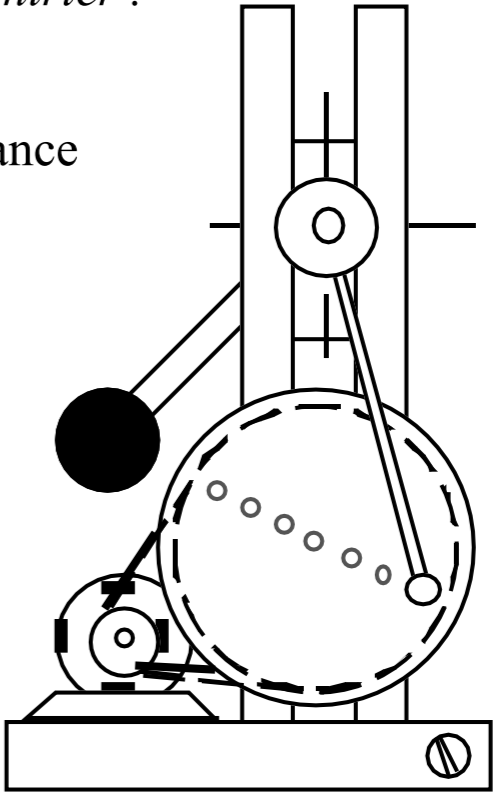

Two Kinds of Resonance: Linear-additive vs. Nonlinear-multiplicative (Parametric resonance)
Coupled rotation and translation (Throwing revisited: trebuchet, atlatl, etc.)
→ *Schrodinger wave equation related to Parametric resonance dynamics*
Electronic band theory and analogous mechanics

Schrodinger Equation Parametric Resonance



Jerked-Pendulum Trebuchet Dynamics

Schrodinger Wave Equation (With $m=1$ and $\hbar=1$)

$$\frac{d^2\phi}{dx^2} + (E - V(x))\phi = 0$$

With periodic potential

$$V(x) = -V_0 \cos(Nx)$$

main difference:
independent variable

← space= x

becomes

time= t →

Jerked Pendulum Equation

$$\frac{d^2\phi}{dt^2} + \left(\frac{g}{\ell} + \frac{A_y(t)}{\ell} \right) \phi = 0$$

On periodic roller coaster: $y = -A_y \cos \omega_y t$

$$A_y(t) = \omega_y^2 A_y \cos(\omega_y t)$$

Schrodinger Equation Parametric Resonance



Jerked-Pendulum Trebuchet Dynamics

Schrodinger Wave Equation (With $m=1$ and $\hbar=1$)

$$\frac{d^2\phi}{dx^2} + (E - V(x))\phi = 0$$

With periodic potential

$$V(x) = -V_0 \cos(Nx)$$

Mathieu Equation

$$\frac{d^2\phi}{dx^2} + (E + V_0 \cos(Nx))\phi = 0$$

main difference:
independent variable

← space= x

becomes

time= t →

Jerked Pendulum Equation

$$\frac{d^2\phi}{dt^2} + \left(\frac{g}{\ell} + \frac{A_y(t)}{\ell} \right) \phi = 0$$

On periodic roller coaster: $y = -A_y \cos \omega_y t$

$$A_y(t) = \omega_y^2 A_y \cos(\omega_y t)$$

$$\frac{d^2\phi}{dt^2} + \left(\frac{g}{\ell} + \frac{\omega_y^2 A_y}{\ell} \cos(\omega_y t) \right) \phi = 0$$

Schrodinger Equation Parametric Resonance



Jerked-Pendulum Trebuchet Dynamics

Schrodinger Wave Equation (With $m=1$ and $\hbar=1$)

$$\frac{d^2\phi}{dx^2} + (E - V(x))\phi = 0$$

With periodic potential

$$V(x) = -V_0 \cos(Nx)$$

Mathieu Equation

$$\frac{d^2\phi}{dx^2} + (E + V_0 \cos(Nx))\phi = 0$$

main difference:
independent variable

← space= x

becomes

time= t →

$$Nx = \omega_y t$$

Connection
Relations

Jerked Pendulum Equation

$$\frac{d^2\phi}{dt^2} + \left(\frac{g}{\ell} + \frac{A_y(t)}{\ell} \right) \phi = 0$$

On periodic roller coaster: $y = -A_y \cos \omega_y t$

$$A_y(t) = \omega_y^2 A_y \cos(\omega_y t)$$

$$\frac{d^2\phi}{dt^2} + \left(\frac{g}{\ell} + \frac{\omega_y^2 A_y}{\ell} \cos(\omega_y t) \right) \phi = 0$$

Schrodinger Equation Parametric Resonance



Jerked-Pendulum Trebuchet Dynamics

Schrodinger Wave Equation (With $m=1$ and $\hbar=1$)

$$\frac{d^2\phi}{dx^2} + (E - V(x))\phi = 0$$

With periodic potential

$$V(x) = -V_0 \cos(Nx)$$

Mathieu Equation

$$\frac{d^2\phi}{dx^2} + (E + V_0 \cos(Nx))\phi = 0$$

$$\frac{N}{\omega_y} dx = dt$$

main difference:
independent variable

← space=x

becomes

time=t →

Jerked Pendulum Equation

$$\frac{d^2\phi}{dt^2} + \left(\frac{g}{l} + \frac{A_y(t)}{l} \right) \phi = 0$$

On periodic roller coaster: $y = -A_y \cos \omega_y t$

$$A_y(t) = \omega_y^2 A_y \cos(\omega_y t)$$

$$\frac{d^2\phi}{dt^2} + \left(\frac{g}{l} + \frac{\omega_y^2 A_y}{l} \cos(\omega_y t) \right) \phi = 0$$

$$Nx = \omega_y t$$

Connection
Relations

$$\frac{N^2}{\omega_y^2} dx^2 = dt^2$$

Schrodinger Equation Parametric Resonance



Jerked-Pendulum Trebuchet Dynamics

Schrodinger Wave Equation (With $m=1$ and $\hbar=1$)

$$\frac{d^2\phi}{dx^2} + (E - V(x))\phi = 0$$

main difference:
independent variable

← space= x

becomes

time= t →

With periodic potential

$$V(x) = -V_0 \cos(Nx)$$

Mathieu Equation

$$\frac{d^2\phi}{dx^2} + (E + V_0 \cos(Nx))\phi = 0$$

$$\frac{N}{\omega_y} dx = dt$$

$$Nx = \omega_y t$$

Connection
Relations

$$\frac{N^2}{\omega_y^2} dx^2 = dt^2$$

Let $N=2$ to get
Band-edge modes

Jerked Pendulum Equation

$$\frac{d^2\phi}{dt^2} + \left(\frac{g}{l} + \frac{A_y(t)}{l} \right) \phi = 0$$

On periodic roller coaster: $y = -A_y \cos \omega_y t$

$$A_y(t) = \omega_y^2 A_y \cos(\omega_y t)$$

$$\frac{d^2\phi}{dt^2} + \left(\frac{g}{l} + \frac{\omega_y^2 A_y}{l} \cos(\omega_y t) \right) \phi = 0$$

$$\frac{d^2\phi}{dx^2} + \frac{N^2}{\omega_y^2} \left(\frac{g}{l} + \frac{\omega_y^2 A_y}{l} \cos(Nx) \right) \phi = 0$$

Schrodinger Equation Parametric Resonance



Jerked-Pendulum Trebuchet Dynamics

Schrodinger Wave Equation (With $m=1$ and $\hbar=1$)

$$\frac{d^2\phi}{dx^2} + (E - V(x))\phi = 0$$

With periodic potential

$$V(x) = -V_0 \cos(Nx)$$

Mathieu Equation

$$\frac{d^2\phi}{dx^2} + (E + V_0 \cos(Nx))\phi = 0$$

$$E = \frac{N^2}{\omega_y^2} \frac{g}{\ell}$$

main difference:
independent variable

← space= x

becomes

time= t →

Jerked Pendulum Equation

$$\frac{d^2\phi}{dt^2} + \left(\frac{g}{\ell} + \frac{A_y(t)}{\ell} \right) \phi = 0$$

On periodic roller coaster: $y = -A_y \cos \omega_y t$

$$A_y(t) = \omega_y^2 A_y \cos(\omega_y t)$$

$$\frac{d^2\phi}{dt^2} + \left(\frac{g}{\ell} + \frac{\omega_y^2 A_y}{\ell} \cos(\omega_y t) \right) \phi = 0$$

$$\frac{d^2\phi}{dx^2} + \frac{N^2}{\omega_y^2} \left(\frac{g}{\ell} + \frac{\omega_y^2 A_y}{\ell} \cos(Nx) \right) \phi = 0$$

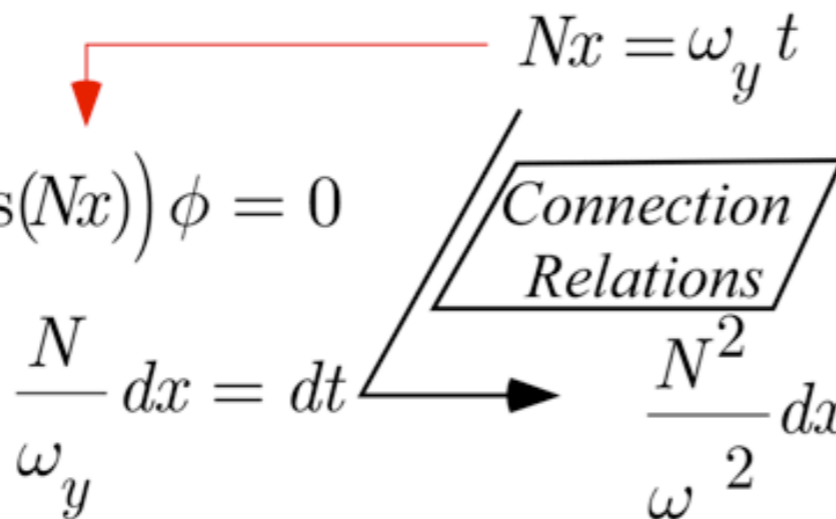

Let $N=2$ to get
Band-edge modes

QM Energy E -to- ω_y Jerk frequency Connection

Schrodinger Equation Parametric Resonance



Jerked-Pendulum Trebuchet Dynamics

Schrodinger Wave Equation (With $m=1$ and $\hbar=1$)

$$\frac{d^2\phi}{dx^2} + (E - V(x))\phi = 0$$

main difference:
independent variable

← space=x

becomes

time=t →

With periodic potential

$$V(x) = -V_0 \cos(Nx)$$

Jerked Pendulum Equation

$$\frac{d^2\phi}{dt^2} + \left(\frac{g}{\ell} + \frac{A_y(t)}{\ell} \right) \phi = 0$$

On periodic roller coaster: $y = -A_y \cos \omega_y t$

$$A_y(t) = \omega_y^2 A_y \cos(\omega_y t)$$

Mathieu Equation

$$\frac{d^2\phi}{dx^2} + (E + V_0 \cos(Nx))\phi = 0$$

$$Nx = \omega_y t$$

$$\frac{N}{\omega_y} dx = dt$$

$$\frac{N^2}{\omega_y^2} dx^2 = dt^2$$

$$\frac{d^2\phi}{dt^2} + \left(\frac{g}{\ell} + \frac{\omega_y^2 A_y}{\ell} \cos(\omega_y t) \right) \phi = 0$$

$$\frac{d^2\phi}{dx^2} + \frac{N^2}{\omega_y^2} \left(\frac{g}{\ell} + \frac{\omega_y^2 A_y}{\ell} \cos(Nx) \right) \phi = 0$$

Let $N=2$ to get
Band-edge modes

$$E = \frac{N^2}{\omega_y^2} \frac{g}{\ell}$$

QM Energy E -to- ω_y Jerk frequency Connection

$$V_0 = \frac{N^2 A_y}{\ell}$$

QM Potential V_0 - A_y Amplitude Connection

Schrodinger Equation Parametric Resonance



Jerked-Pendulum Trebuchet Dynamics

Schrodinger Wave Equation (With $m=1$ and $\hbar=1$)

$$\frac{d^2\phi}{dx^2} + (E - V(x))\phi = 0$$

With periodic potential

$$V(x) = -V_0 \cos(Nx)$$

Mathieu Equation

$$\frac{d^2\phi}{dx^2} + (E + V_0 \cos(Nx))\phi = 0$$

$$\frac{N}{\omega_y} dx = dt$$

Let $N=2$ to get
Band-edge modes

$$E = \frac{4}{\omega_y^2} g$$

For $N=2$
and $\ell=1$

$$V_0 = 4A_y$$

main difference:
independent variable

← space= x

becomes

time= t →

Jerked Pendulum Equation

$$\frac{d^2\phi}{dt^2} + \left(\frac{g}{\ell} + \frac{A_y(t)}{\ell} \right) \phi = 0$$

On periodic roller coaster: $y = -A_y \cos \omega_y t$

$$A_y(t) = \omega_y^2 A_y \cos(\omega_y t)$$

$$\frac{d^2\phi}{dt^2} + \left(\frac{g}{\ell} + \frac{\omega_y^2 A_y}{\ell} \cos(\omega_y t) \right) \phi = 0$$

$$\frac{d^2\phi}{dx^2} + \frac{N^2}{\omega_y^2} \left(\frac{g}{\ell} + \frac{\omega_y^2 A_y}{\ell} \cos(Nx) \right) \phi = 0$$

QM Energy E -to- ω_y Jerk frequency Connection

QM Potential V_0 - A_y Amplitude Connection

Two Kinds of Resonance: Linear-additive vs. Nonlinear-multiplicative (Parametric resonance)
Coupled rotation and translation (Throwing revisited: trebuchet, atlatl, etc.)
Schrodinger wave equation related to Parametric resonance dynamics
➔ *Electronic band theory and analogous mechanics*

Electronic band theory and analogous mechanics

Suppose Schrodinger potential V is zero and, by analogy, the pendulum Y-stimulus A_y is zero

$$-\frac{d^2\phi}{dx^2} = E\phi$$

independent variable
← *space=x*
becomes
time=t →

$$-\frac{d^2\phi}{dt^2} = \omega_0^2\phi$$

Electronic band theory and analogous mechanics

Suppose Schrodinger potential V is zero and, by analogy, the pendulum Y-stimulus A_y is zero

$$-\frac{d^2\phi}{dx^2} = E\phi$$

independent variable
← *space=x*
becomes
time=t →

$$-\frac{d^2\phi}{dt^2} = \omega_0^2\phi$$

Eigen-solutions are the familiar *Bohr orbitals* or, for the pendulum, the familiar phasor waves

$$\langle x|k\rangle = \phi_k(x) = \frac{e^{\pm ikx}}{\sqrt{2\pi}}, \text{ where: } E=k^2$$

$$\langle t|\omega\rangle = \phi_\omega(t) = \frac{e^{\pm i\omega_0 t}}{\sqrt{2\pi}}, \text{ where: } \omega_0 = \sqrt{\frac{g}{\ell}}$$

Electronic band theory and analogous mechanics

Suppose Schrodinger potential V is zero and, by analogy, the pendulum Y-stimulus A_y is zero

$$-\frac{d^2\phi}{dx^2} = E\phi$$

independent variable
← *space=x*
 becomes
time=t →

$$-\frac{d^2\phi}{dt^2} = \omega_0^2\phi$$

Eigen-solutions are the familiar *Bohr orbitals* or, for the pendulum, the familiar phasor waves

$$\langle x|k\rangle = \phi_k(x) = \frac{e^{\pm ikx}}{\sqrt{2\pi}}, \text{ where: } E=k^2$$

$$\langle t|\omega\rangle = \phi_\omega(t) = \frac{e^{\pm i\omega_0 t}}{\sqrt{2\pi}}, \text{ where: } \omega_0 = \sqrt{\frac{g}{\ell}}$$

Bohr has *periodic boundary conditions* x between 0 and L

Pendulum repeats perfectly after a time T .

$$\phi(0) = \phi(L) \Rightarrow e^{ikL} = 1, \text{ or: } k = \frac{2\pi m}{L}$$

$$\phi(0) = \phi(T) \Rightarrow e^{i\omega_0 T} = 1, \text{ or: } \omega_0 = \frac{2\pi m}{T}$$

Electronic band theory and analogous mechanics

Suppose Schrodinger potential V is zero and, by analogy, the pendulum Y-stimulus A_y is zero

$$-\frac{d^2\phi}{dx^2} = E\phi \quad \begin{array}{c} \text{independent variable} \\ \leftarrow \text{space} = x \\ \text{becomes} \\ \text{time} = t \rightarrow \end{array} \quad -\frac{d^2\phi}{dt^2} = \omega_0^2\phi$$

Eigen-solutions are the familiar *Bohr orbitals* or, for the pendulum, the familiar phasor waves

$$\langle x | k \rangle = \phi_k(x) = \frac{e^{\pm ikx}}{\sqrt{2\pi}}, \text{ where: } E = k^2 \quad \langle t | \omega \rangle = \phi_\omega(t) = \frac{e^{\pm i\omega_0 t}}{\sqrt{2\pi}}, \text{ where: } \omega_0 = \sqrt{\frac{g}{\ell}}$$

Bohr has *periodic boundary conditions* x between 0 and L Pendulum repeats perfectly after a time T .

$$\phi(0) = \phi(L) \Rightarrow e^{ikL} = 1, \text{ or: } k = \frac{2\pi m}{L} \quad \phi(0) = \phi(T) \Rightarrow e^{i\omega_0 T} = 1, \text{ or: } \omega_0 = \frac{2\pi m}{T}$$

Limit $L=2\pi=T$ for both analogies. Then the allowed energies and frequencies follow

$$E = k^2 = 0, 1, 4, 9, 16, \dots \quad \omega_0 = m = 0, \pm 1, \pm 2, \pm 3, \pm 4, \dots$$

Electronic band theory and analogous mechanics

Suppose Schrodinger potential V is zero and, by analogy, the pendulum Y-stimulus A_y is zero

$$-\frac{d^2\phi}{dx^2} = E\phi \quad \begin{array}{c} \text{independent variable} \\ \leftarrow \text{space}=x \\ \text{becomes} \\ \text{time}=t \rightarrow \end{array} \quad -\frac{d^2\phi}{dt^2} = \omega_0^2\phi$$

Eigen-solutions are the familiar *Bohr orbitals* or, for the pendulum, the familiar phasor waves

$$\langle x|k\rangle = \phi_k(x) = \frac{e^{\pm ikx}}{\sqrt{2\pi}}, \text{ where: } E=k^2 \quad \langle t|\omega\rangle = \phi_\omega(t) = \frac{e^{\pm i\omega_0 t}}{\sqrt{2\pi}}, \text{ where: } \omega_0 = \sqrt{\frac{g}{\ell}}$$

Bohr has *periodic boundary conditions* x between 0 and L Pendulum repeats perfectly after a time T .

$$\phi(0) = \phi(L) \Rightarrow e^{ikL} = 1, \text{ or: } k = \frac{2\pi m}{L} \quad \phi(0) = \phi(T) \Rightarrow e^{i\omega_0 T} = 1, \text{ or: } \omega_0 = \frac{2\pi m}{T}$$

Limit $L=2\pi=T$ for both analogies. Then the allowed energies and frequencies follow

$$E = k^2 = 0, 1, 4, 9, 16, \dots \quad \omega_0 = m = 0, \pm 1, \pm 2, \pm 3, \pm 4, \dots$$

Schrodinger equation with non-zero V solved in Fourier basis

$$-\frac{d^2\phi}{dx^2} + V_0 \cos(Nx)\phi = E\phi, \quad (\mathbf{D} + \mathbf{V})|\phi\rangle = E|\phi\rangle$$

Fourier representation: $\langle j|\mathbf{D}|k\rangle = j^2\delta_j^k$

$$\Sigma \langle j|(\mathbf{D} + \mathbf{V})|k\rangle \langle k|\phi\rangle = E \langle j|\phi\rangle$$

Matrix eigenvalue equation

Electronic band theory and analogous mechanics

Suppose Schrodinger potential V is zero and, by analogy, the pendulum Y-stimulus A_y is zero

$$-\frac{d^2\phi}{dx^2} = E\phi \quad \begin{array}{c} \text{independent variable} \\ \leftarrow \text{space}=x \\ \text{becomes} \\ \text{time}=t \rightarrow \end{array} \quad -\frac{d^2\phi}{dt^2} = \omega_0^2\phi$$

Eigen-solutions are the familiar *Bohr orbitals* or, for the pendulum, the familiar phasor waves

$$\langle x|k\rangle = \phi_k(x) = \frac{e^{\pm ikx}}{\sqrt{2\pi}}, \text{ where: } E=k^2 \quad \langle t|\omega\rangle = \phi_\omega(t) = \frac{e^{\pm i\omega_0 t}}{\sqrt{2\pi}}, \text{ where: } \omega_0 = \sqrt{\frac{g}{\ell}}$$

Bohr has *periodic boundary conditions* x between 0 and L Pendulum repeats perfectly after a time T .

$$\phi(0) = \phi(L) \Rightarrow e^{ikL} = 1, \text{ or: } k = \frac{2\pi m}{L} \quad \phi(0) = \phi(T) \Rightarrow e^{i\omega_0 T} = 1, \text{ or: } \omega_0 = \frac{2\pi m}{T}$$

Limit $L=2\pi=T$ for both analogies. Then the allowed energies and frequencies follow

$$E = k^2 = 0, 1, 4, 9, 16, \dots \quad \omega_0 = m = 0, \pm 1, \pm 2, \pm 3, \pm 4, \dots$$

Schrodinger equation with non-zero V solved in Fourier basis

$$-\frac{d^2\phi}{dx^2} + V_0 \cos(Nx)\phi = E\phi, \quad (\mathbf{D} + \mathbf{V})|\phi\rangle = E|\phi\rangle$$

Fourier representation: $\langle j|\mathbf{D}|k\rangle = j^2\delta_j^k$ and $\langle j|\mathbf{V}|k\rangle = \int_0^{2\pi} dx \frac{e^{-ijx}}{\sqrt{2\pi}} V_0 \cos(Nx) \frac{e^{+ikx}}{\sqrt{2\pi}} = \int_0^{2\pi} dx \frac{e^{-i(j-k)x}}{2\pi} V_0 \frac{e^{-iNx} + e^{iNx}}{2}$

$$\Sigma \langle j|(\mathbf{D} + \mathbf{V})|k\rangle \langle k|\phi\rangle = E \langle j|\phi\rangle \quad = \frac{V_0}{2} (\delta_j^{k+N} + \delta_j^{k-N})$$

Matrix eigenvalue equation

Electronic band theory and analogous mechanics

Suppose Schrodinger potential V is zero and, by analogy, the pendulum Y-stimulus A_y is zero

$$-\frac{d^2\phi}{dx^2} = E\phi$$

$$-\frac{d^2\phi}{dt^2} = \omega_0^2\phi$$

Eigen-solutions are the familiar *Bohr orbitals* or, for the pendulum, the familiar phasor waves

$$\langle x|k\rangle = \phi_k(x) = \frac{e^{\pm ikx}}{\sqrt{2\pi}}, \text{ where: } E=k^2$$

$$\langle t|\omega\rangle = \phi_\omega(t) = \frac{e^{\pm i\omega_0 t}}{\sqrt{2\pi}}, \text{ where: } \omega_0 = \sqrt{\frac{g}{\ell}}$$

Bohr has *periodic boundary conditions* x between 0 and L Pendulum repeats perfectly after a time T .

$$\phi(0) = \phi(L) \Rightarrow e^{ikL} = 1, \text{ or: } k = \frac{2\pi m}{L}$$

$$\phi(0) = \phi(T) \Rightarrow e^{i\omega_0 T} = 1, \text{ or: } \omega_0 = \frac{2\pi m}{T}$$

Limit $L=2\pi=T$ for both analogies. Then the allowed energies and frequencies follow

$$E = k^2 = 0, 1, 4, 9, 16, \dots$$

$$\omega_0 = m = 0, \pm 1, \pm 2, \pm 3, \pm 4, \dots$$

Schrodinger equation with non-zero V solved in Fourier basis

$$-\frac{d^2\phi}{dx^2} + V_0 \cos(Nx)\phi = E\phi, \quad (\mathbf{D} + \mathbf{V})|\phi\rangle = E|\phi\rangle$$

Fourier representation: $\langle j|\mathbf{D}|k\rangle = j^2\delta_j^k$ and $\langle j|\mathbf{V}|k\rangle = \int_0^{2\pi} dx \frac{e^{-ijx}}{\sqrt{2\pi}} V_0 \cos(Nx) \frac{e^{+ikx}}{\sqrt{2\pi}} = \int_0^{2\pi} dx \frac{e^{-i(j-k)x}}{2\pi} V_0 \frac{e^{-iNx} + e^{iNx}}{2}$

$$\Sigma \langle j|(\mathbf{D} + \mathbf{V})|k\rangle \langle k|\phi\rangle = E \langle j|\phi\rangle = \frac{V_0}{2} (\delta_j^{k+N} + \delta_j^{k-N})$$

Matrix eigenvalue equation

(Move Fourier reps. to top)

Electronic band theory and analogous mechanics

Schrodinger equation with non-zero V solved in Fourier basis

$$-\frac{d^2\phi}{dx^2} + V_0 \cos(Nx)\phi = E\phi, \quad (\mathbf{D} + \mathbf{V})|\phi\rangle = E|\phi\rangle$$

Fourier representation: $\langle j|\mathbf{D}|k\rangle = j^2\delta_j^k$ and $\langle j|\mathbf{V}|k\rangle = \int_0^{2\pi} dx \frac{e^{-ijx}}{\sqrt{2\pi}} V_0 \cos(Nx) \frac{e^{+ikx}}{\sqrt{2\pi}} = \int_0^{2\pi} dx \frac{e^{-i(j-k)x}}{2\pi} V_0 \frac{e^{-iNx} + e^{iNx}}{2}$

$$\sum \langle j|(\mathbf{D} + \mathbf{V})|k\rangle \langle k|\phi\rangle = E \langle j|\phi\rangle$$

Matrix eigenvalue equation

$$= \frac{V_0}{2} (\delta_j^{k+N} + \delta_j^{k-N})$$

Electronic band theory and analogous mechanics

Schrodinger equation with non-zero V solved in Fourier basis

$$-\frac{d^2\phi}{dx^2} + V_0 \cos(Nx)\phi = E\phi, \quad (\mathbf{D} + \mathbf{V})|\phi\rangle = E|\phi\rangle$$

Fourier representation: $\langle j|\mathbf{D}|k\rangle = j^2\delta_j^k$ and $\langle j|\mathbf{V}|k\rangle = \int_0^{2\pi} dx \frac{e^{-ijx}}{\sqrt{2\pi}} V_0 \cos(Nx) \frac{e^{+ikx}}{\sqrt{2\pi}} = \int_0^{2\pi} dx \frac{e^{-i(j-k)x}}{2\pi} V_0 \frac{e^{-iNx} + e^{iNx}}{2}$

$$\sum \langle j|(\mathbf{D} + \mathbf{V})|k\rangle \langle k|\phi\rangle = E \langle j|\phi\rangle$$

Matrix eigenvalue equation

$$= \frac{V_0}{2} (\delta_j^{k+N} + \delta_j^{k-N})$$

$\langle j|(\mathbf{D} + \mathbf{V})|k\rangle =$ (for j and k even)

... $| -6\rangle, | -4\rangle, | -2\rangle, | 0\rangle, | 2\rangle, | 4\rangle, | 6\rangle, \dots$

$\langle j|(\mathbf{D} + \mathbf{V})|k\rangle =$ (for j and k odd)

... $| -7\rangle, | -5\rangle, | -3\rangle, | -1\rangle, | 1\rangle, | 3\rangle, | 5\rangle, \dots$

$\begin{pmatrix} \vdots & & & & & & & & \\ \langle -6 & & 6^2 & v & & & & & \\ \langle -4 & & v & 4^2 & v & & & & \\ \langle -2 & & & v & 2^2 & v & & & \\ \langle -0 & & & & v & 0 & v & & \\ \langle +2 & & & & & v & 2^2 & v & \\ \langle +4 & & & & & & v & 4^2 & v \\ \langle +6 & & & & & & & v & 6^2 \\ \vdots & & & & & & & & \end{pmatrix},$	$\begin{pmatrix} \vdots & & & & & & & & \\ \langle -7 & & 7^2 & v & & & & & \\ \langle -5 & & v & 5^2 & v & & & & \\ \langle -3 & & & v & 3^2 & v & & & \\ \langle -1 & & & & v & 1^2 & v & & \\ \langle +1 & & & & & v & 1^2 & v & \\ \langle +3 & & & & & & v & 3^2 & v \\ \langle +5 & & & & & & & v & 5^2 \\ \vdots & & & & & & & & \end{pmatrix}$
<p>Connection relations from p. 15-16</p>	<p>Here: $v = \frac{V_0}{2} = \frac{4A_y}{2\ell} = \frac{2A_y}{\ell} = 2A_y$ For N=2 and l=1</p>

E_m -values vary with amplitude V_0 or wobble amplitude $A_y = V_0 \ell / N^2 = 2v / N^2 = v/2$.

($N=2$ and $\ell=1$ here)

Eigenvalues for $V_0=0.2$ or $v=0.1$ and $V_0=2.0$ or $v=1.0$.

$E_0 =$	-0.0050
$E_{1^-} =$	0.8988
$E_{1^+} =$	1.0987
$E_{2^-} =$	3.9992
$E_{2^+} =$	4.0042
$E_{3^-} =$	9.0006
$E_{3^+} =$	9.0006

← inverted

$E_0 =$	-0.4551
$E_{1^-} =$	-0.1102
$E_{1^+} =$	1.8591
$E_{2^-} =$	3.9170
$E_{2^+} =$	4.3713
$E_{3^-} =$	9.0477
$E_{3^+} =$	9.0784

← inverted

← inverted

Connection relations from p. 15-16

When pendulum is "normal" and near its lowest point ($\phi \sim 0$) then $\cos \phi \sim 1$ and $\sin \phi \sim \phi$

$$\frac{d^2\phi}{dx^2} + \frac{N^2}{\omega_y^2} \left(\frac{g}{\ell} - \frac{\omega_y^2 A_y}{\ell} \cos(Nx) \right) \phi = 0 = \frac{d^2\phi}{dx^2} + \left(\frac{N^2 g}{\omega_y^2 \ell} - \frac{N^2 A_y}{\ell} \cos(Nx) \right) \phi, \text{ (where: } \phi \sim 0 \text{)}$$

When pendulum is "inverted" near highest point ($\phi \sim \pi$) then $\cos \phi \sim -1$ and $\sin \phi \sim \pi - \phi$.

$$\frac{d^2\phi}{dt^2} - \left(\frac{g}{\ell} - \frac{\omega_y^2 A_y}{\ell} \cos(\omega_y t) \right) (\phi - \pi) = 0, \text{ (where: } \phi \sim \pi \text{)}$$

E_m -eigenvalue determines pendulum Y-wobble frequency $\omega_{y(m)}$.

$$E_m = \frac{N^2 g}{\omega_{y(m)}^2 \ell} \quad \text{implies:} \quad \omega_{y(m)} = \frac{N}{\sqrt{E_m}} \sqrt{\frac{g}{\ell}} = \frac{2}{\sqrt{E_m}} \quad (g=1, \text{ too})$$

Pendulum Y-wobble frequency $\omega_{y(m)}$ for $V_0=0.2$ and for $V_0=2.0$.

$\omega_{y(0)} = 2 / \sqrt{.0050}$	= 28.2843
$\omega_{y(1^-)} = 2 / \sqrt{.8988}$	= 2.10959
$\omega_{y(1^+)} = 2 / \sqrt{1.0987}$	= 1.90805
$\omega_{y(2^-)} = 2 / \sqrt{3.9992}$	= 1.00010
$\omega_{y(2^+)} = 2 / \sqrt{4.0042}$	= 0.99948

← inverted

$\omega_{y(0)} = 2 / \sqrt{.4551}$	= 2.9646
$\omega_{y(1^-)} = 2 / \sqrt{.1102}$	= 6.02475
$\omega_{y(1^+)} = 2 / \sqrt{1.8591}$	= 1.4668
$\omega_{y(2^-)} = 2 / \sqrt{3.9170}$	= 1.0105
$\omega_{y(2^+)} = 2 / \sqrt{4.3713}$	= 0.9566

← inverted

← inverted

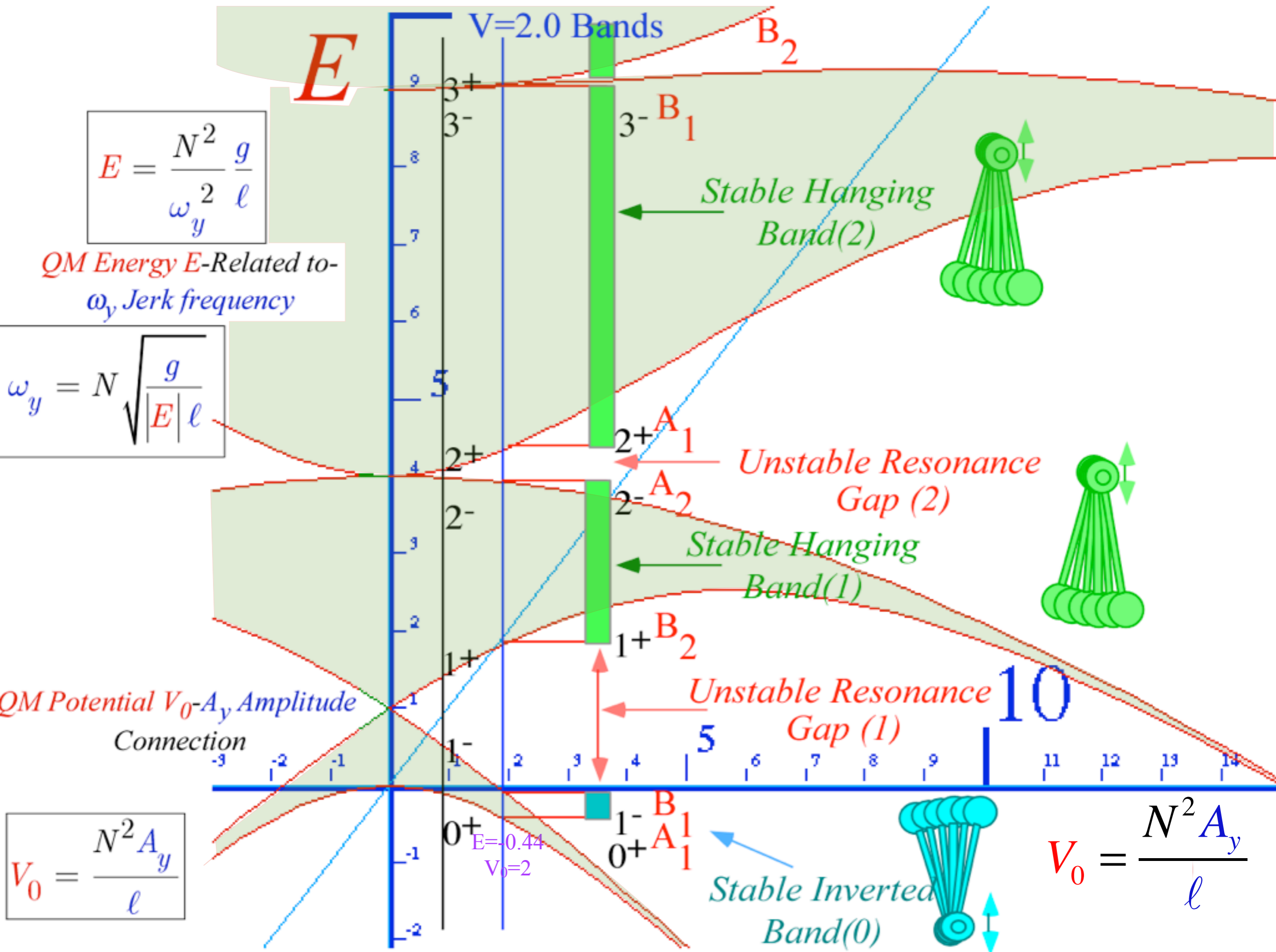

E

$V=2.0$ Bands

$$E = \frac{4}{\omega_y^2} g$$

QM Energy E -Related to ω_y Jerk frequency

$$\omega_y = 2\sqrt{\frac{g}{E}}$$

For $N=2$ and $\ell=1$

QM Potential V_0 - A_y Amplitude Connection

$$V_0 = 4A_y$$

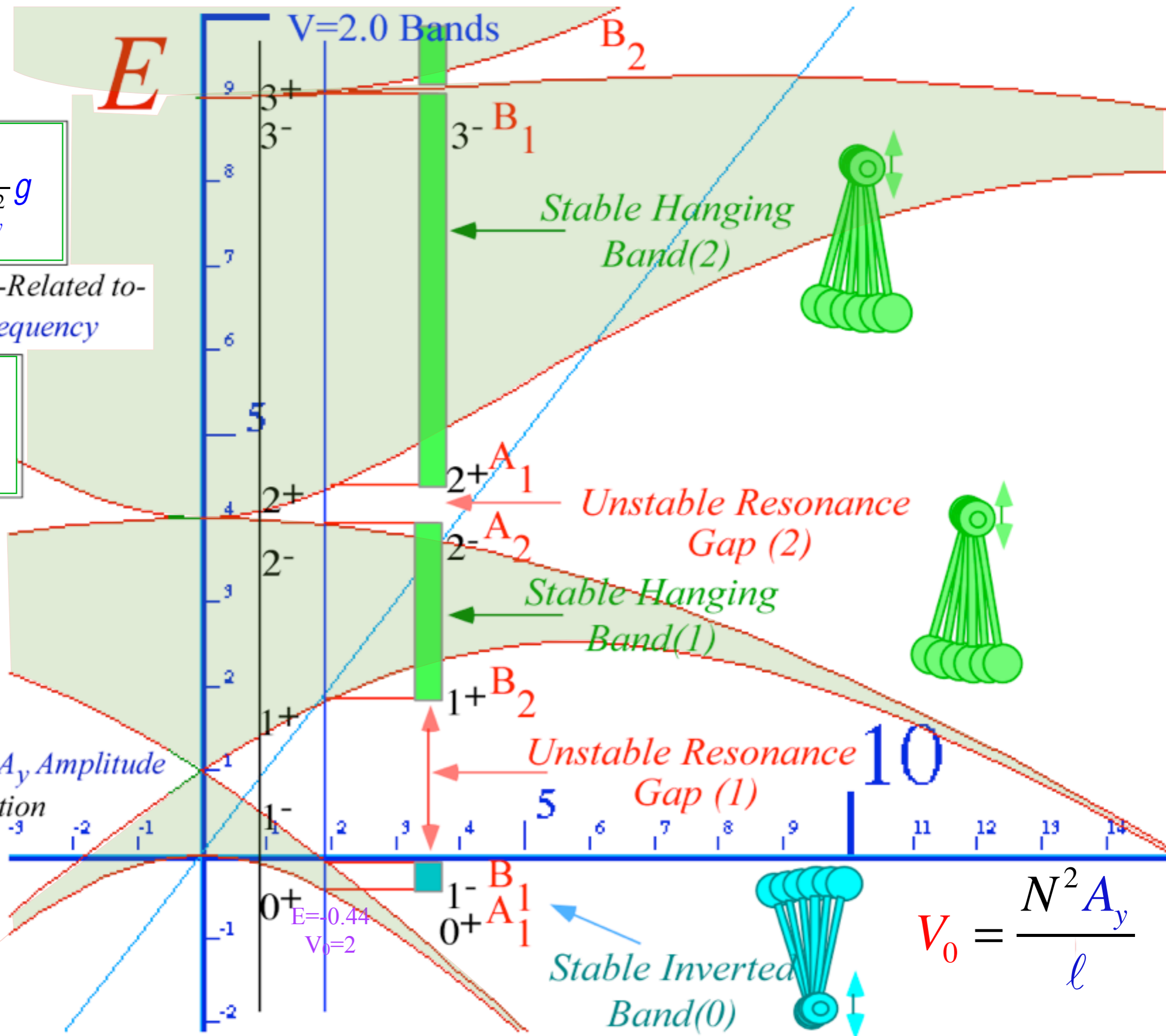

$E=-0.44$
 $V_0=2$

10

$$V_0 = \frac{N^2 A_y}{\ell}$$

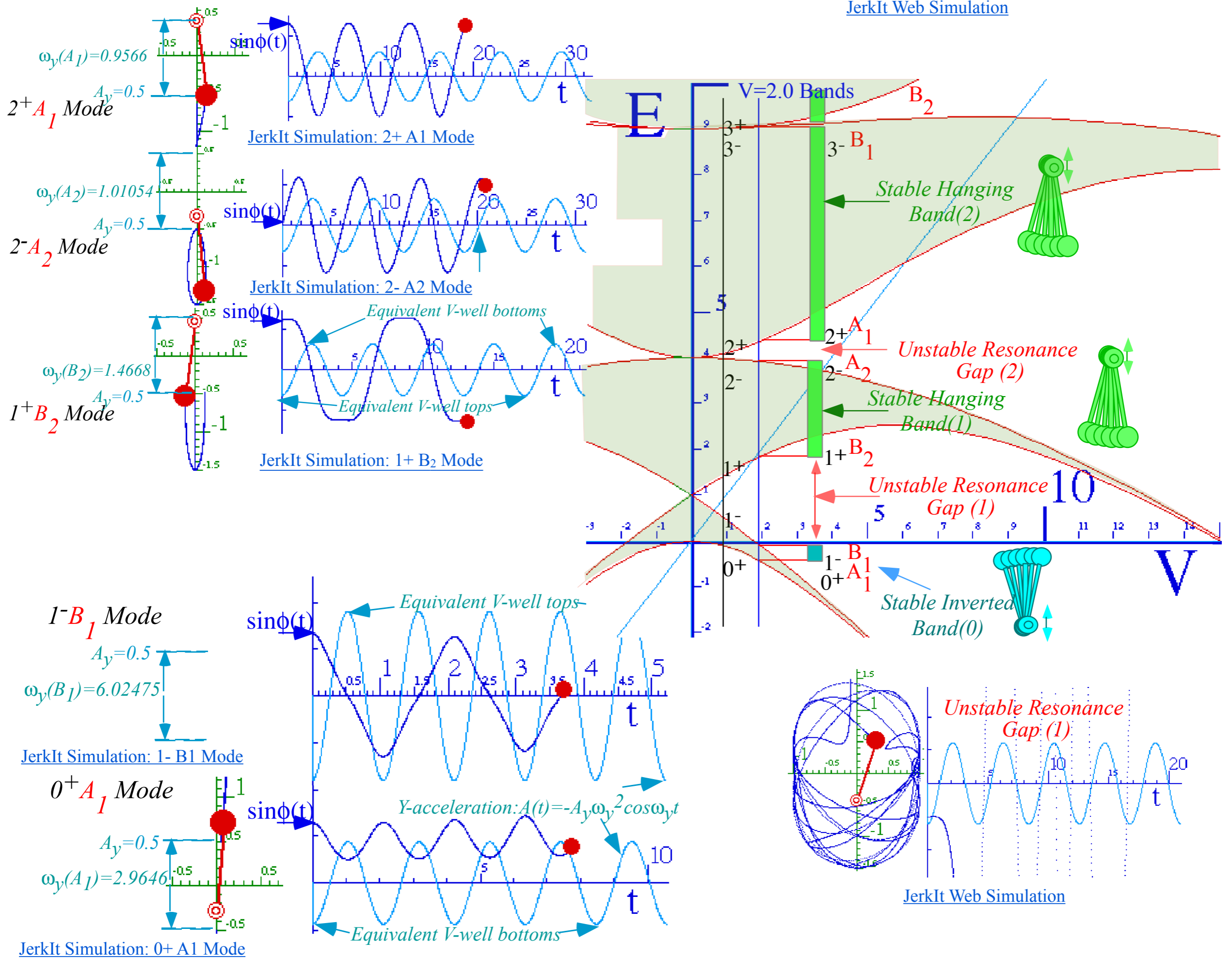

JerkIt Web Simulation

A quick look at band splitting for a square periodic potential (Kronig-Penney Model)

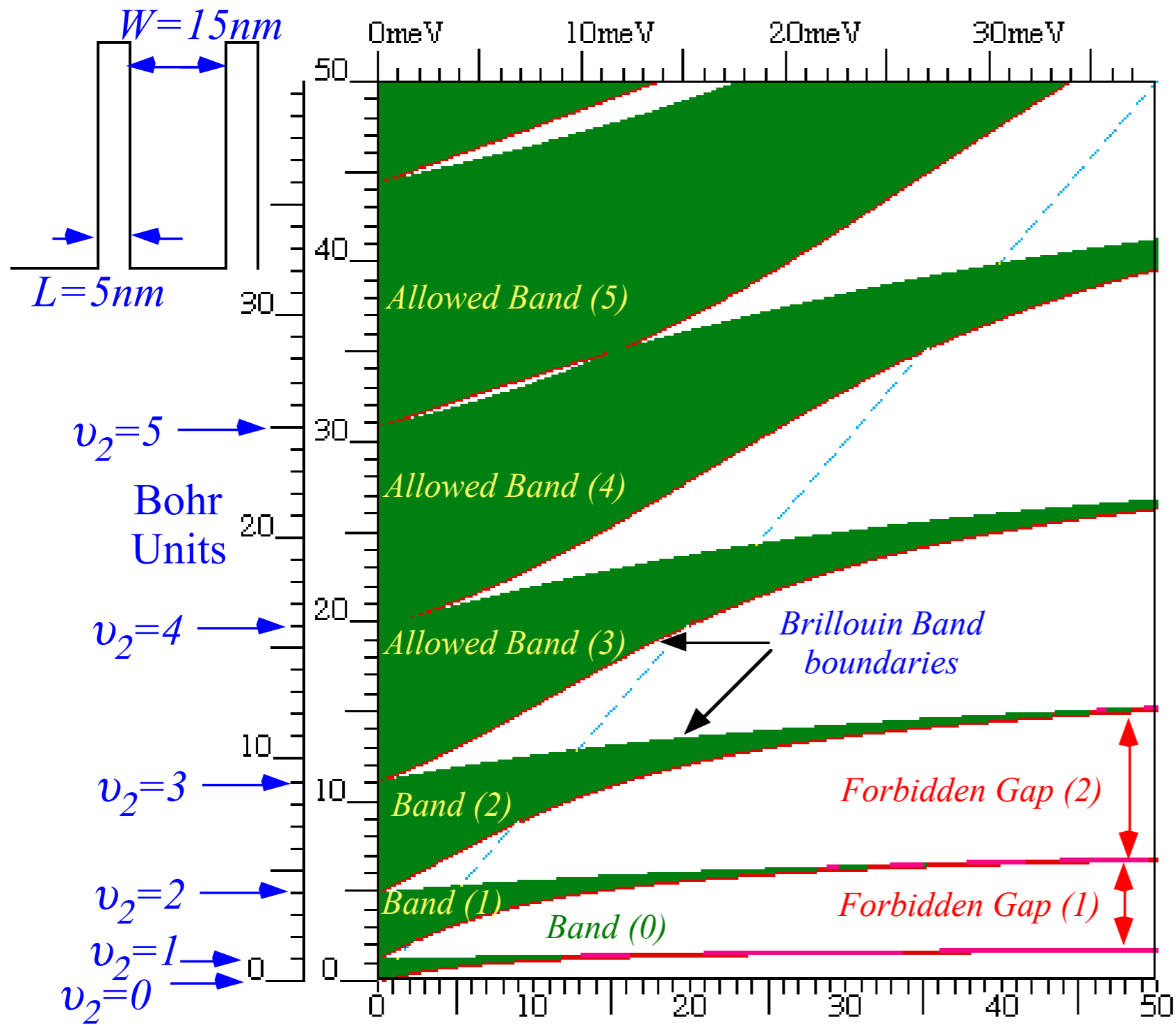

*(From Ch. 14 Unit 5
Quantum Theory for the
Computer Age (QT_{ft}CA))*

Fig. 14.2.7 Bands vs. V . ($W=15\text{nm}$ well, $L=5\text{nm}$ barrier) showing Bohr splitting for $(N=2)$ -ring.

A quick look at band splitting for a square periodic potential (Kronig-Penney Model)

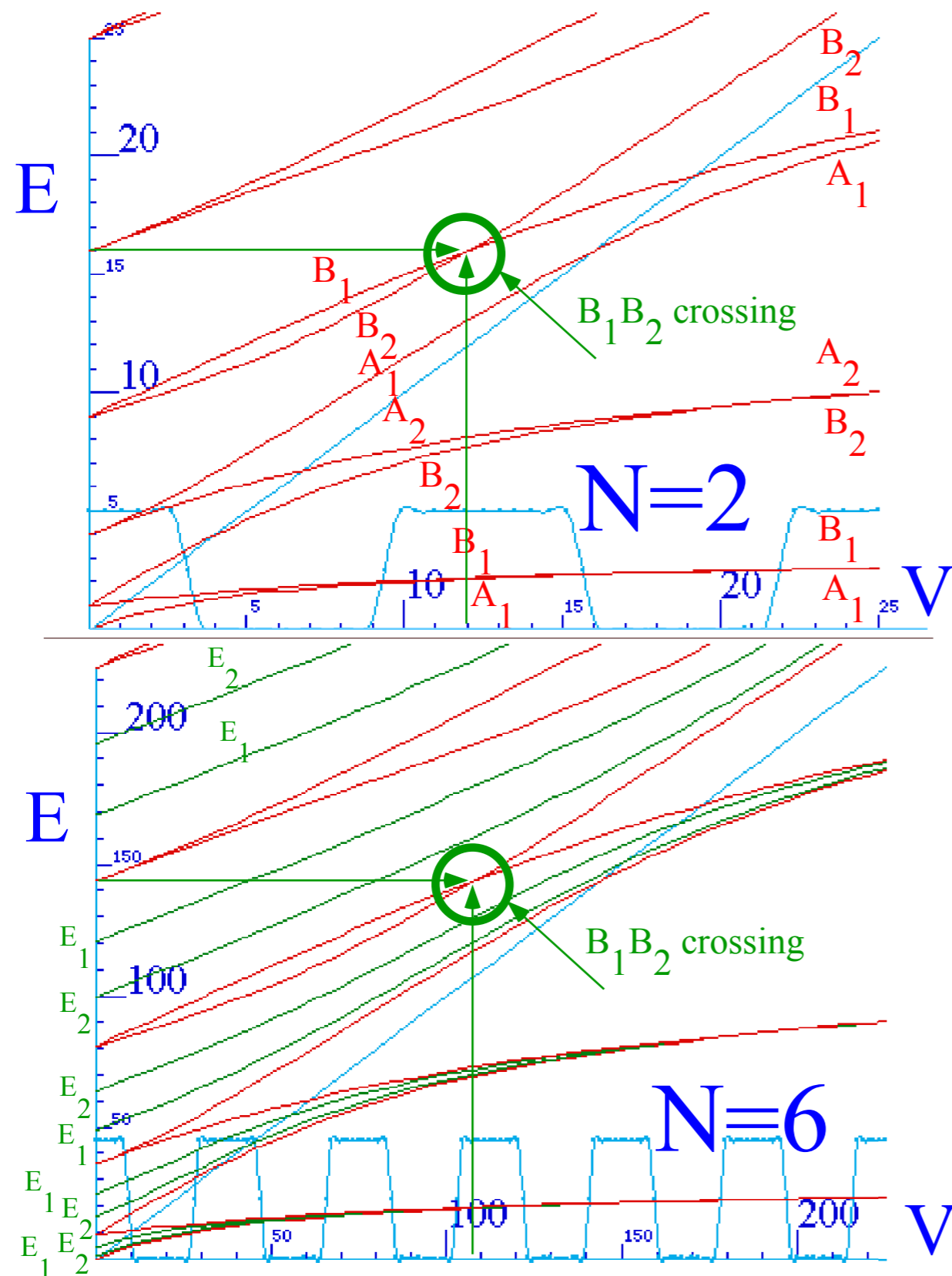

*(From Ch. 14 Unit 5
Quantum Theory for the
Computer Age (QT_{ft}CA)*

Fig. 14.2.13 (B_1, B_2) crossing for: $(N=2)$ at $V=12$ and $E=16$, and $(N=6)$ at $V=144$ and $E=108$.

Wave resonance in cyclic symmetry

➔ *Harmonic oscillator with cyclic C_2 symmetry*

C_2 symmetric (B-type) modes

Harmonic oscillator with cyclic C_3 symmetry

C_3 symmetric spectral decomposition by 3rd roots of unity

Resolving C_3 projectors and moving wave modes

Dispersion functions and standing waves

C_6 symmetric mode model: Distant neighbor coupling

C_6 spectra of gauge splitting by C-type symmetry (complex, chiral, coriolis, current, .

C_N symmetric mode models: Made-to order dispersion functions

Quadratic dispersion models: Super-beats and fractional revivals

Phase arithmetic

Wave resonance in cyclic symmetry

Harmonic oscillator with cyclic C_2 symmetry (B-type)

Hamiltonian matrix \mathbf{H} or spring-constant matrix $\mathbf{K}=\mathbf{H}^2$ with B-type or *bilateral-balanced* symmetry

$$\mathbf{H} = \begin{pmatrix} A & B \\ B & A \end{pmatrix} = A \begin{pmatrix} 1 & 0 \\ 0 & 1 \end{pmatrix} + B \begin{pmatrix} 0 & 1 \\ 1 & 0 \end{pmatrix}$$
$$= A \cdot \mathbf{1} + B \cdot \sigma_B$$

$$\mathbf{K} = \mathbf{H}^2 = \begin{pmatrix} A^2 + B^2 & 2AB \\ 2AB & A^2 + B^2 \end{pmatrix}$$
$$= (A^2 + B^2) \cdot \mathbf{1} + 2AB \cdot \sigma_B$$

C_2	$\mathbf{1}$	σ_B
$\mathbf{1}$	$\mathbf{1}$	σ_B
σ_B	σ_B	$\mathbf{1}$

Reflection symmetry σ_B defined by $(\sigma_B)^2 = \mathbf{1}$ in C_2 group product table.

Wave resonance in cyclic symmetry

Harmonic oscillator with cyclic C_2 symmetry (B-type)

Hamiltonian matrix \mathbf{H} or spring-constant matrix $\mathbf{K}=\mathbf{H}^2$ with B-type or *bilateral-balanced* symmetry

$$\mathbf{H} = \begin{pmatrix} A & B \\ B & A \end{pmatrix} = A \begin{pmatrix} 1 & 0 \\ 0 & 1 \end{pmatrix} + B \begin{pmatrix} 0 & 1 \\ 1 & 0 \end{pmatrix}$$

$$= A \cdot \mathbf{1} + B \cdot \sigma_B$$

$$\mathbf{K} = \mathbf{H}^2 = \begin{pmatrix} A^2 + B^2 & 2AB \\ 2AB & A^2 + B^2 \end{pmatrix}$$

$$= (A^2 + B^2) \cdot \mathbf{1} + 2AB \cdot \sigma_B$$

C_2	$\mathbf{1}$	σ_B
$\mathbf{1}$	$\mathbf{1}$	σ_B
σ_B	σ_B	$\mathbf{1}$

Reflection symmetry σ_B defined by $(\sigma_B)^2 = \mathbf{1}$ in C_2 group product table.

(a) unit base state $|\mathbf{1}\rangle = \mathbf{1}|\mathbf{1}\rangle$

(b) unit base state $|\sigma_B\rangle = \sigma_B|\mathbf{1}\rangle$

$$|0\rangle = |x\rangle = |2\rangle = \begin{pmatrix} 1 \\ 0 \end{pmatrix}$$

$$|1\rangle = |y\rangle = |-1\rangle = \begin{pmatrix} 0 \\ 1 \end{pmatrix}$$

(c) equilibrium zero-state $\begin{pmatrix} 0 \\ 0 \end{pmatrix}$

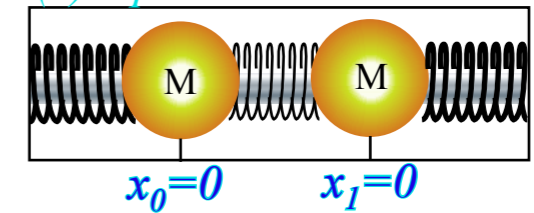
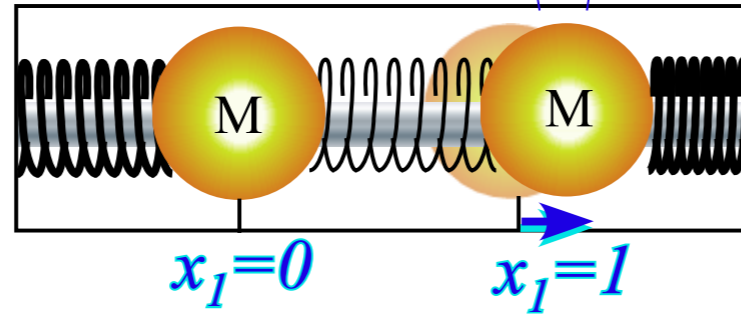
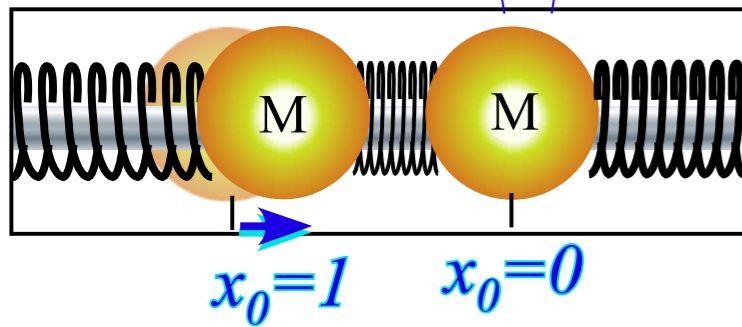

Wave resonance in cyclic symmetry

Harmonic oscillator with cyclic C_2 symmetry (B-type)

Hamiltonian matrix \mathbf{H} or spring-constant matrix $\mathbf{K}=\mathbf{H}^2$ with B-type or *bilateral-balanced* symmetry

$$\mathbf{H} = \begin{pmatrix} A & B \\ B & A \end{pmatrix} = A \begin{pmatrix} 1 & 0 \\ 0 & 1 \end{pmatrix} + B \begin{pmatrix} 0 & 1 \\ 1 & 0 \end{pmatrix}$$

$$= A \cdot \mathbf{1} + B \cdot \sigma_B$$

$$\mathbf{K} = \mathbf{H}^2 = \begin{pmatrix} A^2 + B^2 & 2AB \\ 2AB & A^2 + B^2 \end{pmatrix}$$

$$= (A^2 + B^2) \cdot \mathbf{1} + 2AB \cdot \sigma_B$$

C_2	$\mathbf{1}$	σ_B
$\mathbf{1}$	$\mathbf{1}$	σ_B
σ_B	σ_B	$\mathbf{1}$

Reflection symmetry σ_B defined by $(\sigma_B)^2 = \mathbf{1}$ in C_2 group product table.

(a) unit base state $|\mathbf{1}\rangle = \mathbf{1}|\mathbf{1}\rangle$
 $|0\rangle = |x\rangle = |2\rangle = \begin{pmatrix} 1 \\ 0 \end{pmatrix}$

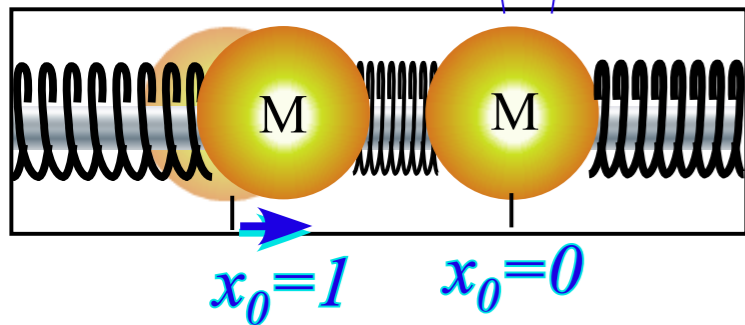

(b) unit base state $|\sigma_B\rangle = \sigma_B|\mathbf{1}\rangle$
 $|1\rangle = |y\rangle = |-1\rangle = \begin{pmatrix} 0 \\ 1 \end{pmatrix}$

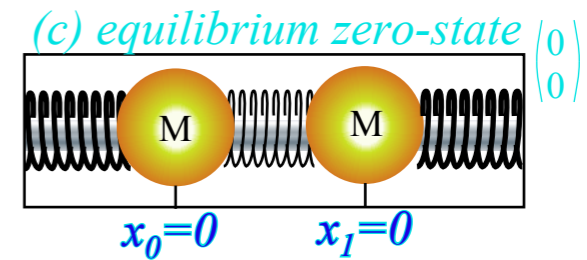
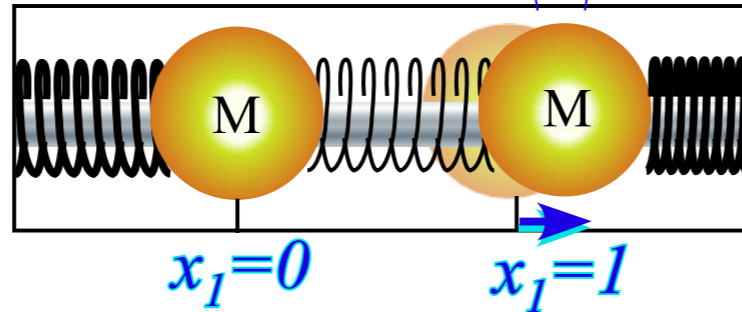

$(\sigma_B)^2 = \mathbf{1}$ or: $(\sigma_B)^2 - \mathbf{1} = \mathbf{0}$ gives projectors:
 $(\sigma_B + \mathbf{1}) \cdot (\sigma_B - \mathbf{1}) = \mathbf{0} = \mathbf{p}^{(+1)} \cdot \mathbf{p}^{(-1)}$

Wave resonance in cyclic symmetry

Harmonic oscillator with cyclic C_2 symmetry (B-type)

Hamiltonian matrix \mathbf{H} or spring-constant matrix $\mathbf{K}=\mathbf{H}^2$ with B-type or *bilateral-balanced* symmetry

$$\mathbf{H} = \begin{pmatrix} A & B \\ B & A \end{pmatrix} = A \begin{pmatrix} 1 & 0 \\ 0 & 1 \end{pmatrix} + B \begin{pmatrix} 0 & 1 \\ 1 & 0 \end{pmatrix}$$

$$= A \cdot \mathbf{1} + B \cdot \sigma_B$$

$$\mathbf{K} = \mathbf{H}^2 = \begin{pmatrix} A^2 + B^2 & 2AB \\ 2AB & A^2 + B^2 \end{pmatrix}$$

$$= (A^2 + B^2) \cdot \mathbf{1} + 2AB \cdot \sigma_B$$

C_2	$\mathbf{1}$	σ_B
$\mathbf{1}$	$\mathbf{1}$	σ_B
σ_B	σ_B	$\mathbf{1}$

Reflection symmetry σ_B defined by $(\sigma_B)^2 = \mathbf{1}$ in C_2 group product table.

(a) unit base state $|\mathbf{1}\rangle = \mathbf{1}|\mathbf{1}\rangle$
 $|0\rangle = |x\rangle = |2\rangle = \begin{pmatrix} 1 \\ 0 \end{pmatrix}$

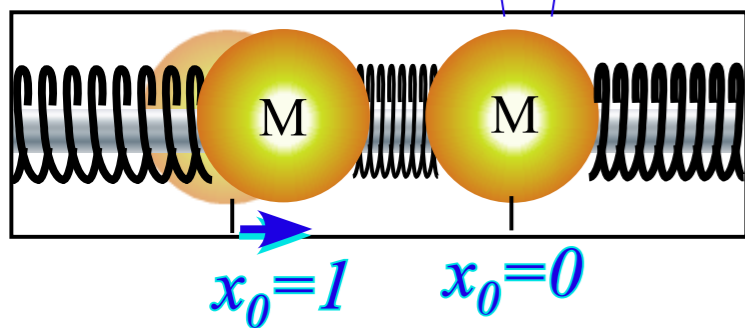

(b) unit base state $|\sigma_B\rangle = \sigma_B|\mathbf{1}\rangle$
 $|1\rangle = |y\rangle = |-1\rangle = \begin{pmatrix} 0 \\ 1 \end{pmatrix}$

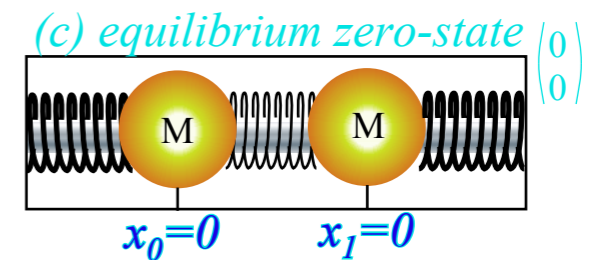
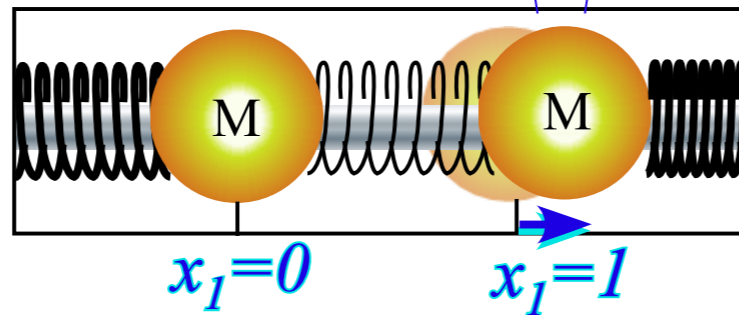

$(\sigma_B)^2 = \mathbf{1}$ or: $(\sigma_B)^2 - \mathbf{1} = \mathbf{0}$ gives projectors:

$$(\sigma_B + \mathbf{1}) \cdot (\sigma_B - \mathbf{1}) = \mathbf{0} = \mathbf{p}^{(+1)} \cdot \mathbf{p}^{(-1)}$$

$$\mathbf{P}^{(+)} = (\mathbf{1} + \sigma_B) / 2 \text{ and } \mathbf{P}^{(-)} = (\mathbf{1} - \sigma_B) / 2$$

(Normed so: $\mathbf{P}^{(+)} + \mathbf{P}^{(-)} = \mathbf{1}$ and: $\mathbf{P}^{(m)} \cdot \mathbf{P}^{(m)} = \mathbf{P}^{(m)}$)

Wave resonance in cyclic symmetry

Harmonic oscillator with cyclic C_2 symmetry (B-type)

Hamiltonian matrix \mathbf{H} or spring-constant matrix $\mathbf{K}=\mathbf{H}^2$ with B-type or *bilateral-balanced* symmetry

$$\mathbf{H} = \begin{pmatrix} A & B \\ B & A \end{pmatrix} = A \begin{pmatrix} 1 & 0 \\ 0 & 1 \end{pmatrix} + B \begin{pmatrix} 0 & 1 \\ 1 & 0 \end{pmatrix}$$

$$= A \cdot \mathbf{1} + B \cdot \sigma_B$$

$$\mathbf{K} = \mathbf{H}^2 = \begin{pmatrix} A^2 + B^2 & 2AB \\ 2AB & A^2 + B^2 \end{pmatrix}$$

$$= (A^2 + B^2) \cdot \mathbf{1} + 2AB \cdot \sigma_B$$

C_2	$\mathbf{1}$	σ_B
$\mathbf{1}$	$\mathbf{1}$	σ_B
σ_B	σ_B	$\mathbf{1}$

Reflection symmetry σ_B defined by $(\sigma_B)^2 = \mathbf{1}$ in C_2 group product table.

(a) unit base state $|\mathbf{1}\rangle = \mathbf{1}|\mathbf{1}\rangle$
 $|0\rangle = |x\rangle = |2\rangle = \begin{pmatrix} 1 \\ 0 \end{pmatrix}$

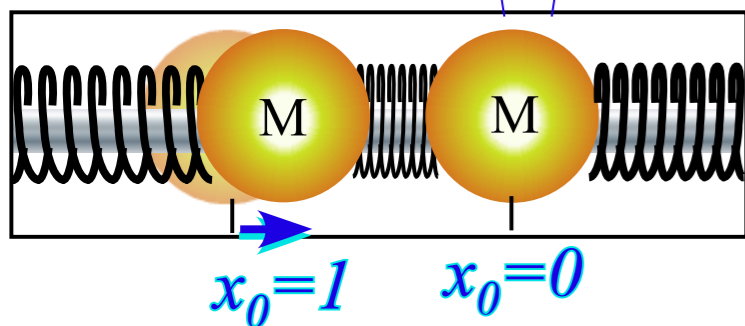

(b) unit base state $|\sigma_B\rangle = \sigma_B|\mathbf{1}\rangle$
 $|1\rangle = |y\rangle = |-1\rangle = \begin{pmatrix} 0 \\ 1 \end{pmatrix}$

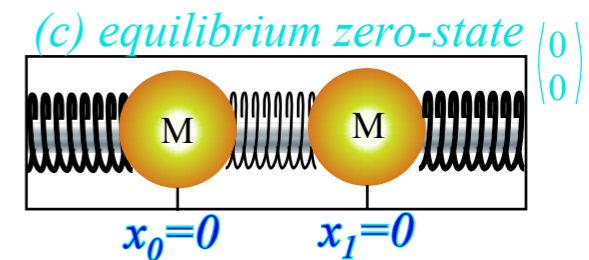
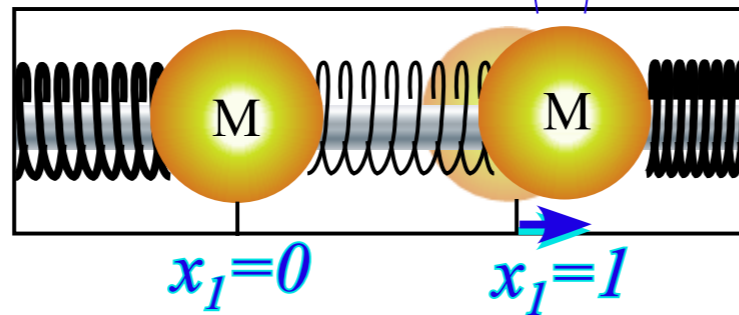

C_2 symmetry (B-type) modes

(a) Even mode $|+\rangle = |0_2\rangle = \frac{1}{\sqrt{2}} \begin{pmatrix} 1 \\ 1 \end{pmatrix}$

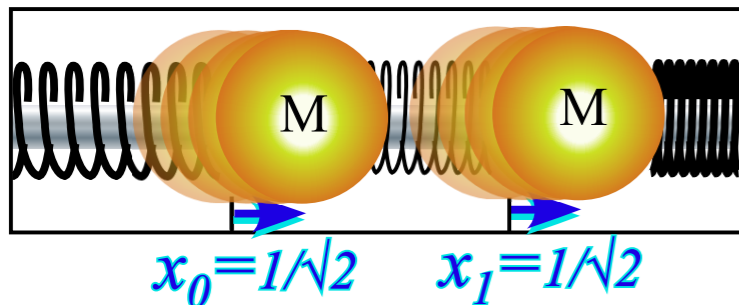

(b) Odd mode $|-\rangle = |1_2\rangle = \frac{1}{\sqrt{2}} \begin{pmatrix} 1 \\ -1 \end{pmatrix}$

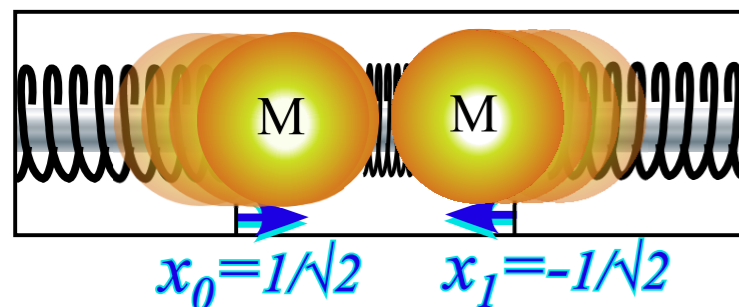

$(\sigma_B)^2 = \mathbf{1}$ or: $(\sigma_B)^2 - \mathbf{1} = \mathbf{0}$ gives projectors:

$$(\sigma_B + \mathbf{1}) \cdot (\sigma_B - \mathbf{1}) = \mathbf{0} = \mathbf{p}^{(+)} \cdot \mathbf{p}^{(-)}$$

$$\mathbf{P}^{(+)} = (\mathbf{1} + \sigma_B)/2 \text{ and } \mathbf{P}^{(-)} = (\mathbf{1} - \sigma_B)/2$$

(Normed so: $\mathbf{P}^{(+)} + \mathbf{P}^{(-)} = \mathbf{1}$ and: $\mathbf{P}^{(m)} \cdot \mathbf{P}^{(m)} = \mathbf{P}^{(m)}$)

Wave resonance in cyclic symmetry

Harmonic oscillator with cyclic C_2 symmetry (B-type)

Hamiltonian matrix \mathbf{H} or spring-constant matrix $\mathbf{K}=\mathbf{H}^2$ with B-type or *bilateral-balanced* symmetry

$$\mathbf{H} = \begin{pmatrix} A & B \\ B & A \end{pmatrix} = A \begin{pmatrix} 1 & 0 \\ 0 & 1 \end{pmatrix} + B \begin{pmatrix} 0 & 1 \\ 1 & 0 \end{pmatrix}$$

$$= A \cdot \mathbf{1} + B \cdot \sigma_B$$

$$\mathbf{K} = \mathbf{H}^2 = \begin{pmatrix} A^2 + B^2 & 2AB \\ 2AB & A^2 + B^2 \end{pmatrix}$$

$$= (A^2 + B^2) \cdot \mathbf{1} + 2AB \cdot \sigma_B$$

C_2	$\mathbf{1}$	σ_B
$\mathbf{1}$	$\mathbf{1}$	σ_B
σ_B	σ_B	$\mathbf{1}$

Reflection symmetry σ_B defined by $(\sigma_B)^2 = \mathbf{1}$ in C_2 group product table.

(a) unit base state $|\mathbf{1}\rangle = \mathbf{1}|\mathbf{1}\rangle$
 $|0\rangle = |x\rangle = |2\rangle = \begin{pmatrix} 1 \\ 0 \end{pmatrix}$

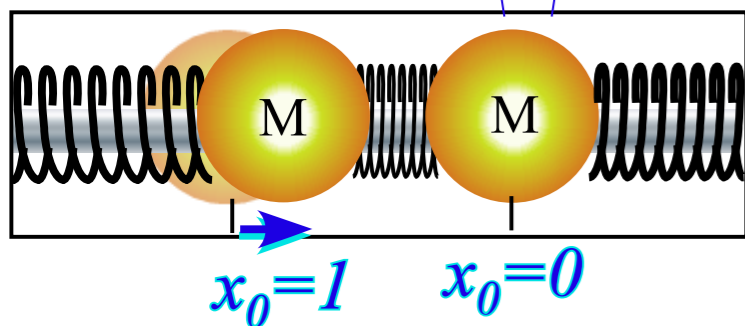

(b) unit base state $|\sigma_B\rangle = \sigma_B|\mathbf{1}\rangle$
 $|1\rangle = |y\rangle = |-1\rangle = \begin{pmatrix} 0 \\ 1 \end{pmatrix}$

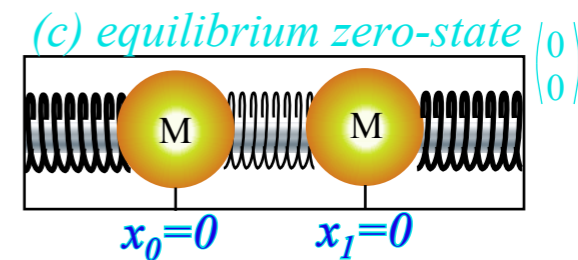
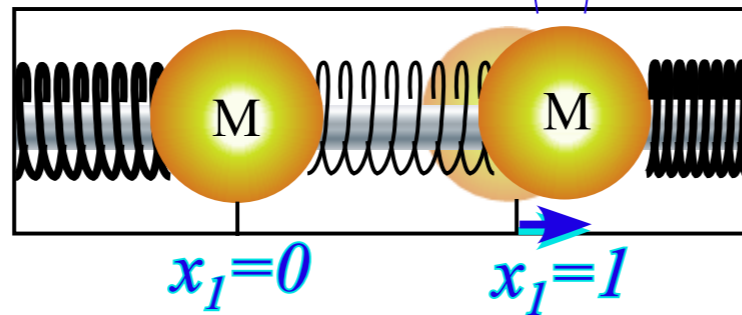

C_2 symmetry (B-type) modes

(a) Even mode $|+\rangle = |0_2\rangle = \frac{1}{\sqrt{2}} \begin{pmatrix} 1 \\ 1 \end{pmatrix}$

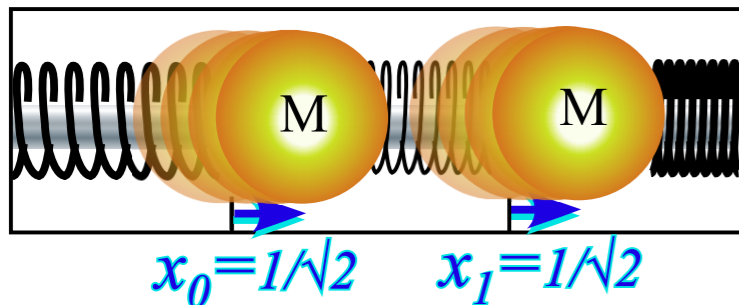

(b) Odd mode $|-\rangle = |1_2\rangle = \frac{1}{\sqrt{2}} \begin{pmatrix} 1 \\ -1 \end{pmatrix}$

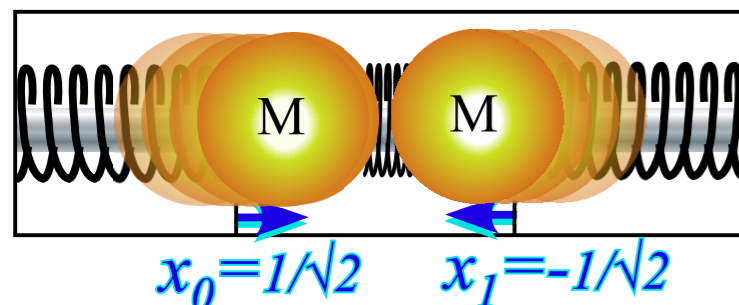

Mode state projection:

$$|+\rangle = |0_2\rangle = \mathbf{P}^{(+)}|0\rangle\sqrt{2}$$

$$= (|0\rangle + |2\rangle)/\sqrt{2}$$

$$= (|\mathbf{1}\rangle + |\sigma_B\rangle)/\sqrt{2}$$

$$|-\rangle = |1_2\rangle = \mathbf{P}^{(-)}|0\rangle\sqrt{2}$$

$$= (|0\rangle - |2\rangle)/\sqrt{2}$$

$$= (|\mathbf{1}\rangle - |\sigma_B\rangle)/\sqrt{2}$$

$(\sigma_B)^2 = \mathbf{1}$ or: $(\sigma_B)^2 - \mathbf{1} = \mathbf{0}$ gives projectors:

$$(\sigma_B + \mathbf{1}) \cdot (\sigma_B - \mathbf{1}) = \mathbf{0} = \mathbf{p}^{(+1)} \cdot \mathbf{p}^{(-1)}$$

$$\mathbf{P}^{(+)} = (\mathbf{1} + \sigma_B)/2 \text{ and } \mathbf{P}^{(-)} = (\mathbf{1} - \sigma_B)/2$$

(Normed so: $\mathbf{P}^{(+)} + \mathbf{P}^{(-)} = \mathbf{1}$ and: $\mathbf{P}^{(m)} \cdot \mathbf{P}^{(m)} = \mathbf{P}^{(m)}$)

Wave resonance in cyclic symmetry

Harmonic oscillator with cyclic C_2 symmetry (B-type)

Hamiltonian matrix \mathbf{H} or spring-constant matrix $\mathbf{K}=\mathbf{H}^2$ with B-type or *bilateral-balanced* symmetry

$$\mathbf{H} = \begin{pmatrix} A & B \\ B & A \end{pmatrix} = A \begin{pmatrix} 1 & 0 \\ 0 & 1 \end{pmatrix} + B \begin{pmatrix} 0 & 1 \\ 1 & 0 \end{pmatrix}$$

$$= A \cdot \mathbf{1} + B \cdot \sigma_B$$

$$\mathbf{K} = \mathbf{H}^2 = \begin{pmatrix} A^2 + B^2 & 2AB \\ 2AB & A^2 + B^2 \end{pmatrix}$$

$$= (A^2 + B^2) \cdot \mathbf{1} + 2AB \cdot \sigma_B$$

C_2	$\mathbf{1}$	σ_B
$\mathbf{1}$	$\mathbf{1}$	σ_B
σ_B	σ_B	$\mathbf{1}$

Reflection symmetry σ_B defined by $(\sigma_B)^2 = \mathbf{1}$ in C_2 group product table.

(a) unit base state $|\mathbf{1}\rangle = \mathbf{1}|\mathbf{1}\rangle$
 $|0\rangle = |x\rangle = |2\rangle = \begin{pmatrix} 1 \\ 0 \end{pmatrix}$

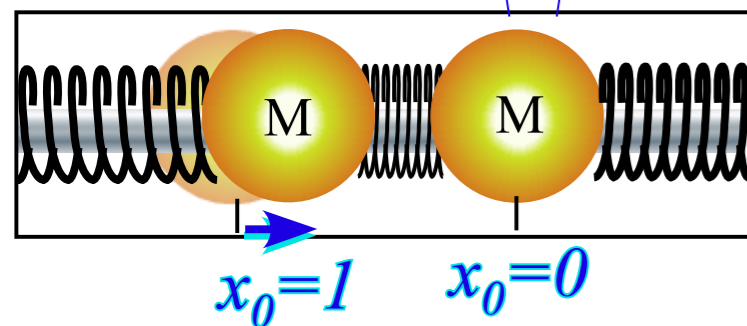

(b) unit base state $|\sigma_B\rangle = \sigma_B|\mathbf{1}\rangle$
 $|1\rangle = |y\rangle = |-1\rangle = \begin{pmatrix} 0 \\ 1 \end{pmatrix}$

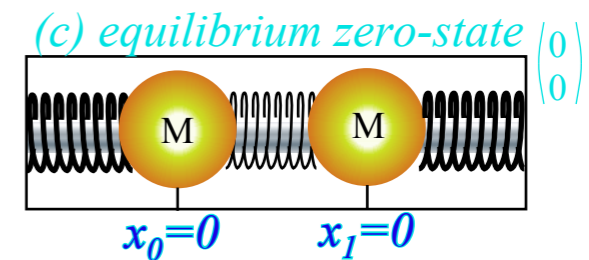
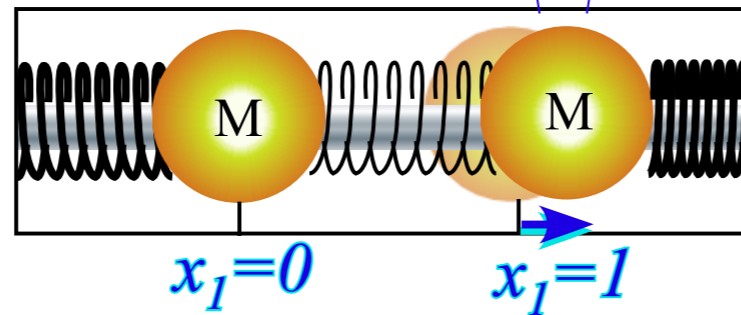

C_2 symmetry (B-type) modes

(a) Even mode $|+\rangle = |0_2\rangle = \frac{1}{\sqrt{2}} \begin{pmatrix} 1 \\ 1 \end{pmatrix}$

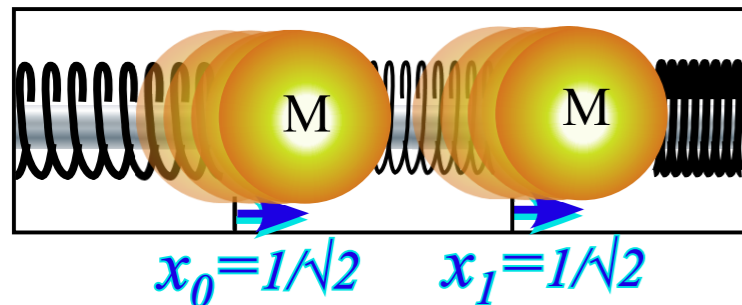

(b) Odd mode $|-\rangle = |1_2\rangle = \frac{1}{\sqrt{2}} \begin{pmatrix} 1 \\ -1 \end{pmatrix}$

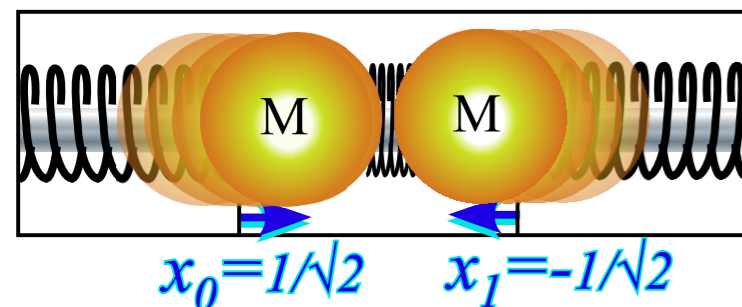

Mode state projection:

$$|+\rangle = |0_2\rangle = \mathbf{P}^{(+)}|0\rangle\sqrt{2}$$

$$= (|0\rangle + |2\rangle)/\sqrt{2}$$

$$= (|\mathbf{1}\rangle + |\sigma_B\rangle)/\sqrt{2}$$

$$|-\rangle = |1_2\rangle = \mathbf{P}^{(-)}|0\rangle\sqrt{2}$$

$$= (|0\rangle - |2\rangle)/\sqrt{2}$$

$$= (|\mathbf{1}\rangle - |\sigma_B\rangle)/\sqrt{2}$$

$(\sigma_B)^2 = \mathbf{1}$ or: $(\sigma_B)^2 - \mathbf{1} = 0$ gives projectors:

$$(\sigma_B + \mathbf{1}) \cdot (\sigma_B - \mathbf{1}) = 0 = \mathbf{p}^{(+)} \cdot \mathbf{p}^{(-)}$$

$$\mathbf{P}^{(+)} = (\mathbf{1} + \sigma_B)/2 \text{ and } \mathbf{P}^{(-)} = (\mathbf{1} - \sigma_B)/2$$

(Normed so: $\mathbf{P}^{(+)} + \mathbf{P}^{(-)} = \mathbf{1}$ and: $\mathbf{P}^{(m)} \cdot \mathbf{P}^{(m)} = \mathbf{P}^{(m)}$)

C_2 mode phase & character tables

$p = \text{position point (modulo-2)}$

$p=0$	$p=1$	$m=0$	1	1
$p=0$	$p=1$	$m=1$	1	-1

State norm: $1/\sqrt{2}$ $m = \text{wave-number or "momentum" (modulo-2)}$ Operator norm: $1/2$

Wave resonance in cyclic symmetry

Harmonic oscillator with cyclic C_2 symmetry

C_2 symmetric (B-type) modes

➔ *Harmonic oscillator with cyclic C_3 symmetry*

C_3 symmetric spectral decomposition by 3rd roots of unity

Resolving C_3 projectors and moving wave modes

Dispersion functions and standing waves

C_6 symmetric mode model: Distant neighbor coupling

C_6 spectra of gauge splitting by C-type symmetry (complex, chiral, coriolis, current, .

C_N symmetric mode models: Made-to order dispersion functions

Quadratic dispersion models: Super-beats and fractional revivals

Phase arithmetic

Wave resonance in cyclic symmetry

Harmonic oscillator with cyclic C_3 symmetry

3-fold $\pm 120^\circ$ rotations $\mathbf{r}=\mathbf{r}^1$ and $(\mathbf{r})^2=\mathbf{r}^2=\mathbf{r}^{-1}$

obey: $(\mathbf{r})^3=\mathbf{r}^3=\mathbf{1}=\mathbf{r}^0$ and a C_3 $\mathbf{g}^\dagger\mathbf{g}$ -product-table

C_3	$\mathbf{r}^0=\mathbf{1}$	$\mathbf{r}^1=\mathbf{r}^{-2}$	$\mathbf{r}^2=\mathbf{r}^{-1}$
$\mathbf{r}^0=\mathbf{1}$	$\mathbf{1}$	\mathbf{r}^1	\mathbf{r}^2
$\mathbf{r}^2=\mathbf{r}^{-1}$	\mathbf{r}^2	$\mathbf{1}$	\mathbf{r}^1
$\mathbf{r}^1=\mathbf{r}^{-2}$	\mathbf{r}^1	\mathbf{r}^2	$\mathbf{1}$

$\mathbf{g}=\mathbf{r}^p$ heads p^{th} -column. Inverse $\mathbf{g}^\dagger=\mathbf{g}^{-1}$ heads p^{th} -row
then unit $\mathbf{g}^\dagger\mathbf{g}=\mathbf{1}=\mathbf{g}^{-1}\mathbf{g}$ occupies p^{th} -diagonal.

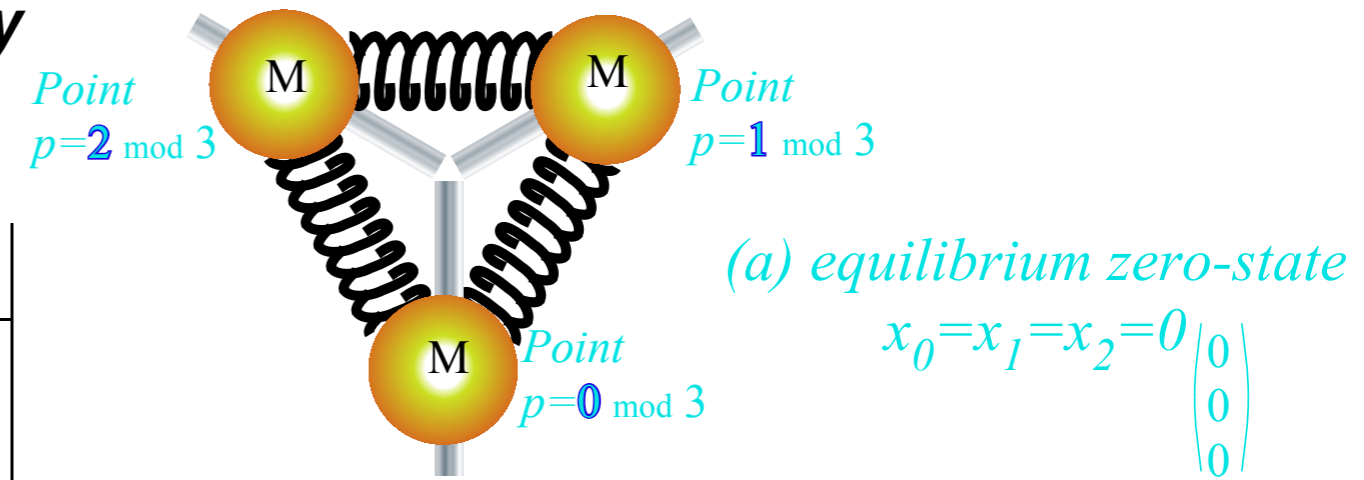

\mathbf{H} -matrix and each \mathbf{r}^p -matrix based on $\mathbf{g}^\dagger\mathbf{g}$ -table.

$$\begin{pmatrix} r_0 & r_1 & r_2 \\ r_2 & r_0 & r_1 \\ r_1 & r_2 & r_0 \end{pmatrix} = r_0 \begin{pmatrix} 1 & 0 & 0 \\ 0 & 1 & 0 \\ 0 & 0 & 1 \end{pmatrix} + r_1 \begin{pmatrix} 0 & 1 & 0 \\ 0 & 0 & 1 \\ 1 & 0 & 0 \end{pmatrix} + r_2 \begin{pmatrix} 0 & 0 & 1 \\ 1 & 0 & 0 \\ 0 & 1 & 0 \end{pmatrix}$$

$$\mathbf{H} = r_0 \cdot \mathbf{1} + r_1 \cdot \mathbf{r}^1 + r_2 \cdot \mathbf{r}^2$$

$\mathbf{r}^0=\mathbf{1}$

Fig. 4.8.1
Unit 4
CMwBang

Wave resonance in cyclic symmetry

Harmonic oscillator with cyclic C_3 symmetry

3-fold $\pm 120^\circ$ rotations $\mathbf{r}=\mathbf{r}^1$ and $(\mathbf{r})^2=\mathbf{r}^2=\mathbf{r}^{-1}$

obey: $(\mathbf{r})^3=\mathbf{r}^3=\mathbf{1}=\mathbf{r}^0$ and a C_3 $\mathbf{g}^\dagger\mathbf{g}$ -product-table

C_3	$\mathbf{r}^0=\mathbf{1}$	$\mathbf{r}^1=\mathbf{r}^{-2}$	$\mathbf{r}^2=\mathbf{r}^{-1}$
$\mathbf{r}^0=\mathbf{1}$	$\mathbf{1}$	\mathbf{r}^1	\mathbf{r}^2
$\mathbf{r}^2=\mathbf{r}^{-1}$	\mathbf{r}^2	$\mathbf{1}$	\mathbf{r}^1
$\mathbf{r}^1=\mathbf{r}^{-2}$	\mathbf{r}^1	\mathbf{r}^2	$\mathbf{1}$

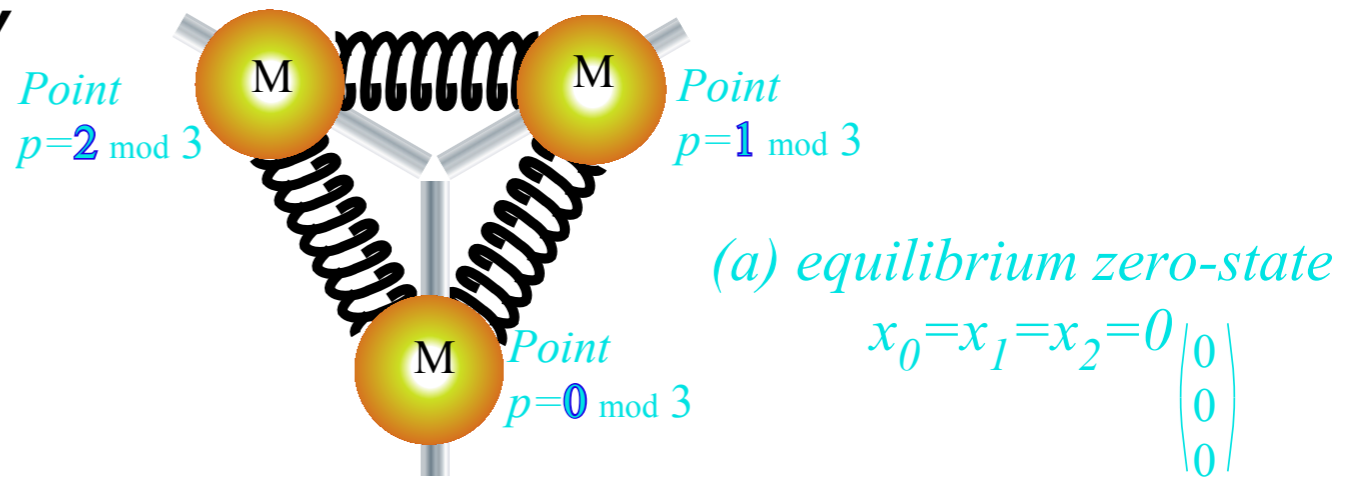

\mathbf{H} -matrix and each \mathbf{r}^p -matrix based on $\mathbf{g}^\dagger\mathbf{g}$ -table.

$\mathbf{g}=\mathbf{r}^p$ heads p^{th} -column. Inverse $\mathbf{g}^\dagger=\mathbf{g}^{-1}$ heads p^{th} -row then unit $\mathbf{g}^\dagger\mathbf{g}=\mathbf{1}=\mathbf{g}^{-1}\mathbf{g}$ occupies p^{th} -diagonal.

$$\begin{pmatrix} r_0 & r_1 & r_2 \\ r_2 & r_0 & r_1 \\ r_1 & r_2 & r_0 \end{pmatrix} = r_0 \begin{pmatrix} 1 & 0 & 0 \\ 0 & 1 & 0 \\ 0 & 0 & 1 \end{pmatrix} + r_1 \begin{pmatrix} 0 & 1 & 0 \\ 0 & 0 & 1 \\ 1 & 0 & 0 \end{pmatrix} + r_2 \begin{pmatrix} 0 & 0 & 1 \\ 1 & 0 & 0 \\ 0 & 1 & 0 \end{pmatrix}$$

$$\mathbf{H} = r_0 \cdot \mathbf{1} + r_1 \cdot \mathbf{r}^1 + r_2 \cdot \mathbf{r}^2$$

$\mathbf{r}^0=\mathbf{1}$

C_3 unit base states

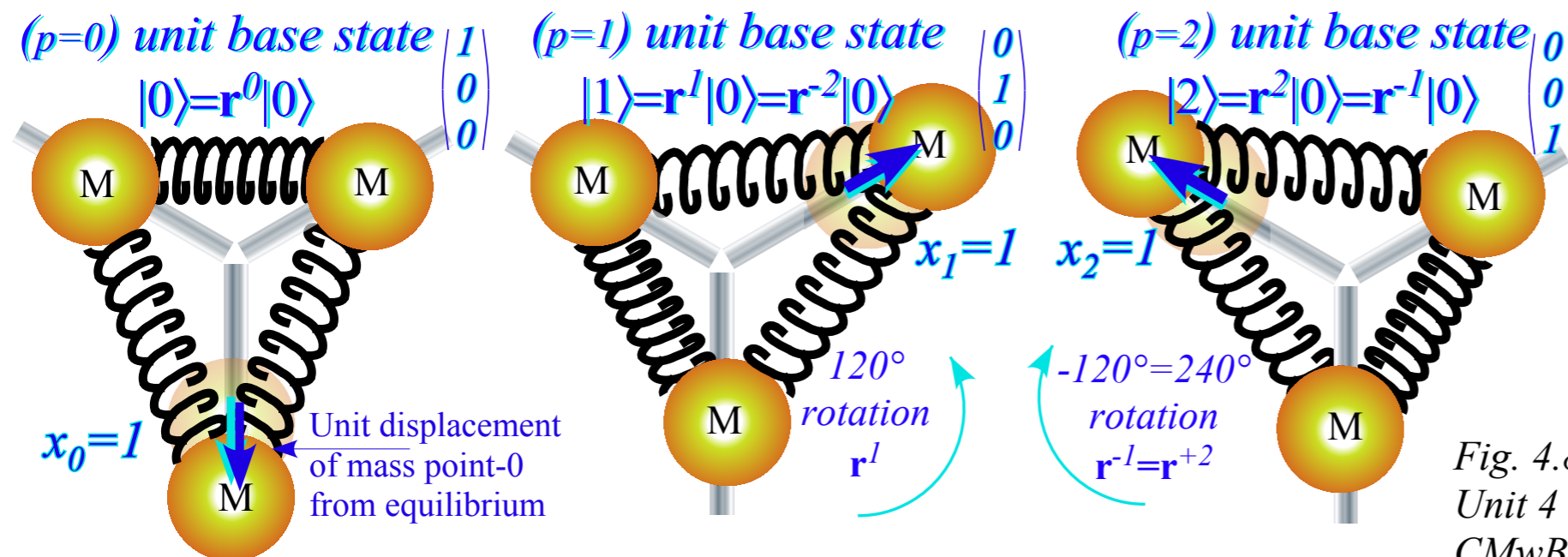

Fig. 4.8.1
 Unit 4
 CMwBang

Wave resonance in cyclic symmetry

Harmonic oscillator with cyclic C_3 symmetry

3-fold $\pm 120^\circ$ rotations $\mathbf{r}=\mathbf{r}^1$ and $(\mathbf{r})^2=\mathbf{r}^2=\mathbf{r}^{-1}$

obey: $(\mathbf{r})^3=\mathbf{r}^3=\mathbf{1}=\mathbf{r}^0$ and a C_3 $\mathbf{g}^\dagger\mathbf{g}$ -product-table

C_3	$\mathbf{r}^0=\mathbf{1}$	$\mathbf{r}^1=\mathbf{r}^{-2}$	$\mathbf{r}^2=\mathbf{r}^{-1}$
$\mathbf{r}^0=\mathbf{1}$	$\mathbf{1}$	\mathbf{r}^1	\mathbf{r}^2
$\mathbf{r}^2=\mathbf{r}^{-1}$	\mathbf{r}^2	$\mathbf{1}$	\mathbf{r}^1
$\mathbf{r}^1=\mathbf{r}^{-2}$	\mathbf{r}^1	\mathbf{r}^2	$\mathbf{1}$

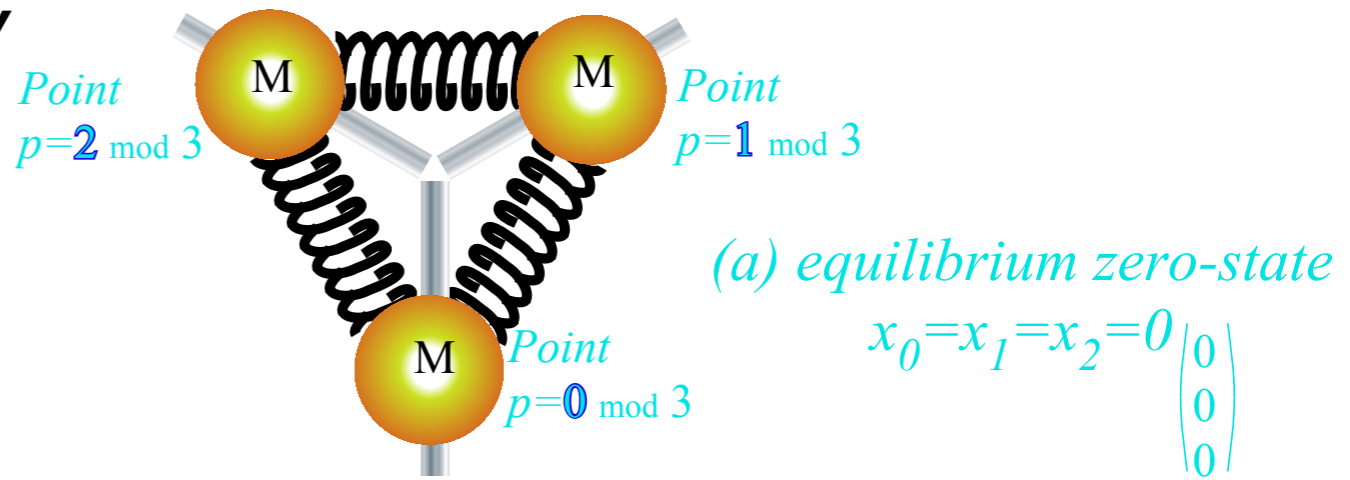

\mathbf{H} -matrix and each \mathbf{r}^p -matrix based on $\mathbf{g}^\dagger\mathbf{g}$ -table.

$\mathbf{g}=\mathbf{r}^p$ heads p^{th} -column. Inverse $\mathbf{g}^\dagger=\mathbf{g}^{-1}$ heads p^{th} -row then unit $\mathbf{g}^\dagger\mathbf{g}=\mathbf{1}=\mathbf{g}^{-1}\mathbf{g}$ occupies p^{th} -diagonal.

$$\begin{pmatrix} r_0 & r_1 & r_2 \\ r_2 & r_0 & r_1 \\ r_1 & r_2 & r_0 \end{pmatrix} = r_0 \begin{pmatrix} 1 & 0 & 0 \\ 0 & 1 & 0 \\ 0 & 0 & 1 \end{pmatrix} + r_1 \begin{pmatrix} 0 & 1 & 0 \\ 0 & 0 & 1 \\ 1 & 0 & 0 \end{pmatrix} + r_2 \begin{pmatrix} 0 & 0 & 1 \\ 1 & 0 & 0 \\ 0 & 1 & 0 \end{pmatrix}$$

$$\mathbf{H} = r_0 \cdot \mathbf{1} + r_1 \cdot \mathbf{r}^1 + r_2 \cdot \mathbf{r}^2$$

$\mathbf{r}^0=\mathbf{1}$

C_3 unit base states

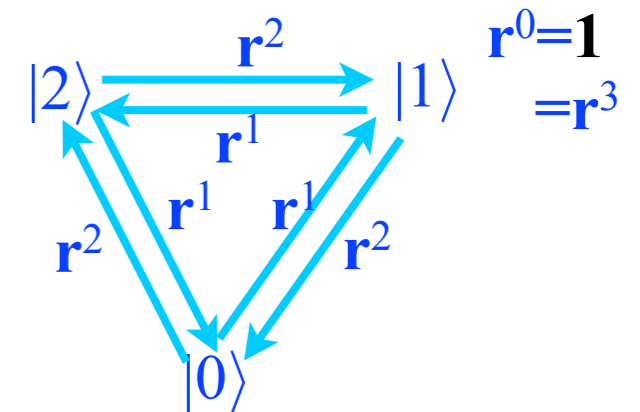
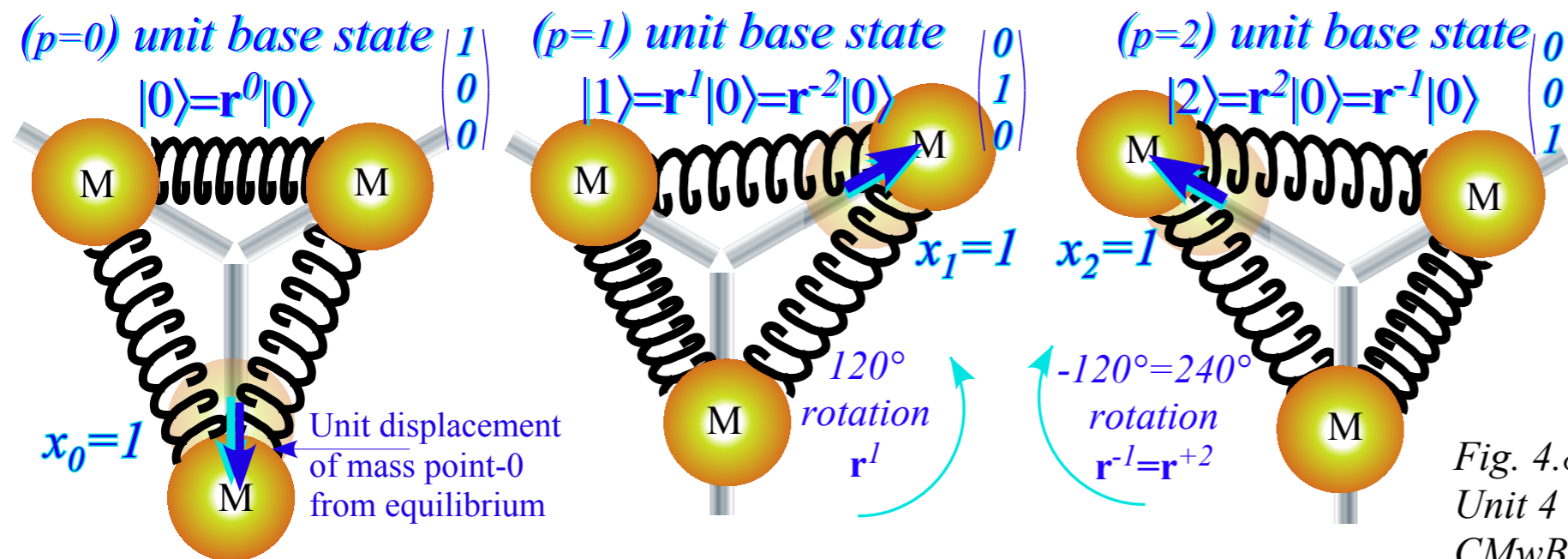

Fig. 4.8.1
 Unit 4
 CMwBang

Each \mathbf{H} -matrix coupling constant $r_p=\{r_0, r_1, r_2\}$ is amplitude of its operator power $\mathbf{r}^p=\{\mathbf{r}^0, \mathbf{r}^1, \mathbf{r}^2\}$

Wave resonance in cyclic symmetry

Harmonic oscillator with cyclic C_2 symmetry

C_2 symmetric (B-type) modes

Harmonic oscillator with cyclic C_3 symmetry

➔ *C_3 symmetric spectral decomposition by 3rd roots of unity*

Resolving C_3 projectors and moving wave modes

Dispersion functions and standing waves

C_6 symmetric mode model: Distant neighbor coupling

C_6 spectra of gauge splitting by C-type symmetry (complex, chiral, coriolis, current, ..)

C_N symmetric mode models: Made-to order dispersion functions

Quadratic dispersion models: Super-beats and fractional revivals

Phase arithmetic

C₃ Spectral resolution: 3rd roots of unity

We can spectrally resolve **H** if we resolve **r** since **H** is a combination $r_p \mathbf{r}^p$ of powers \mathbf{r}^p .

C₃ Spectral resolution: 3rd roots of unity

We can spectrally resolve \mathbf{H} if we resolve \mathbf{r} since \mathbf{H} is a combination $r_p \mathbf{r}^p$ of powers \mathbf{r}^p .

\mathbf{r} -symmetry is cubic $\mathbf{r}^3 = \mathbf{1}$, or $\mathbf{r}^3 - \mathbf{1} = \mathbf{0}$ and resolves to factors of *3rd roots of unity* $\rho_m = e^{im2\pi/3}$.

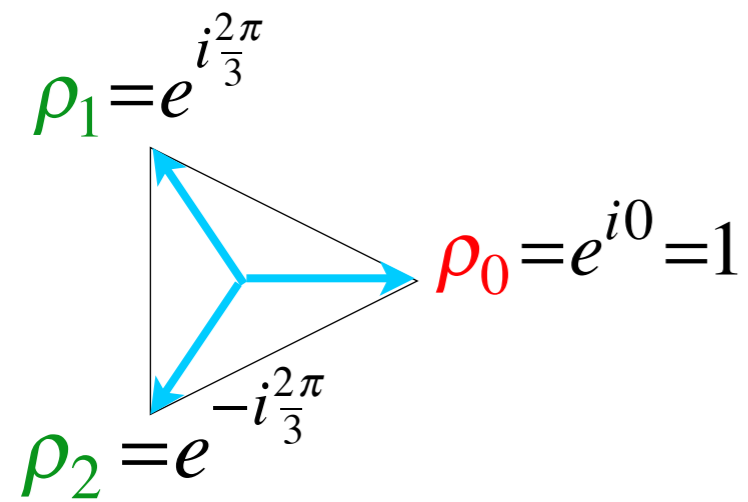

C₃ Spectral resolution: 3rd roots of unity

We can spectrally resolve \mathbf{H} if we resolve \mathbf{r} since \mathbf{H} is a combination $r_p \mathbf{r}^p$ of powers \mathbf{r}^p .

\mathbf{r} -symmetry is cubic $\mathbf{r}^3 = \mathbf{1}$, or $\mathbf{r}^3 - \mathbf{1} = \mathbf{0}$ and resolves to factors of *3rd roots of unity* $\rho_m = e^{im2\pi/3}$.

$$\mathbf{1} = \mathbf{r}^3 \text{ implies : } \mathbf{0} = \mathbf{r}^3 - \mathbf{1} = (\mathbf{r} - \rho_0 \mathbf{1})(\mathbf{r} - \rho_1 \mathbf{1})(\mathbf{r} - \rho_2 \mathbf{1}) \text{ where : } \rho_m = e^{im\frac{2\pi}{3}}$$

Each eigenvalue ρ_m of \mathbf{r} , has idempotent projector $\mathbf{P}^{(m)}$ such that $\mathbf{r} \cdot \mathbf{P}^{(m)} = \rho_m \mathbf{P}^{(m)}$.

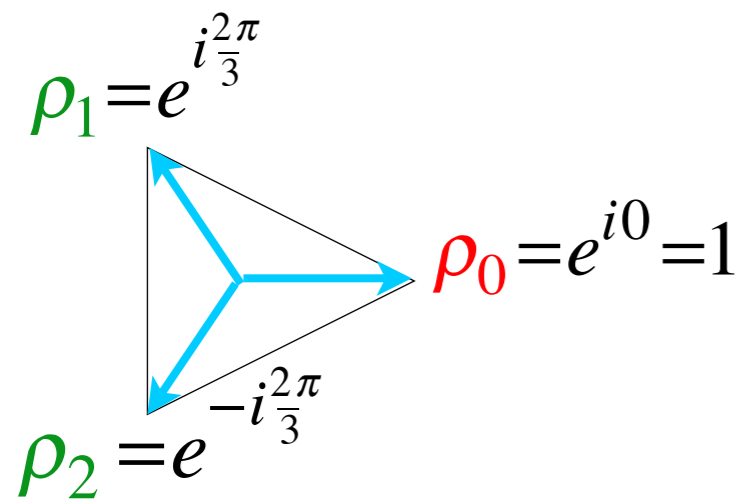

C₃ Spectral resolution: 3rd roots of unity

We can spectrally resolve \mathbf{H} if we resolve \mathbf{r} since \mathbf{H} is a combination $r_p \mathbf{r}^p$ of powers \mathbf{r}^p .

\mathbf{r} -symmetry is cubic $\mathbf{r}^3 = \mathbf{1}$, or $\mathbf{r}^3 - \mathbf{1} = \mathbf{0}$ and resolves to factors of *3rd roots of unity* $\rho_m = e^{im2\pi/3}$.

$$\mathbf{1} = \mathbf{r}^3 \text{ implies : } \mathbf{0} = \mathbf{r}^3 - \mathbf{1} = (\mathbf{r} - \rho_0 \mathbf{1})(\mathbf{r} - \rho_1 \mathbf{1})(\mathbf{r} - \rho_2 \mathbf{1}) \text{ where : } \rho_m = e^{im\frac{2\pi}{3}}$$

Each eigenvalue ρ_m of \mathbf{r} , has idempotent projector $\mathbf{P}^{(m)}$ such that $\mathbf{r} \cdot \mathbf{P}^{(m)} = \rho_m \mathbf{P}^{(m)}$.

All three $\mathbf{P}^{(m)}$ are *orthonormal* ($\mathbf{P}^{(m)} \mathbf{P}^{(n)} = \delta_{mn} \mathbf{P}^{(m)}$) and *complete* (sum to unit $\mathbf{1}$).

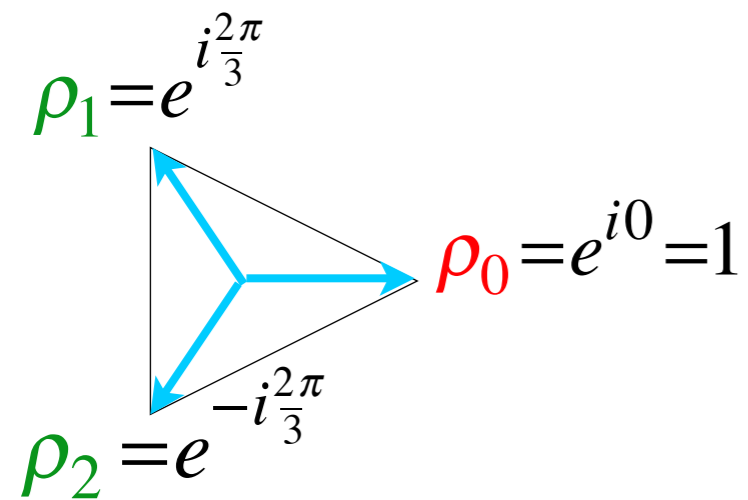

$$\mathbf{1} = \mathbf{P}^{(0)} + \mathbf{P}^{(1)} + \mathbf{P}^{(2)}$$

C₃ Spectral resolution: 3rd roots of unity

We can spectrally resolve \mathbf{H} if we resolve \mathbf{r} since \mathbf{H} is a combination $r_p \mathbf{r}^p$ of powers \mathbf{r}^p .

\mathbf{r} -symmetry is cubic $\mathbf{r}^3 = \mathbf{1}$, or $\mathbf{r}^3 - \mathbf{1} = \mathbf{0}$ and resolves to factors of *3rd roots of unity* $\rho_m = e^{im2\pi/3}$.

$$\mathbf{1} = \mathbf{r}^3 \text{ implies : } \mathbf{0} = \mathbf{r}^3 - \mathbf{1} = (\mathbf{r} - \rho_0 \mathbf{1})(\mathbf{r} - \rho_1 \mathbf{1})(\mathbf{r} - \rho_2 \mathbf{1}) \text{ where : } \rho_m = e^{im\frac{2\pi}{3}}$$

Each eigenvalue ρ_m of \mathbf{r} , has idempotent projector $\mathbf{P}^{(m)}$ such that $\mathbf{r} \cdot \mathbf{P}^{(m)} = \rho_m \mathbf{P}^{(m)}$.

All three $\mathbf{P}^{(m)}$ are *orthonormal* ($\mathbf{P}^{(m)} \mathbf{P}^{(n)} = \delta_{mn} \mathbf{P}^{(m)}$) and *complete* (sum to unit $\mathbf{1}$).

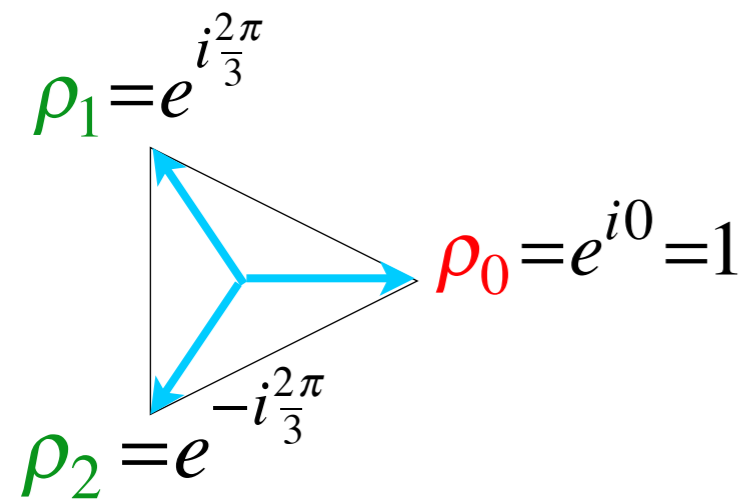

$$\mathbf{1} = \mathbf{P}^{(0)} + \mathbf{P}^{(1)} + \mathbf{P}^{(2)}$$

$$\mathbf{r} = \rho_0 \mathbf{P}^{(0)} + \rho_1 \mathbf{P}^{(1)} + \rho_2 \mathbf{P}^{(2)}$$

C₃ Spectral resolution: 3rd roots of unity

We can spectrally resolve \mathbf{H} if we resolve \mathbf{r} since \mathbf{H} is a combination $r_p \mathbf{r}^p$ of powers \mathbf{r}^p .

\mathbf{r} -symmetry is cubic $\mathbf{r}^3 = \mathbf{1}$, or $\mathbf{r}^3 - \mathbf{1} = \mathbf{0}$ and resolves to factors of *3rd roots of unity* $\rho_m = e^{im2\pi/3}$.

$$\mathbf{1} = \mathbf{r}^3 \text{ implies : } \mathbf{0} = \mathbf{r}^3 - \mathbf{1} = (\mathbf{r} - \rho_0 \mathbf{1})(\mathbf{r} - \rho_1 \mathbf{1})(\mathbf{r} - \rho_2 \mathbf{1}) \text{ where : } \rho_m = e^{im\frac{2\pi}{3}}$$

Each eigenvalue ρ_m of \mathbf{r} , has idempotent projector $\mathbf{P}^{(m)}$ such that $\mathbf{r} \cdot \mathbf{P}^{(m)} = \rho_m \mathbf{P}^{(m)}$.

All three $\mathbf{P}^{(m)}$ are *orthonormal* ($\mathbf{P}^{(m)} \mathbf{P}^{(n)} = \delta_{mn} \mathbf{P}^{(m)}$) and *complete* (sum to unit $\mathbf{1}$).

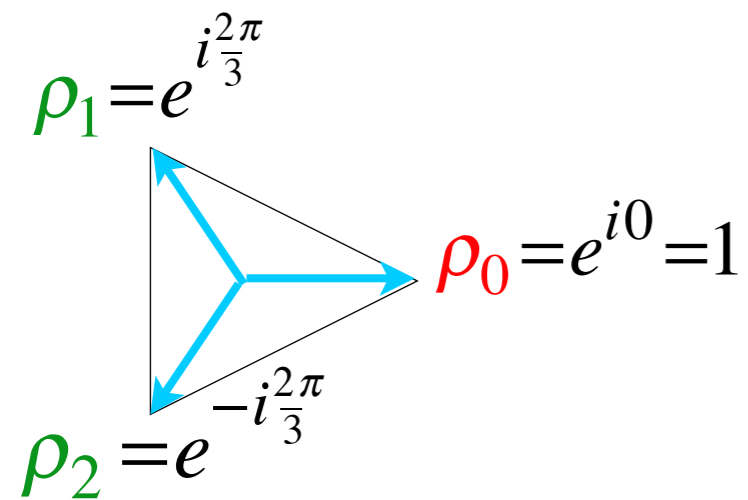

$$\mathbf{1} = \mathbf{P}^{(0)} + \mathbf{P}^{(1)} + \mathbf{P}^{(2)}$$

$$\mathbf{r} = \rho_0 \mathbf{P}^{(0)} + \rho_1 \mathbf{P}^{(1)} + \rho_2 \mathbf{P}^{(2)}$$

$$\mathbf{r}^2 = (\rho_0)^2 \mathbf{P}^{(0)} + (\rho_1)^2 \mathbf{P}^{(1)} + (\rho_2)^2 \mathbf{P}^{(2)}$$

C₃ Spectral resolution: 3rd roots of unity

We can spectrally resolve \mathbf{H} if we resolve \mathbf{r} since \mathbf{H} is a combination $r_p \mathbf{r}^p$ of powers \mathbf{r}^p .

\mathbf{r} -symmetry is cubic $\mathbf{r}^3 = \mathbf{1}$, or $\mathbf{r}^3 - \mathbf{1} = \mathbf{0}$ and resolves to factors of *3rd roots of unity* $\rho_m = e^{im2\pi/3}$.

$$\mathbf{1} = \mathbf{r}^3 \text{ implies : } \mathbf{0} = \mathbf{r}^3 - \mathbf{1} = (\mathbf{r} - \rho_0 \mathbf{1})(\mathbf{r} - \rho_1 \mathbf{1})(\mathbf{r} - \rho_2 \mathbf{1}) \text{ where : } \rho_m = e^{im\frac{2\pi}{3}}$$

Each eigenvalue ρ_m of \mathbf{r} , has idempotent projector $\mathbf{P}^{(m)}$ such that $\mathbf{r} \cdot \mathbf{P}^{(m)} = \rho_m \mathbf{P}^{(m)}$.

All three $\mathbf{P}^{(m)}$ are *orthonormal* ($\mathbf{P}^{(m)} \mathbf{P}^{(n)} = \delta_{mn} \mathbf{P}^{(m)}$) and *complete* (sum to unit $\mathbf{1}$).

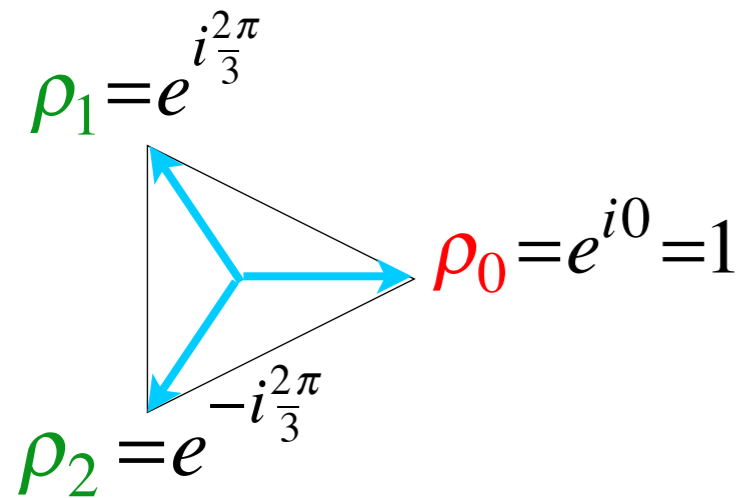

$$\mathbf{1} = \mathbf{P}^{(0)} + \mathbf{P}^{(1)} + \mathbf{P}^{(2)}$$

$$\mathbf{r} = \rho_0 \mathbf{P}^{(0)} + \rho_1 \mathbf{P}^{(1)} + \rho_2 \mathbf{P}^{(2)}$$

$$\mathbf{r}^2 = (\rho_0)^2 \mathbf{P}^{(0)} + (\rho_1)^2 \mathbf{P}^{(1)} + (\rho_2)^2 \mathbf{P}^{(2)}$$

Easy to resolve spectral projectors $\mathbf{P}^{(m)}$

$$\mathbf{P}^{(0)} = \frac{1}{3} (\mathbf{r}^0 + \mathbf{r}^1 + \mathbf{r}^2) = \frac{1}{3} (\mathbf{1} + \mathbf{r} + \mathbf{r}^2)$$

$$\mathbf{P}^{(1)} = \frac{1}{3} (\mathbf{r}^0 + \rho_1^* \mathbf{r}^1 + \rho_2^* \mathbf{r}^2) = \frac{1}{3} (\mathbf{1} + e^{-i2\pi/3} \mathbf{r} + e^{+i2\pi/3} \mathbf{r}^2)$$

$$\mathbf{P}^{(2)} = \frac{1}{3} (\mathbf{r}^0 + \rho_2^* \mathbf{r}^1 + \rho_1^* \mathbf{r}^2) = \frac{1}{3} (\mathbf{1} + e^{+i2\pi/3} \mathbf{r} + e^{-i2\pi/3} \mathbf{r}^2)$$

C₃ Spectral resolution: 3rd roots of unity

We can spectrally resolve **H** if we resolve **r** since **H** is a combination $r_p \mathbf{r}^p$ of powers \mathbf{r}^p .

r-symmetry is cubic $\mathbf{r}^3 = \mathbf{1}$, or $\mathbf{r}^3 - \mathbf{1} = \mathbf{0}$ and resolves to factors of *3rd roots of unity* $\rho_m = e^{im2\pi/3}$.

$$\mathbf{1} = \mathbf{r}^3 \text{ implies : } \mathbf{0} = \mathbf{r}^3 - \mathbf{1} = (\mathbf{r} - \rho_0 \mathbf{1})(\mathbf{r} - \rho_1 \mathbf{1})(\mathbf{r} - \rho_2 \mathbf{1}) \text{ where : } \rho_m = e^{im\frac{2\pi}{3}}$$

Each eigenvalue ρ_m of **r**, has idempotent projector $\mathbf{P}^{(m)}$ such that $\mathbf{r} \cdot \mathbf{P}^{(m)} = \rho_m \mathbf{P}^{(m)}$.

All three $\mathbf{P}^{(m)}$ are *orthonormal* ($\mathbf{P}^{(m)} \mathbf{P}^{(n)} = \delta_{mn} \mathbf{P}^{(m)}$) and *complete* (sum to unit **1**).

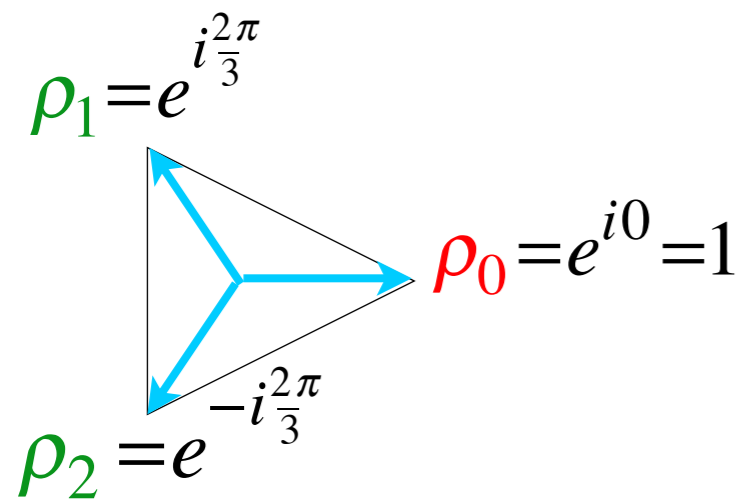

$$\mathbf{1} = \mathbf{P}^{(0)} + \mathbf{P}^{(1)} + \mathbf{P}^{(2)}$$

$$\mathbf{r} = \rho_0 \mathbf{P}^{(0)} + \rho_1 \mathbf{P}^{(1)} + \rho_2 \mathbf{P}^{(2)}$$

$$\mathbf{r}^2 = (\rho_0)^2 \mathbf{P}^{(0)} + (\rho_1)^2 \mathbf{P}^{(1)} + (\rho_2)^2 \mathbf{P}^{(2)}$$

Easy to resolve spectral projectors $\mathbf{P}^{(m)}$ and eigen-bra-vectors $\langle (m) |$

$$\mathbf{P}^{(0)} = \frac{1}{3} (\mathbf{r}^0 + \mathbf{r}^1 + \mathbf{r}^2) = \frac{1}{3} (\mathbf{1} + \mathbf{r} + \mathbf{r}^2)$$

$$\mathbf{P}^{(1)} = \frac{1}{3} (\mathbf{r}^0 + \rho_1^* \mathbf{r}^1 + \rho_2^* \mathbf{r}^2) = \frac{1}{3} (\mathbf{1} + e^{-i2\pi/3} \mathbf{r} + e^{+i2\pi/3} \mathbf{r}^2)$$

$$\mathbf{P}^{(2)} = \frac{1}{3} (\mathbf{r}^0 + \rho_2^* \mathbf{r}^1 + \rho_1^* \mathbf{r}^2) = \frac{1}{3} (\mathbf{1} + e^{+i2\pi/3} \mathbf{r} + e^{-i2\pi/3} \mathbf{r}^2)$$

$$\langle (0_3) | = \langle 0 | \mathbf{P}^{(0)} \sqrt{3} = \sqrt{\frac{1}{3}} (1 \quad 1 \quad 1)$$

$$\langle (1_3) | = \langle 0 | \mathbf{P}^{(1)} \sqrt{3} = \sqrt{\frac{1}{3}} (1 \quad e^{-i2\pi/3} \quad e^{+i2\pi/3})$$

$$\langle (2_3) | = \langle 0 | \mathbf{P}^{(2)} \sqrt{3} = \sqrt{\frac{1}{3}} (1 \quad e^{+i2\pi/3} \quad e^{-i2\pi/3})$$

(m_3) means: *m-modulo-3* (Details follow)

Wave resonance in cyclic symmetry

Harmonic oscillator with cyclic C_2 symmetry

C_2 symmetric (B-type) modes

Harmonic oscillator with cyclic C_3 symmetry

C_3 symmetric spectral decomposition by 3rd roots of unity

➔ *Resolving C_3 projectors and moving wave modes*

Dispersion functions and standing waves

C_6 symmetric mode model: Distant neighbor coupling

C_6 spectra of gauge splitting by C-type symmetry (complex, chiral, coriolis, current, ..)

C_N symmetric mode models: Made-to order dispersion functions

Quadratic dispersion models: Super-beats and fractional revivals

Phase arithmetic

Easy to resolve spectral projectors $\mathbf{P}^{(m)}$ and eigen-bra-vectors $\langle (m)_3 |$

$$\mathbf{P}^{(0)} = \frac{1}{3}(\mathbf{r}^0 + \mathbf{r}^1 + \mathbf{r}^2) = \frac{1}{3}(\mathbf{1} + \mathbf{r}^1 + \mathbf{r}^2)$$

$$\mathbf{P}^{(1)} = \frac{1}{3}(\mathbf{r}^0 + \rho_1^* \mathbf{r}^1 + \rho_2^* \mathbf{r}^2) = \frac{1}{3}(\mathbf{1} + e^{-i2\pi/3} \mathbf{r}^1 + e^{+i2\pi/3} \mathbf{r}^2)$$

$$\mathbf{P}^{(2)} = \frac{1}{3}(\mathbf{r}^0 + \rho_2^* \mathbf{r}^1 + \rho_1^* \mathbf{r}^2) = \frac{1}{3}(\mathbf{1} + e^{+i2\pi/3} \mathbf{r}^1 + e^{-i2\pi/3} \mathbf{r}^2)$$

$$\langle (0_3) | = \langle 0 | \mathbf{P}^{(0)} \sqrt{3} = \sqrt{\frac{1}{3}} (1 \quad 1 \quad 1)$$

$$\langle (1_3) | = \langle 0 | \mathbf{P}^{(1)} \sqrt{3} = \sqrt{\frac{1}{3}} (1 \quad e^{-i2\pi/3} \quad e^{+i2\pi/3})$$

$$\langle (2_3) | = \langle 0 | \mathbf{P}^{(2)} \sqrt{3} = \sqrt{\frac{1}{3}} (1 \quad e^{+i2\pi/3} \quad e^{-i2\pi/3})$$

(m_3) means: *m-modulo-3* (Details follow)

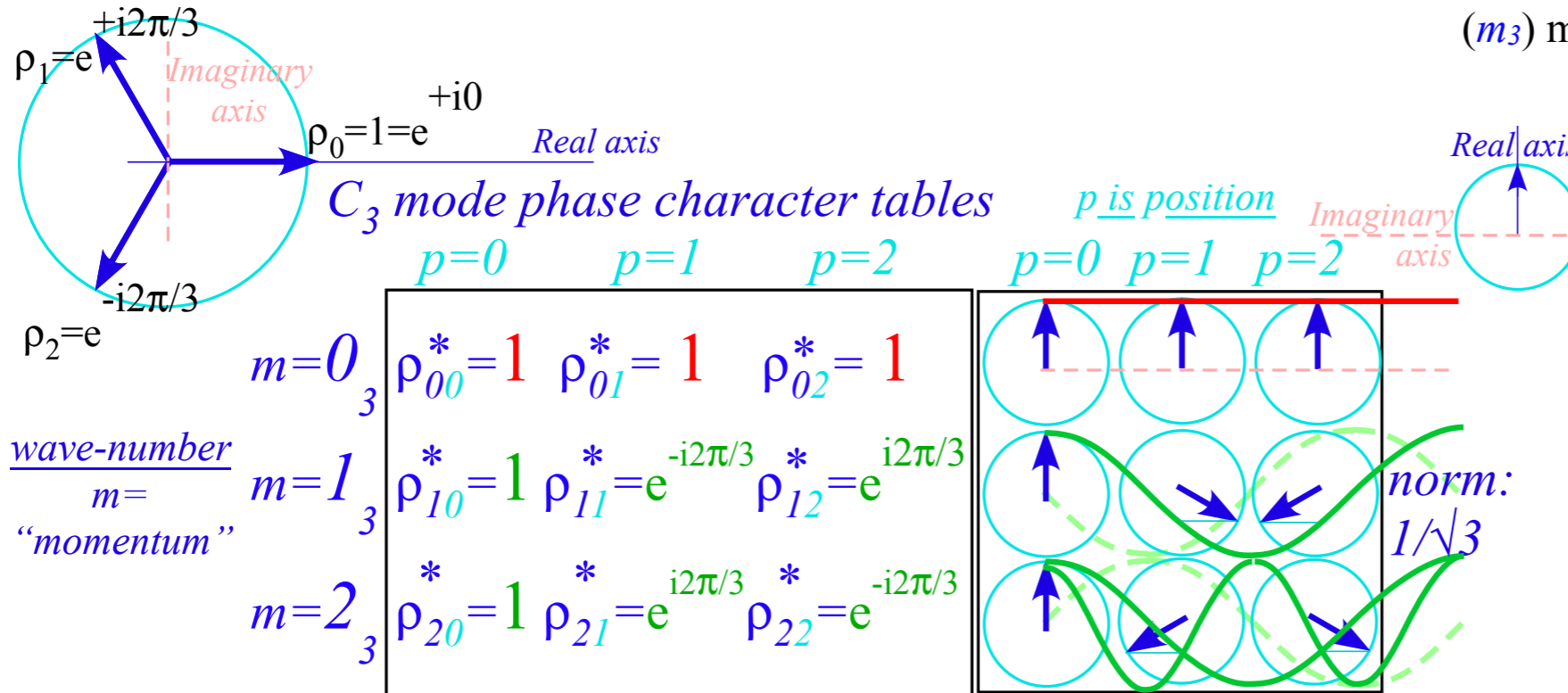

Easy to resolve spectral projectors $\mathbf{P}^{(m)}$ and eigen-bra-vectors $\langle (m) |$

$$\mathbf{P}^{(0)} = \frac{1}{3}(\mathbf{r}^0 + \mathbf{r}^1 + \mathbf{r}^2) = \frac{1}{3}(\mathbf{1} + \mathbf{r}^1 + \mathbf{r}^2)$$

$$\mathbf{P}^{(1)} = \frac{1}{3}(\mathbf{r}^0 + \rho_1^* \mathbf{r}^1 + \rho_2^* \mathbf{r}^2) = \frac{1}{3}(\mathbf{1} + e^{-i2\pi/3} \mathbf{r}^1 + e^{+i2\pi/3} \mathbf{r}^2)$$

$$\mathbf{P}^{(2)} = \frac{1}{3}(\mathbf{r}^0 + \rho_2^* \mathbf{r}^1 + \rho_1^* \mathbf{r}^2) = \frac{1}{3}(\mathbf{1} + e^{+i2\pi/3} \mathbf{r}^1 + e^{-i2\pi/3} \mathbf{r}^2)$$

$$\langle (0_3) | = \langle 0 | \mathbf{P}^{(0)} \sqrt{3} = \sqrt{\frac{1}{3}} \begin{pmatrix} 1 & 1 & 1 \end{pmatrix}$$

$$\langle (1_3) | = \langle 0 | \mathbf{P}^{(1)} \sqrt{3} = \sqrt{\frac{1}{3}} \begin{pmatrix} 1 & e^{-i2\pi/3} & e^{+i2\pi/3} \end{pmatrix}$$

$$\langle (2_3) | = \langle 0 | \mathbf{P}^{(2)} \sqrt{3} = \sqrt{\frac{1}{3}} \begin{pmatrix} 1 & e^{+i2\pi/3} & e^{-i2\pi/3} \end{pmatrix}$$

(m_3) means: m -modulo-3 (Details follow)

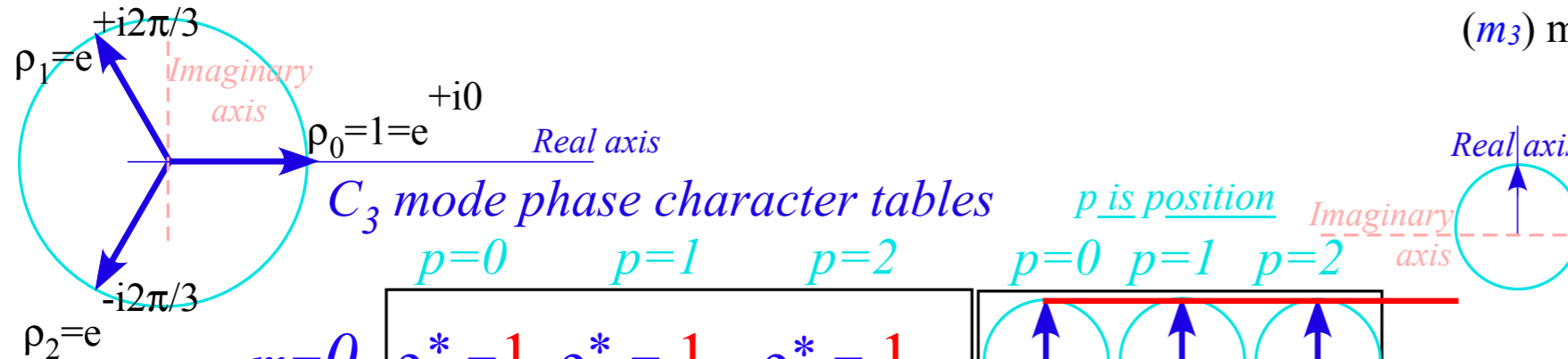

wave-number
 $m =$
"momentum"

$m=0$
 $m=1$
 $m=2$

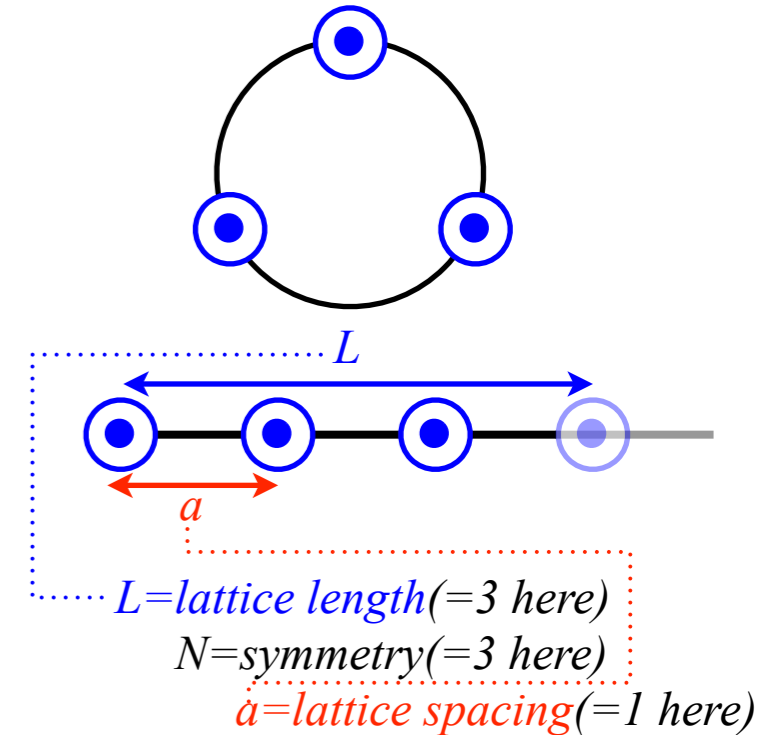
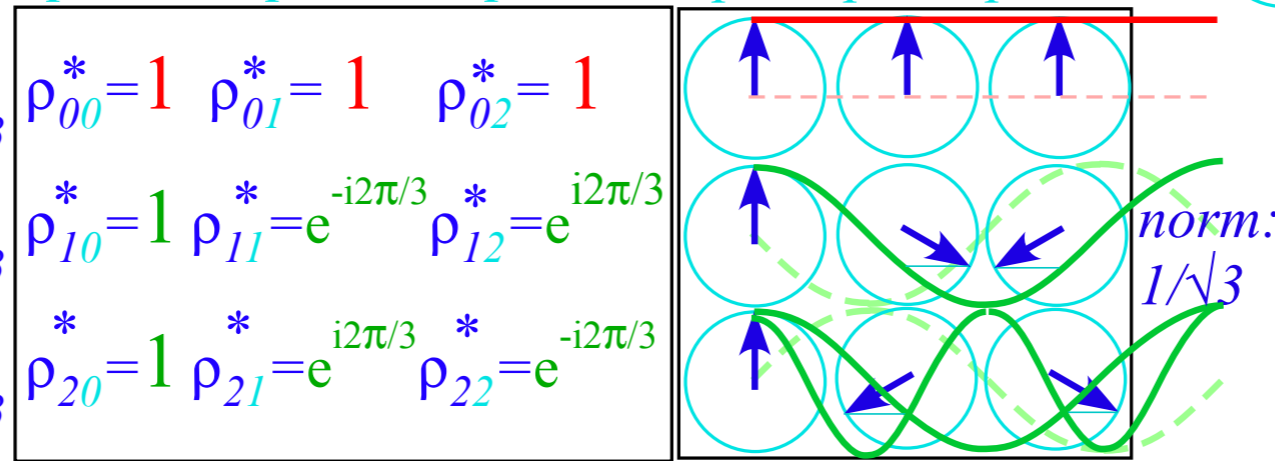

Easy to resolve spectral projectors $\mathbf{P}^{(m)}$ and eigen-bra-vectors $\langle (m) |$

$$\mathbf{P}^{(0)} = \frac{1}{3}(\mathbf{r}^0 + \mathbf{r}^1 + \mathbf{r}^2) = \frac{1}{3}(\mathbf{1} + \mathbf{r}^1 + \mathbf{r}^2)$$

$$\mathbf{P}^{(1)} = \frac{1}{3}(\mathbf{r}^0 + \rho_1^* \mathbf{r}^1 + \rho_2^* \mathbf{r}^2) = \frac{1}{3}(\mathbf{1} + e^{-i2\pi/3} \mathbf{r}^1 + e^{+i2\pi/3} \mathbf{r}^2)$$

$$\mathbf{P}^{(2)} = \frac{1}{3}(\mathbf{r}^0 + \rho_2^* \mathbf{r}^1 + \rho_1^* \mathbf{r}^2) = \frac{1}{3}(\mathbf{1} + e^{+i2\pi/3} \mathbf{r}^1 + e^{-i2\pi/3} \mathbf{r}^2)$$

$$\langle (0_3) | = \langle 0 | \mathbf{P}^{(0)} \sqrt{3} = \sqrt{\frac{1}{3}} (1 \quad 1 \quad 1)$$

$$\langle (1_3) | = \langle 0 | \mathbf{P}^{(1)} \sqrt{3} = \sqrt{\frac{1}{3}} (1 \quad e^{-i2\pi/3} \quad e^{+i2\pi/3})$$

$$\langle (2_3) | = \langle 0 | \mathbf{P}^{(2)} \sqrt{3} = \sqrt{\frac{1}{3}} (1 \quad e^{+i2\pi/3} \quad e^{-i2\pi/3})$$

(m_3) means: m -modulo-3 (Details follow)

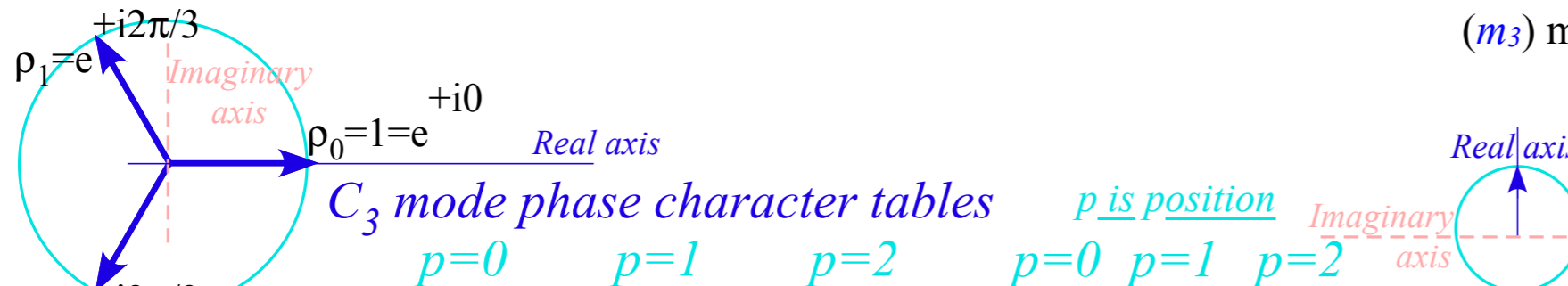

C_3 mode phase character tables

wave-number
 $m =$
"momentum"

	$p=0$	$p=1$	$p=2$
$m=0$	$\rho_{00}^* = 1$	$\rho_{01}^* = 1$	$\rho_{02}^* = 1$
$m=1$	$\rho_{10}^* = 1$	$\rho_{11}^* = e^{-i2\pi/3}$	$\rho_{12}^* = e^{i2\pi/3}$
$m=2$	$\rho_{20}^* = 1$	$\rho_{21}^* = e^{i2\pi/3}$	$\rho_{22}^* = e^{-i2\pi/3}$

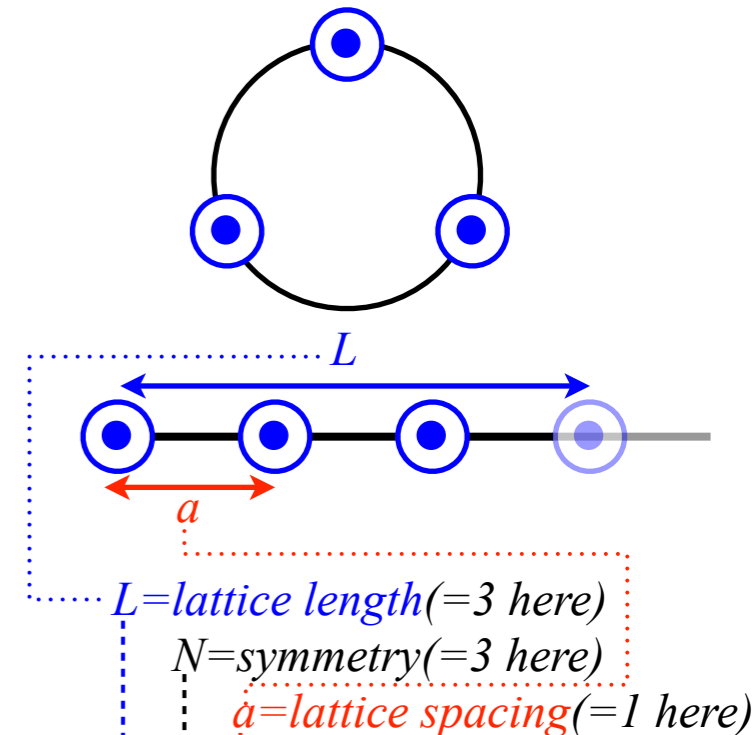
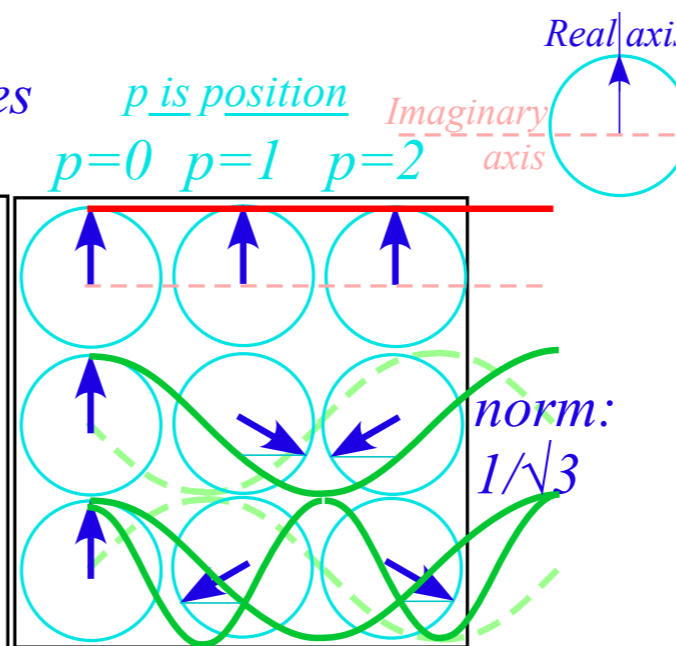

Two distinct types of "quantum" numbers.

$p=0,1,$ or 2 is *power* p of operator \mathbf{r}^p and defines each oscillator's *position point* p .

$m=0,1,$ or 2 is *mode momentum* m of the waves or wavevector $k_m = 2\pi/\lambda_m = 2\pi m/L$. ($L = Na = 3$)
wavelength $\lambda_m = 2\pi/k_m = L/m$

Easy to resolve spectral projectors $\mathbf{P}^{(m)}$ and eigen-bra-vectors $\langle (m) |$

$$\mathbf{P}^{(0)} = \frac{1}{3}(\mathbf{r}^0 + \mathbf{r}^1 + \mathbf{r}^2) = \frac{1}{3}(\mathbf{1} + \mathbf{r}^1 + \mathbf{r}^2)$$

$$\mathbf{P}^{(1)} = \frac{1}{3}(\mathbf{r}^0 + \rho_1^* \mathbf{r}^1 + \rho_2^* \mathbf{r}^2) = \frac{1}{3}(\mathbf{1} + e^{-i2\pi/3} \mathbf{r}^1 + e^{+i2\pi/3} \mathbf{r}^2)$$

$$\mathbf{P}^{(2)} = \frac{1}{3}(\mathbf{r}^0 + \rho_2^* \mathbf{r}^1 + \rho_1^* \mathbf{r}^2) = \frac{1}{3}(\mathbf{1} + e^{+i2\pi/3} \mathbf{r}^1 + e^{-i2\pi/3} \mathbf{r}^2)$$

$$\langle (0_3) | = \langle 0 | \mathbf{P}^{(0)} \sqrt{3} = \sqrt{\frac{1}{3}} (1 \quad 1 \quad 1)$$

$$\langle (1_3) | = \langle 0 | \mathbf{P}^{(1)} \sqrt{3} = \sqrt{\frac{1}{3}} (1 \quad e^{-i2\pi/3} \quad e^{+i2\pi/3})$$

$$\langle (2_3) | = \langle 0 | \mathbf{P}^{(2)} \sqrt{3} = \sqrt{\frac{1}{3}} (1 \quad e^{+i2\pi/3} \quad e^{-i2\pi/3})$$

(m_3) means: *m-modulo-3* (Details follow)

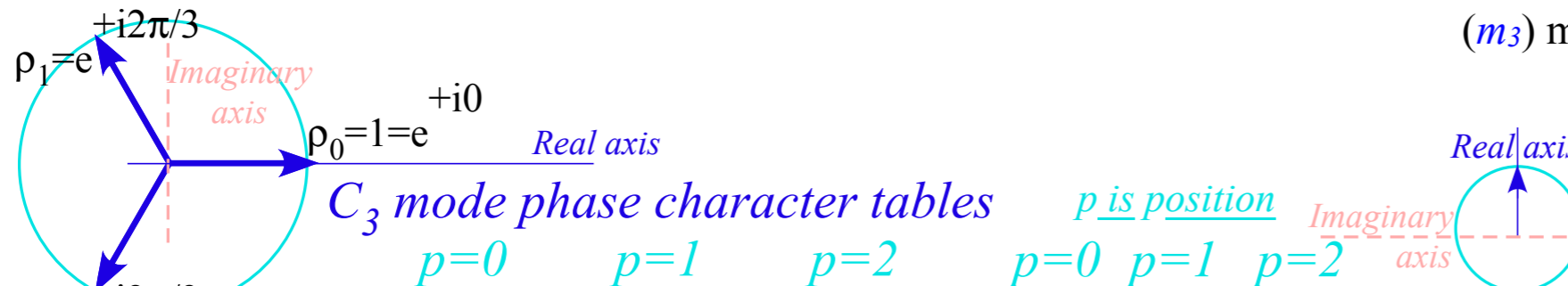

wave-number $m =$ "momentum"	p is position		
	$p=0$	$p=1$	$p=2$
$m=0_3$	$\rho_{00}^* = 1$	$\rho_{01}^* = 1$	$\rho_{02}^* = 1$
$m=1_3$	$\rho_{10}^* = 1$	$\rho_{11}^* = e^{-i2\pi/3}$	$\rho_{12}^* = e^{i2\pi/3}$
$m=2_3$	$\rho_{20}^* = 1$	$\rho_{21}^* = e^{i2\pi/3}$	$\rho_{22}^* = e^{-i2\pi/3}$

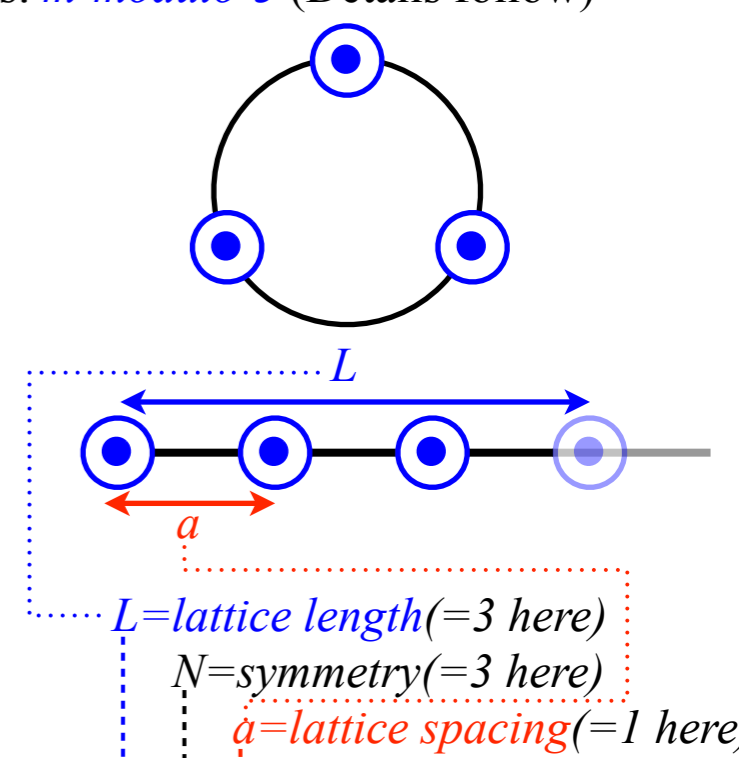
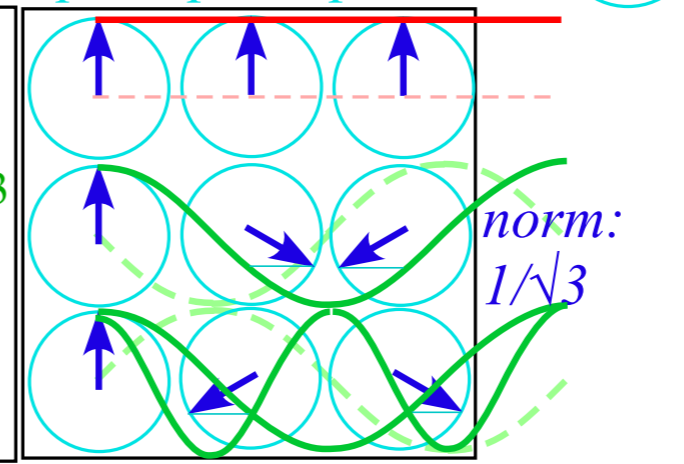

Two distinct types of "quantum" numbers.

$p=0,1,$ or 2 is *power p* of operator \mathbf{r}^p and defines each oscillator's *position point p*.

$m=0,1,$ or 2 is *mode momentum m* of the waves or wavevector $k_m = 2\pi/\lambda_m = 2\pi m/L$. ($L = Na = 3$)
wavelength $\lambda_m = 2\pi/k_m = L/m$

Each quantum number follows *modular arithmetic*: sums or products are an *integer-modulo-3*, that is, always $0,1,$ or 2 , or else $-1,0,$ or 1 , or else $-2,-1,$ or 0 , etc., depending on choice of origin.

Easy to resolve spectral projectors $\mathbf{P}^{(m)}$ and eigen-bra-vectors $\langle (m) |$

$$\mathbf{P}^{(0)} = \frac{1}{3}(\mathbf{r}^0 + \mathbf{r}^1 + \mathbf{r}^2) = \frac{1}{3}(\mathbf{1} + \mathbf{r}^1 + \mathbf{r}^2)$$

$$\mathbf{P}^{(1)} = \frac{1}{3}(\mathbf{r}^0 + \rho_1^* \mathbf{r}^1 + \rho_2^* \mathbf{r}^2) = \frac{1}{3}(\mathbf{1} + e^{-i2\pi/3} \mathbf{r}^1 + e^{+i2\pi/3} \mathbf{r}^2)$$

$$\mathbf{P}^{(2)} = \frac{1}{3}(\mathbf{r}^0 + \rho_2^* \mathbf{r}^1 + \rho_1^* \mathbf{r}^2) = \frac{1}{3}(\mathbf{1} + e^{+i2\pi/3} \mathbf{r}^1 + e^{-i2\pi/3} \mathbf{r}^2)$$

$$\langle (0_3) | = \langle 0 | \mathbf{P}^{(0)} \sqrt{3} = \sqrt{\frac{1}{3}} (1 \quad 1 \quad 1)$$

$$\langle (1_3) | = \langle 0 | \mathbf{P}^{(1)} \sqrt{3} = \sqrt{\frac{1}{3}} (1 \quad e^{-i2\pi/3} \quad e^{+i2\pi/3})$$

$$\langle (2_3) | = \langle 0 | \mathbf{P}^{(2)} \sqrt{3} = \sqrt{\frac{1}{3}} (1 \quad e^{+i2\pi/3} \quad e^{-i2\pi/3})$$

(m_3) means: m -modulo-3 (Details follow)

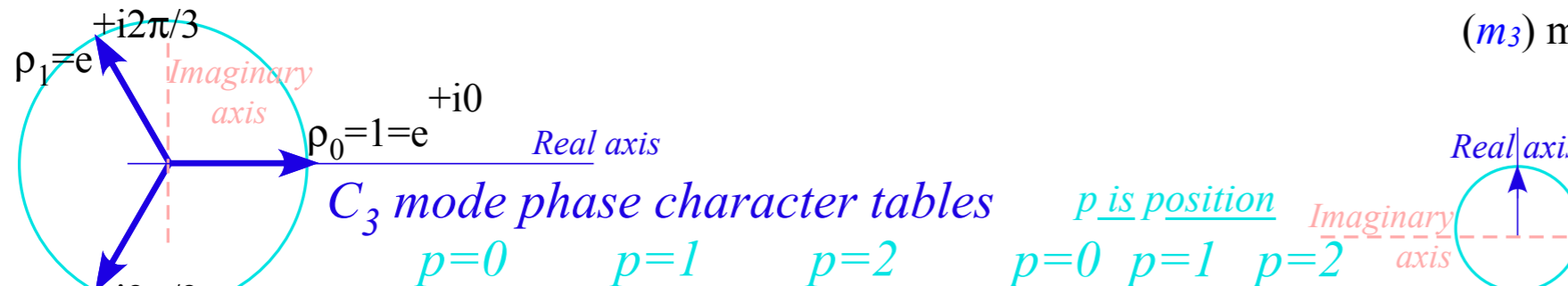

C_3 mode phase character tables

wave-number
 $m =$
"momentum"

	$p=0$	$p=1$	$p=2$
$m=0$	$\rho_{00}^* = 1$	$\rho_{01}^* = 1$	$\rho_{02}^* = 1$
$m=1$	$\rho_{10}^* = 1$	$\rho_{11}^* = e^{-i2\pi/3}$	$\rho_{12}^* = e^{i2\pi/3}$
$m=2$	$\rho_{20}^* = 1$	$\rho_{21}^* = e^{i2\pi/3}$	$\rho_{22}^* = e^{-i2\pi/3}$

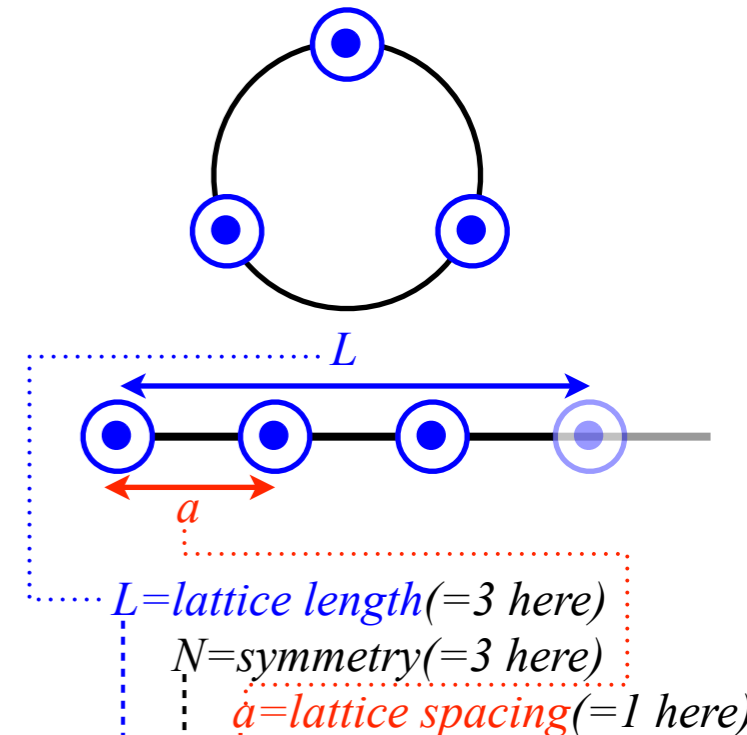
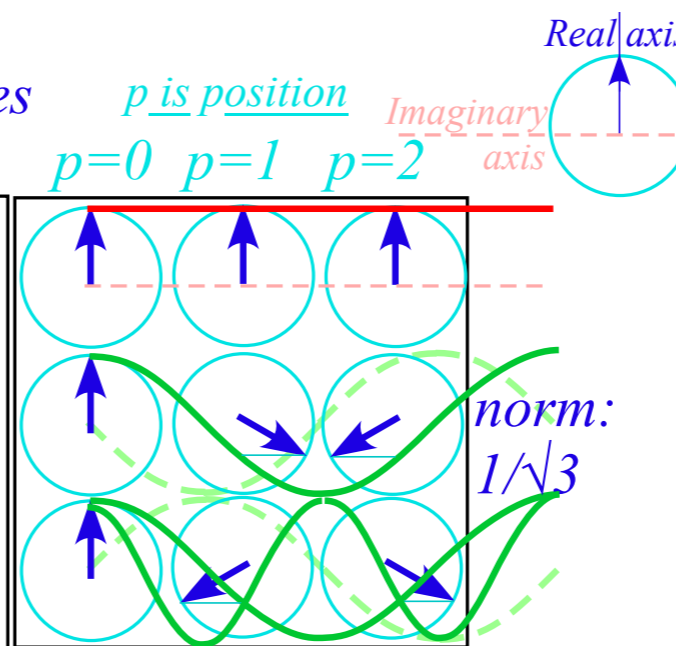

Two distinct types of "quantum" numbers.

$p=0,1,$ or 2 is *power* p of operator \mathbf{r}^p and defines each oscillator's *position point* p .

$m=0,1,$ or 2 is *mode momentum* m of the waves or wavevector $k_m = 2\pi/\lambda_m = 2\pi m/L$. ($L = Na = 3$)
wavelength $\lambda_m = 2\pi/k_m = L/m$

Each quantum number follows *modular arithmetic*: sums or products are an *integer-modulo-3*, that is, always $0,1,$ or 2 , or else $-1,0,$ or 1 , or else $-2,-1,$ or 0 , etc., depending on choice of origin.

For example, for $m=2$ and $p=2$ the number $(\rho_m)^p = (e^{im2\pi/3})^p$ is $e^{imp \cdot 2\pi/3} = e^{i4 \cdot 2\pi/3} = e^{i1 \cdot 2\pi/3} e^{i2\pi} = e^{i2\pi/3} = \rho_1$.
That is, $(2\text{-times-}2) \bmod 3$ is not 4 but 1 ($4 \bmod 3 = 1$, the remainder of 4 divided by 3 .)

Wave resonance in cyclic symmetry

Harmonic oscillator with cyclic C_2 symmetry

C_2 symmetric (B-type) modes

Harmonic oscillator with cyclic C_3 symmetry

C_3 symmetric spectral decomposition by 3rd roots of unity

Resolving C_3 projectors and moving wave modes

➔ *Dispersion functions and standing waves*

C_6 symmetric mode model: Distant neighbor coupling

C_6 spectra of gauge splitting by C-type symmetry (complex, chiral, coriolis, current, ..)

C_N symmetric mode models: Made-to order dispersion functions

Quadratic dispersion models: Super-beats and fractional revivals

Phase arithmetic

Easy to resolve spectral projectors $\mathbf{P}^{(m)}$ and eigenvalues ω_m or dispersion functions $\omega(k_m)$

$$\langle m | \mathbf{H} | m \rangle = \langle m | r_0 \mathbf{r}^0 + r_1 \mathbf{r}^1 + r_2 \mathbf{r}^2 | m \rangle = r_0 e^{i m \cdot 0 \frac{2\pi}{3}} + r_1 e^{i m \cdot 1 \frac{2\pi}{3}} + r_2 e^{i m \cdot 2 \frac{2\pi}{3}}$$

m^{th} Eigenvalue of \mathbf{r}^p

$$\langle m | \mathbf{r}^p | m \rangle = e^{i m \cdot p \frac{2\pi}{3}}$$

Easy to resolve spectral projectors $\mathbf{P}^{(m)}$ and eigenvalues ω_m or dispersion functions $\omega(k_m)$

$$\langle m | \mathbf{H} | m \rangle = \langle m | r_0 \mathbf{r}^0 + r_1 \mathbf{r}^1 + r_2 \mathbf{r}^2 | m \rangle = r_0 e^{i m \cdot 0 \frac{2\pi}{3}} + r_1 e^{i m \cdot 1 \frac{2\pi}{3}} + r_2 e^{i m \cdot 2 \frac{2\pi}{3}}$$

m^{th} Eigenvalue of \mathbf{r}^p

$$\langle m | \mathbf{r}^p | m \rangle = e^{i m \cdot p \frac{2\pi}{3}}$$

Easy to resolve spectral projectors $\mathbf{P}^{(m)}$ and eigenvalues ω_m or dispersion functions $\omega(k_m)$

$$\langle m | \mathbf{H} | m \rangle = \langle m | r_0 \mathbf{r}^0 + r_1 \mathbf{r}^1 + r_2 \mathbf{r}^2 | m \rangle = r_0 e^{i m \cdot 0 \frac{2\pi}{3}} + r_1 e^{i m \cdot 1 \frac{2\pi}{3}} + r_2 e^{i m \cdot 2 \frac{2\pi}{3}}$$

m^{th} Eigenvalue of \mathbf{r}^p

$$\langle m | \mathbf{r}^p | m \rangle = e^{i m \cdot p \frac{2\pi}{3}}$$

Easy to resolve spectral projectors $\mathbf{P}^{(m)}$ and eigenvalues ω_m or dispersion functions $\omega(k_m)$

$$\langle m | \mathbf{H} | m \rangle = \langle m | r_0 \mathbf{r}^0 + r_1 \mathbf{r}^1 + r_2 \mathbf{r}^2 | m \rangle = r_0 e^{i m \cdot 0 \frac{2\pi}{3}} + r_1 e^{i m \cdot 1 \frac{2\pi}{3}} + r_2 e^{i m \cdot 2 \frac{2\pi}{3}}$$

m^{th} Eigenvalue of \mathbf{r}^p

$$\langle m | \mathbf{r}^p | m \rangle = e^{i m \cdot p \frac{2\pi}{3}}$$

$$= r_0 e^{i m \cdot 0 \frac{2\pi}{3}} + r(e^{i \frac{2\pi m}{3}} + e^{-i \frac{2\pi m}{3}}) = r_0 + 2r \cos\left(\frac{2\pi m}{3}\right) = \begin{cases} r_0 + 2r & (\text{for } m = 0) \\ r_0 - r & (\text{for } m = \pm 1) \end{cases}$$

Easy to resolve spectral projectors $\mathbf{P}^{(m)}$ and eigenvalues ω_m or dispersion functions $\omega(k_m)$

$$\langle m | \mathbf{H} | m \rangle = \langle m | r_0 \mathbf{r}^0 + r_1 \mathbf{r}^1 + r_2 \mathbf{r}^2 | m \rangle = r_0 e^{i m \cdot 0 \frac{2\pi}{3}} + r_1 e^{i m \cdot 1 \frac{2\pi}{3}} + r_2 e^{i m \cdot 2 \frac{2\pi}{3}}$$

m^{th} Eigenvalue of \mathbf{r}^p

$$\langle m | \mathbf{r}^p | m \rangle = e^{i m \cdot p \frac{2\pi}{3}}$$

$$= r_0 e^{i m \cdot 0 \frac{2\pi}{3}} + r(e^{i \frac{2\pi m}{3}} + e^{-i \frac{2\pi m}{3}}) = r_0 + 2r \cos\left(\frac{2\pi m}{3}\right) = \begin{cases} r_0 + 2r & (\text{for } m = 0) \\ r_0 - r & (\text{for } m = \pm 1) \end{cases}$$

H-eigenvalues:

$$\begin{pmatrix} r_0 & r & r \\ r & r_0 & r \\ r & r & r_0 \end{pmatrix} \begin{pmatrix} 1 \\ e^{i \frac{2m\pi}{3}} \\ e^{-i \frac{2m\pi}{3}} \end{pmatrix} = (r_0 + 2r \cos(\frac{2m\pi}{3})) \begin{pmatrix} 1 \\ e^{i \frac{2m\pi}{3}} \\ e^{-i \frac{2m\pi}{3}} \end{pmatrix}$$

Easy to resolve spectral projectors $\mathbf{P}^{(m)}$ and eigenvalues ω_m or dispersion functions $\omega(k_m)$

$$\langle m | \mathbf{H} | m \rangle = \langle m | r_0 \mathbf{r}^0 + r_1 \mathbf{r}^1 + r_2 \mathbf{r}^2 | m \rangle = r_0 e^{i m \cdot 0 \frac{2\pi}{3}} + r_1 e^{i m \cdot 1 \frac{2\pi}{3}} + r_2 e^{i m \cdot 2 \frac{2\pi}{3}}$$

m^{th} Eigenvalue of \mathbf{r}^p

$$\langle m | \mathbf{r}^p | m \rangle = e^{i m \cdot p \frac{2\pi}{3}}$$

$$= r_0 e^{i m \cdot 0 \frac{2\pi}{3}} + r(e^{i \frac{2\pi m}{3}} + e^{-i \frac{2\pi m}{3}}) = r_0 + 2r \cos\left(\frac{2\pi m}{3}\right) = \begin{cases} r_0 + 2r & (\text{for } m = 0) \\ r_0 - r & (\text{for } m = \pm 1) \end{cases}$$

H-eigenvalues:

$$\begin{pmatrix} r_0 & r & r \\ r & r_0 & r \\ r & r & r_0 \end{pmatrix} \begin{pmatrix} 1 \\ e^{i \frac{2m\pi}{3}} \\ e^{-i \frac{2m\pi}{3}} \end{pmatrix} = (r_0 + 2r \cos(\frac{2m\pi}{3})) \begin{pmatrix} 1 \\ e^{i \frac{2m\pi}{3}} \\ e^{-i \frac{2m\pi}{3}} \end{pmatrix}$$

K-eigenvalues:

$$\begin{pmatrix} K & -k & -k \\ -k & K & -k \\ -k & -k & K \end{pmatrix} \begin{pmatrix} 1 \\ e^{i \frac{2m\pi}{3}} \\ e^{-i \frac{2m\pi}{3}} \end{pmatrix} = (K - 2k \cos(\frac{2m\pi}{3})) \begin{pmatrix} 1 \\ e^{i \frac{2m\pi}{3}} \\ e^{-i \frac{2m\pi}{3}} \end{pmatrix}$$

Easy to resolve spectral projectors $\mathbf{P}^{(m)}$ and eigenvalues ω_m or dispersion functions $\omega(k_m)$

$$\langle m | \mathbf{H} | m \rangle = \langle m | r_0 \mathbf{r}^0 + r_1 \mathbf{r}^1 + r_2 \mathbf{r}^2 | m \rangle = r_0 e^{i m \cdot 0 \frac{2\pi}{3}} + r_1 e^{i m \cdot 1 \frac{2\pi}{3}} + r_2 e^{i m \cdot 2 \frac{2\pi}{3}}$$

m^{th} Eigenvalue of \mathbf{r}^p

$$\langle m | \mathbf{r}^p | m \rangle = e^{i m \cdot p \frac{2\pi}{3}}$$

$$= r_0 e^{i m \cdot 0 \frac{2\pi}{3}} + r(e^{i \frac{2\pi m}{3}} + e^{-i \frac{2\pi m}{3}}) = r_0 + 2r \cos\left(\frac{2\pi m}{3}\right) = \begin{cases} r_0 + 2r & (\text{for } m = 0) \\ r_0 - r & (\text{for } m = \pm 1) \end{cases}$$

H-eigenvalues:

$$\begin{pmatrix} r_0 & r & r \\ r & r_0 & r \\ r & r & r_0 \end{pmatrix} \begin{pmatrix} 1 \\ e^{i \frac{2m\pi}{3}} \\ e^{-i \frac{2m\pi}{3}} \end{pmatrix} = (r_0 + 2r \cos(\frac{2m\pi}{3})) \begin{pmatrix} 1 \\ e^{i \frac{2m\pi}{3}} \\ e^{-i \frac{2m\pi}{3}} \end{pmatrix}$$

K-eigenvalues:

$$\begin{pmatrix} K & -k & -k \\ -k & K & -k \\ -k & -k & K \end{pmatrix} \begin{pmatrix} 1 \\ e^{i \frac{2m\pi}{3}} \\ e^{-i \frac{2m\pi}{3}} \end{pmatrix} = (K - 2k \cos(\frac{2m\pi}{3})) \begin{pmatrix} 1 \\ e^{i \frac{2m\pi}{3}} \\ e^{-i \frac{2m\pi}{3}} \end{pmatrix}$$

<i>Moving eigenwave</i>	<i>Standing eigenwaves</i>	H – eigenfrequencies	K – eigenfrequencies
$ (+1)_3\rangle = \frac{1}{\sqrt{3}} \begin{pmatrix} 1 \\ e^{+i2\pi/3} \\ e^{-i2\pi/3} \end{pmatrix}$	$ c_3\rangle = \frac{ (+1)_3\rangle + (-1)_3\rangle}{\sqrt{2}} = \frac{1}{\sqrt{6}} \begin{pmatrix} 2 \\ -1 \\ -1 \end{pmatrix}$	$r_0 + 2r \cos(\frac{2m\pi}{3})$ $= r_0 - r$	$\sqrt{k_0 - 2k \cos(\frac{2m\pi}{3})}$ $= \sqrt{k_0 + k}$
$ (-1)_3\rangle = \frac{1}{\sqrt{3}} \begin{pmatrix} 1 \\ e^{-i2\pi/3} \\ e^{+i2\pi/3} \end{pmatrix}$	$ s_3\rangle = \frac{ (+1)_3\rangle - (-1)_3\rangle}{i\sqrt{2}} = \frac{1}{\sqrt{2}} \begin{pmatrix} 0 \\ +1 \\ -1 \end{pmatrix}$	$r_0 + 2r \cos(\frac{-2m\pi}{3})$ $= r_0 - r$	$\sqrt{k_0 - 2k \cos(\frac{2m\pi}{3})}$ $= \sqrt{k_0 + k}$
	$ (\mathbf{0})_3\rangle = \frac{1}{\sqrt{3}} \begin{pmatrix} 1 \\ 1 \\ 1 \end{pmatrix}$	$r_0 + 2r$	$\sqrt{k_0 - 2k}$

Easy to resolve spectral projectors $\mathbf{P}^{(m)}$ and eigenvalues ω_m or dispersion functions $\omega(k_m)$

$$\langle m | \mathbf{H} | m \rangle = \langle m | r_0 \mathbf{r}^0 + r_1 \mathbf{r}^1 + r_2 \mathbf{r}^2 | m \rangle = r_0 e^{i m \cdot 0 \frac{2\pi}{3}} + r_1 e^{i m \cdot 1 \frac{2\pi}{3}} + r_2 e^{i m \cdot 2 \frac{2\pi}{3}}$$

m^{th} Eigenvalue of \mathbf{r}^p

$$\langle m | \mathbf{r}^p | m \rangle = e^{i m \cdot p \frac{2\pi}{3}}$$

$$= r_0 e^{i m \cdot 0 \frac{2\pi}{3}} + r(e^{i \frac{2\pi m}{3}} + e^{-i \frac{2\pi m}{3}}) = r_0 + 2r \cos\left(\frac{2\pi m}{3}\right) = \begin{cases} r_0 + 2r & (\text{for } m = 0) \\ r_0 - r & (\text{for } m = \pm 1) \end{cases}$$

H-eigenvalues:

$$\begin{pmatrix} r_0 & r & r \\ r & r_0 & r \\ r & r & r_0 \end{pmatrix} \begin{pmatrix} 1 \\ e^{i \frac{2m\pi}{3}} \\ e^{-i \frac{2m\pi}{3}} \end{pmatrix} = (r_0 + 2r \cos(\frac{2m\pi}{3})) \begin{pmatrix} 1 \\ e^{i \frac{2m\pi}{3}} \\ e^{-i \frac{2m\pi}{3}} \end{pmatrix}$$

K-eigenvalues:

$$\begin{pmatrix} K & -k & -k \\ -k & K & -k \\ -k & -k & K \end{pmatrix} \begin{pmatrix} 1 \\ e^{i \frac{2m\pi}{3}} \\ e^{-i \frac{2m\pi}{3}} \end{pmatrix} = (K - 2k \cos(\frac{2m\pi}{3})) \begin{pmatrix} 1 \\ e^{i \frac{2m\pi}{3}} \\ e^{-i \frac{2m\pi}{3}} \end{pmatrix}$$

Moving eigenwave	Standing eigenwaves	H - eigenfrequencies	K - eigenfrequencies
$ (+1)_3\rangle = \frac{1}{\sqrt{3}} \begin{pmatrix} 1 \\ e^{+i2\pi/3} \\ e^{-i2\pi/3} \end{pmatrix}$	$ c_3\rangle = \frac{ (+1)_3\rangle + (-1)_3\rangle}{\sqrt{2}} = \frac{1}{\sqrt{6}} \begin{pmatrix} 2 \\ -1 \\ -1 \end{pmatrix}$	$r_0 + 2r \cos(\frac{2m\pi}{3})$ $= r_0 - r$	$\sqrt{k_0 - 2k \cos(\frac{2m\pi}{3})}$ $= \sqrt{k_0 + k}$
$ (-1)_3\rangle = \frac{1}{\sqrt{3}} \begin{pmatrix} 1 \\ e^{-i2\pi/3} \\ e^{+i2\pi/3} \end{pmatrix}$			
	$ s_3\rangle = \frac{ (+1)_3\rangle - (-1)_3\rangle}{i\sqrt{2}} = \frac{1}{\sqrt{2}} \begin{pmatrix} 0 \\ +1 \\ -1 \end{pmatrix}$	$r_0 + 2r \cos(\frac{-2m\pi}{3})$ $= r_0 - r$	$\sqrt{k_0 - 2k \cos(\frac{2m\pi}{3})}$ $= \sqrt{k_0 + k}$
	$ 0_3\rangle = \frac{1}{\sqrt{3}} \begin{pmatrix} 1 \\ 1 \\ 1 \end{pmatrix}$	$r_0 + 2r$	$\sqrt{k_0 - 2k}$

$p=0 \quad p=1 \quad p=2 \quad C_3$ standing wave modes and eigenfrequencies of \mathbf{K}

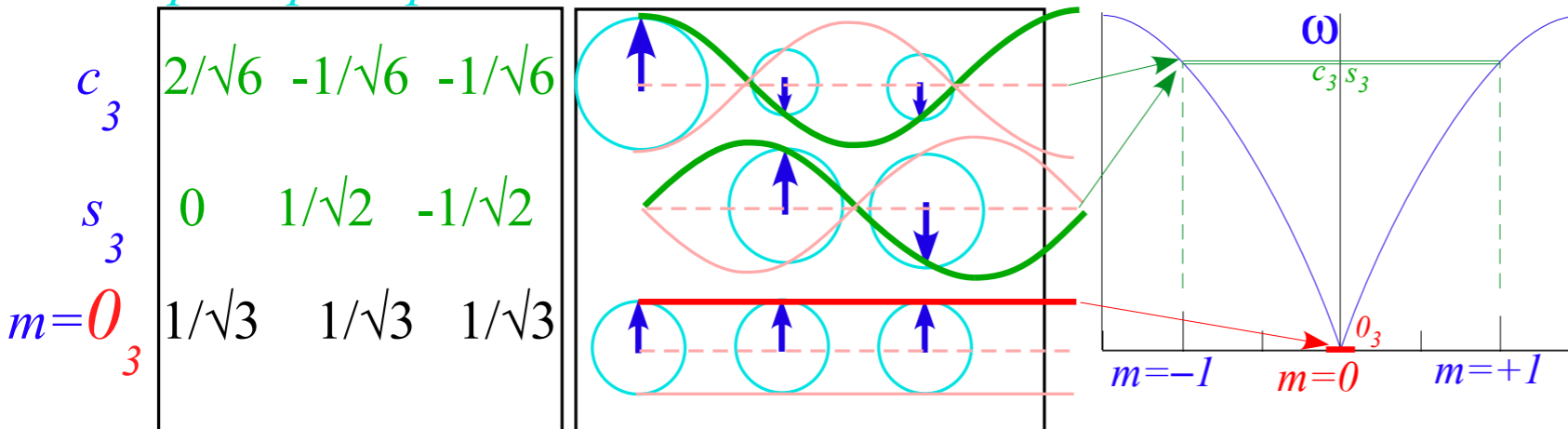

Easy to resolve spectral projectors $\mathbf{P}^{(m)}$ and eigenvalues ω_m or dispersion functions $\omega(k_m)$

$$\langle m | \mathbf{H} | m \rangle = \langle m | r_0 \mathbf{r}^0 + r_1 \mathbf{r}^1 + r_2 \mathbf{r}^2 | m \rangle = r_0 e^{i m \cdot 0 \frac{2\pi}{3}} + r_1 e^{i m \cdot 1 \frac{2\pi}{3}} + r_2 e^{i m \cdot 2 \frac{2\pi}{3}}$$

m^{th} Eigenvalue of \mathbf{r}^p

$$\langle m | \mathbf{r}^p | m \rangle = e^{i m \cdot p \frac{2\pi}{3}}$$

$$= r_0 e^{i m \cdot 0 \frac{2\pi}{3}} + r(e^{i \frac{2\pi m}{3}} + e^{-i \frac{2\pi m}{3}}) = r_0 + 2r \cos\left(\frac{2\pi m}{3}\right) = \begin{cases} r_0 + 2r & (\text{for } m = 0) \\ r_0 - r & (\text{for } m = \pm 1) \end{cases}$$

H-eigenvalues:

$$\begin{pmatrix} r_0 & r & r \\ r & r_0 & r \\ r & r & r_0 \end{pmatrix} \begin{pmatrix} 1 \\ e^{i \frac{2m\pi}{3}} \\ e^{-i \frac{2m\pi}{3}} \end{pmatrix} = (r_0 + 2r \cos(\frac{2m\pi}{3})) \begin{pmatrix} 1 \\ e^{i \frac{2m\pi}{3}} \\ e^{-i \frac{2m\pi}{3}} \end{pmatrix}$$

K-eigenvalues:

$$\begin{pmatrix} K & -k & -k \\ -k & K & -k \\ -k & -k & K \end{pmatrix} \begin{pmatrix} 1 \\ e^{i \frac{2m\pi}{3}} \\ e^{-i \frac{2m\pi}{3}} \end{pmatrix} = (K - 2k \cos(\frac{2m\pi}{3})) \begin{pmatrix} 1 \\ e^{i \frac{2m\pi}{3}} \\ e^{-i \frac{2m\pi}{3}} \end{pmatrix}$$

Moving eigenwave	Standing eigenwaves	H - eigenfrequencies	K - eigenfrequencies
$ (+1)_3\rangle = \frac{1}{\sqrt{3}} \begin{pmatrix} 1 \\ e^{+i2\pi/3} \\ e^{-i2\pi/3} \end{pmatrix}$	$ c_3\rangle = \frac{ (+1)_3\rangle + (-1)_3\rangle}{\sqrt{2}} = \frac{1}{\sqrt{6}} \begin{pmatrix} 2 \\ -1 \\ -1 \end{pmatrix}$	$r_0 + 2r \cos(\frac{2m\pi}{3})$ $= r_0 - r$	$\sqrt{k_0 - 2k \cos(\frac{2m\pi}{3})}$ $= \sqrt{k_0 + k}$
$ (-1)_3\rangle = \frac{1}{\sqrt{3}} \begin{pmatrix} 1 \\ e^{-i2\pi/3} \\ e^{+i2\pi/3} \end{pmatrix}$			
	$ s_3\rangle = \frac{ (+1)_3\rangle - (-1)_3\rangle}{i\sqrt{2}} = \frac{1}{\sqrt{2}} \begin{pmatrix} 0 \\ +1 \\ -1 \end{pmatrix}$	$r_0 + 2r \cos(\frac{-2m\pi}{3})$ $= r_0 - r$	$\sqrt{k_0 - 2k \cos(\frac{2m\pi}{3})}$ $= \sqrt{k_0 + k}$
	$ o_3\rangle = \frac{1}{\sqrt{3}} \begin{pmatrix} 1 \\ 1 \\ 1 \end{pmatrix}$	$r_0 + 2r$	$\sqrt{k_0 - 2k}$

Transverse (to k) Waves

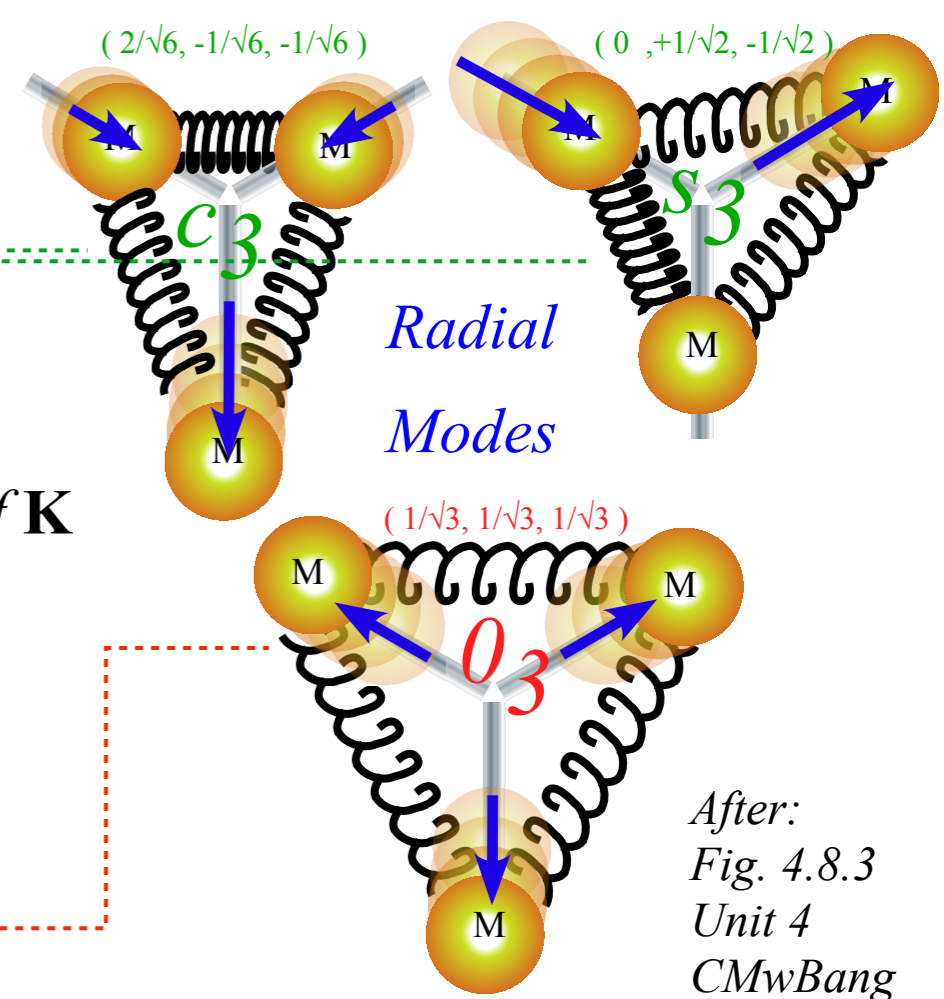

C_3 standing wave modes and eigenfrequencies of **K**

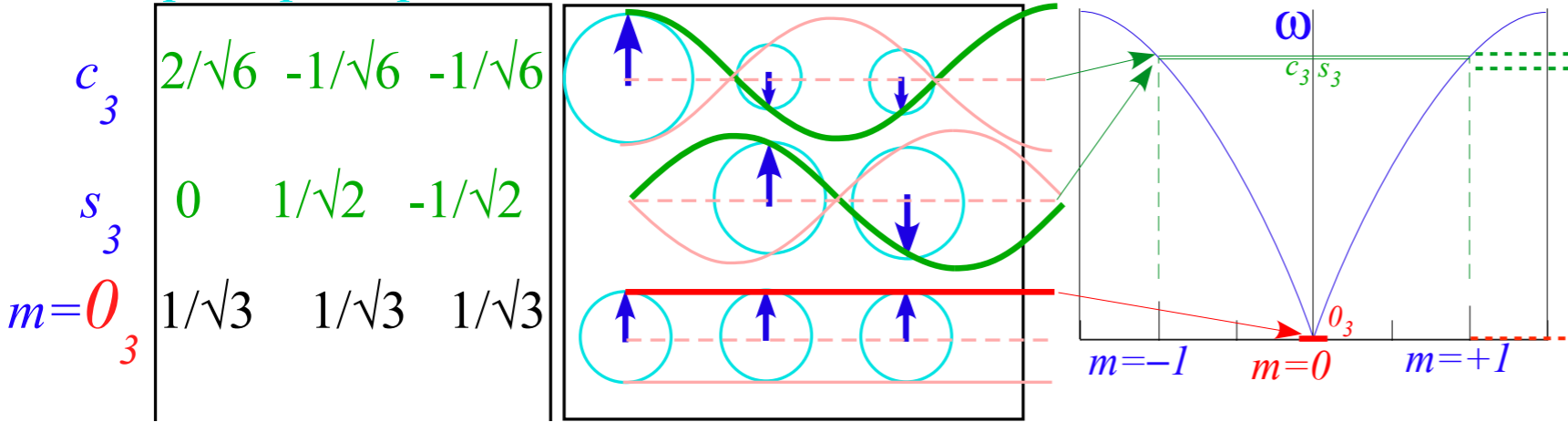

After:
Fig. 4.8.3
Unit 4
CMwBang

Easy to resolve spectral projectors $\mathbf{P}^{(m)}$ and eigenvalues ω_m or dispersion functions $\omega(k_m)$

$$\langle m | \mathbf{H} | m \rangle = \langle m | r_0 \mathbf{r}^0 + r_1 \mathbf{r}^1 + r_2 \mathbf{r}^2 | m \rangle = r_0 e^{i m \cdot 0 \frac{2\pi}{3}} + r_1 e^{i m \cdot 1 \frac{2\pi}{3}} + r_2 e^{i m \cdot 2 \frac{2\pi}{3}}$$

m^{th} Eigenvalue of \mathbf{r}^p

$$\langle m | \mathbf{r}^p | m \rangle = e^{i m \cdot p \frac{2\pi}{3}}$$

$$= r_0 e^{i m \cdot 0 \frac{2\pi}{3}} + r(e^{i \frac{2\pi m}{3}} + e^{-i \frac{2\pi m}{3}}) = r_0 + 2r \cos\left(\frac{2\pi m}{3}\right) = \begin{cases} r_0 + 2r & (\text{for } m = 0) \\ r_0 - r & (\text{for } m = \pm 1) \end{cases}$$

H-eigenvalues:

$$\begin{pmatrix} r_0 & r & r \\ r & r_0 & r \\ r & r & r_0 \end{pmatrix} \begin{pmatrix} 1 \\ e^{i \frac{2m\pi}{3}} \\ e^{-i \frac{2m\pi}{3}} \end{pmatrix} = (r_0 + 2r \cos(\frac{2m\pi}{3})) \begin{pmatrix} 1 \\ e^{i \frac{2m\pi}{3}} \\ e^{-i \frac{2m\pi}{3}} \end{pmatrix}$$

K-eigenvalues:

$$\begin{pmatrix} K & -k & -k \\ -k & K & -k \\ -k & -k & K \end{pmatrix} \begin{pmatrix} 1 \\ e^{i \frac{2m\pi}{3}} \\ e^{-i \frac{2m\pi}{3}} \end{pmatrix} = (K - 2k \cos(\frac{2m\pi}{3})) \begin{pmatrix} 1 \\ e^{i \frac{2m\pi}{3}} \\ e^{-i \frac{2m\pi}{3}} \end{pmatrix}$$

Moving eigenwave	Standing eigenwaves	H - eigenfrequencies	K - eigenfrequencies
$ (+1)_3\rangle = \frac{1}{\sqrt{3}} \begin{pmatrix} 1 \\ e^{+i2\pi/3} \\ e^{-i2\pi/3} \end{pmatrix}$	$ c_3\rangle = \frac{ (+1)_3\rangle + (-1)_3\rangle}{\sqrt{2}} = \frac{1}{\sqrt{6}} \begin{pmatrix} 2 \\ -1 \\ -1 \end{pmatrix}$	$r_0 + 2r \cos(\frac{2m\pi}{3})$ $= r_0 - r$	$\sqrt{k_0 - 2k \cos(\frac{2m\pi}{3})}$ $= \sqrt{k_0 + k}$
$ (-1)_3\rangle = \frac{1}{\sqrt{3}} \begin{pmatrix} 1 \\ e^{-i2\pi/3} \\ e^{+i2\pi/3} \end{pmatrix}$	$ s_3\rangle = \frac{ (+1)_3\rangle - (-1)_3\rangle}{i\sqrt{2}} = \frac{1}{\sqrt{2}} \begin{pmatrix} 0 \\ +1 \\ -1 \end{pmatrix}$	$r_0 + 2r \cos(\frac{-2m\pi}{3})$ $= r_0 - r$	$\sqrt{k_0 - 2k \cos(\frac{2m\pi}{3})}$ $= \sqrt{k_0 + k}$
	$ 0_3\rangle = \frac{1}{\sqrt{3}} \begin{pmatrix} 1 \\ 1 \\ 1 \end{pmatrix}$	$r_0 + 2r$	$\sqrt{k_0 - 2k}$

Longitudinal (to k) Waves

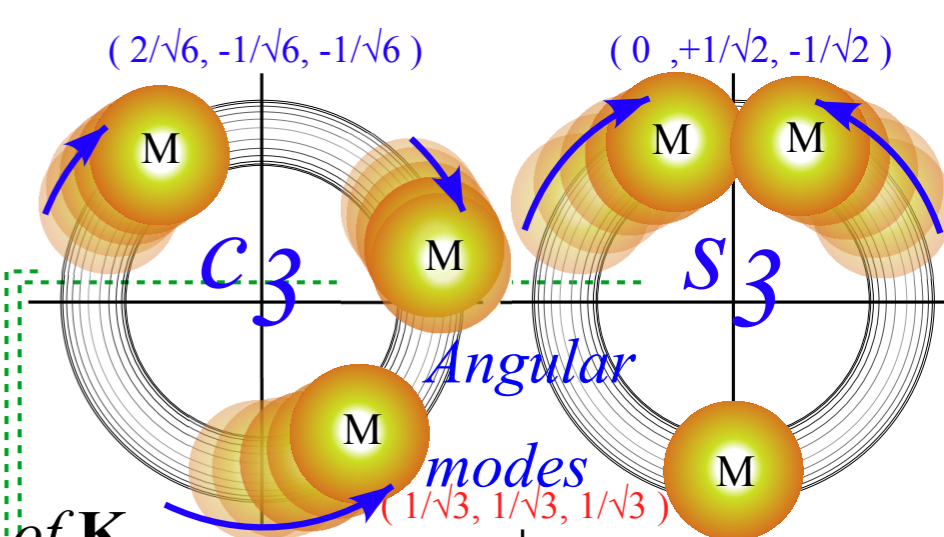

C_3 standing wave modes and eigenfrequencies of \mathbf{K}

	$p=0$	$p=1$	$p=2$
c_3	$2/\sqrt{6}$	$-1/\sqrt{6}$	$-1/\sqrt{6}$
s_3	0	$1/\sqrt{2}$	$-1/\sqrt{2}$
$m=0_3$	$1/\sqrt{3}$	$1/\sqrt{3}$	$1/\sqrt{3}$

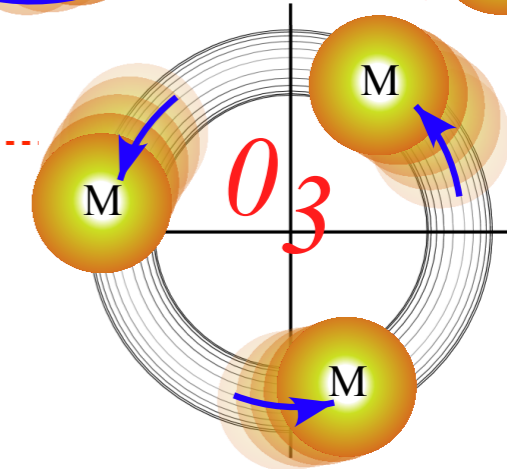
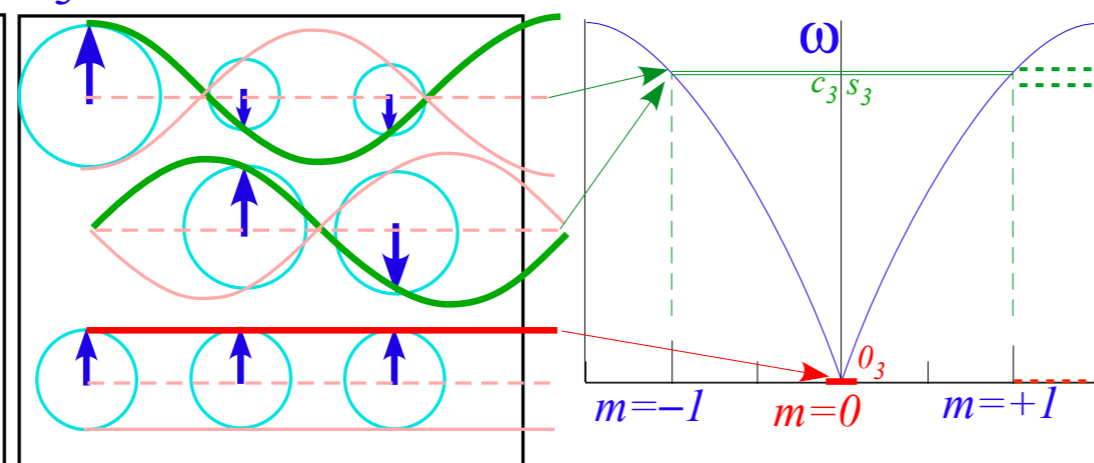

Wave resonance in cyclic symmetry

Harmonic oscillator with cyclic C_2 symmetry

C_2 symmetric (B-type) modes

Harmonic oscillator with cyclic C_3 symmetry

C_3 symmetric spectral decomposition by 3rd roots of unity

Resolving C_3 projectors and moving wave modes

Dispersion functions and standing waves

➔ *C_6 symmetric mode model: Distant neighbor coupling*

C_6 spectra of gauge splitting by C-type symmetry (complex, chiral, coriolis, current, ..)

C_N symmetric mode models: Made-to order dispersion functions

Quadratic dispersion models: Super-beats and fractional revivals

Phase arithmetic

C₆ Symmetric Mode Model: Distant neighbor coupling

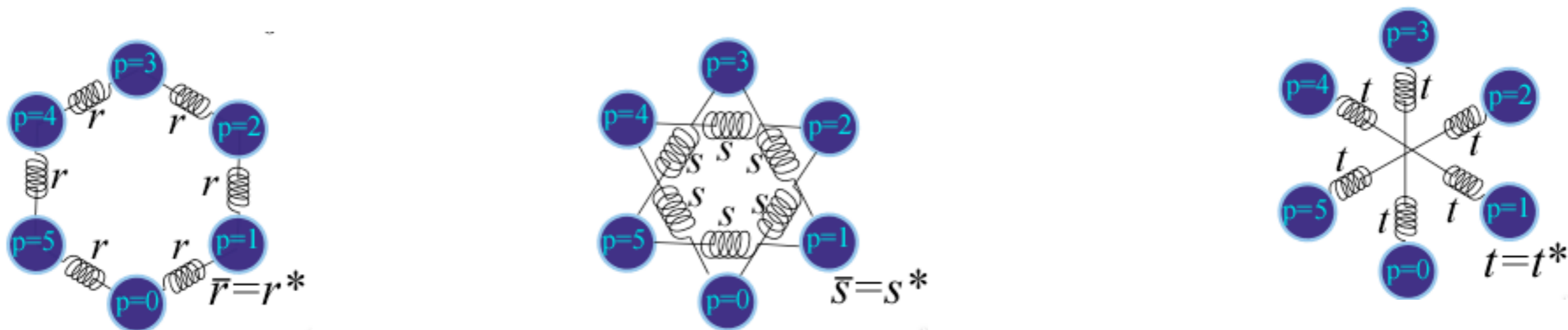
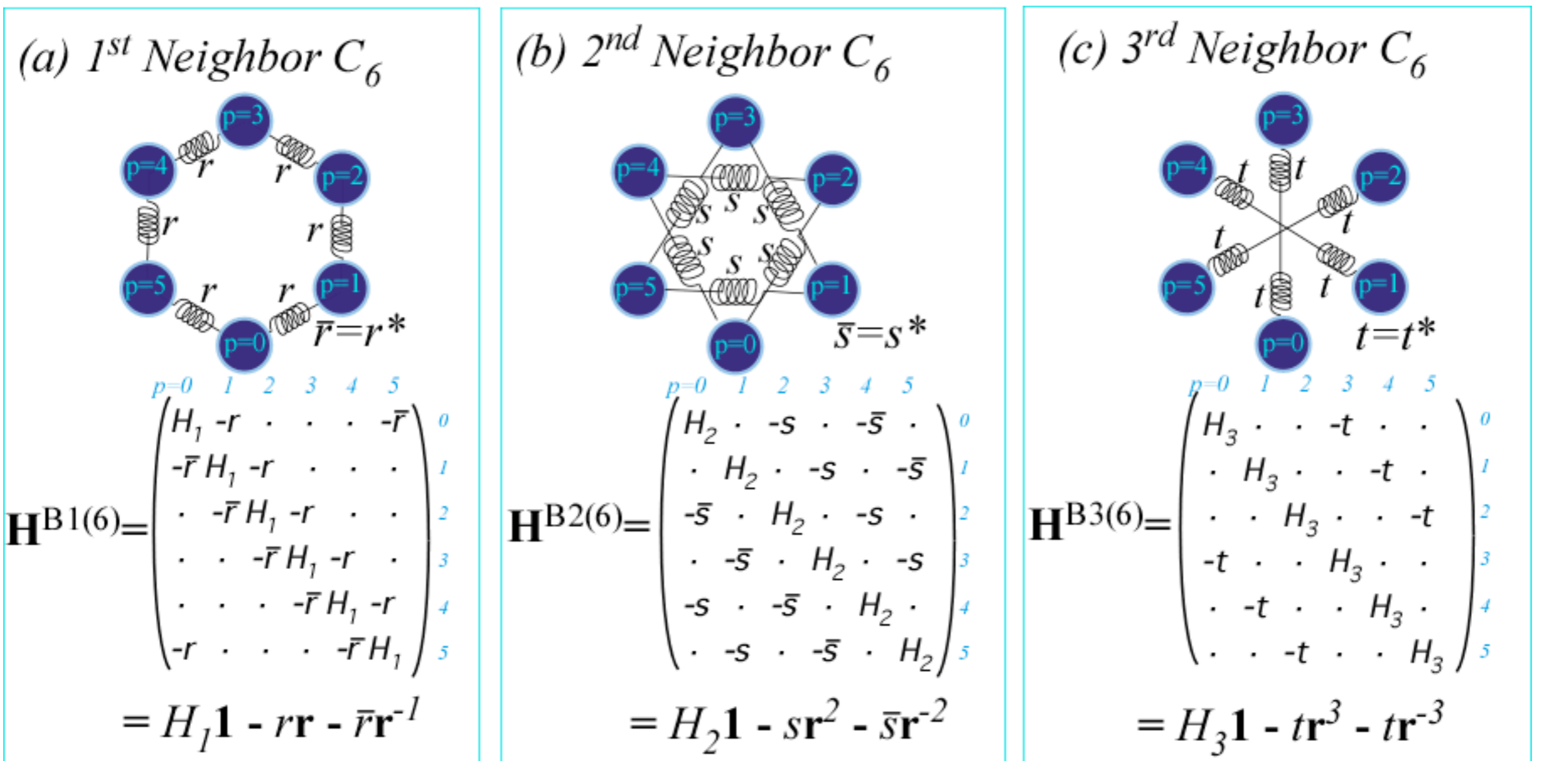
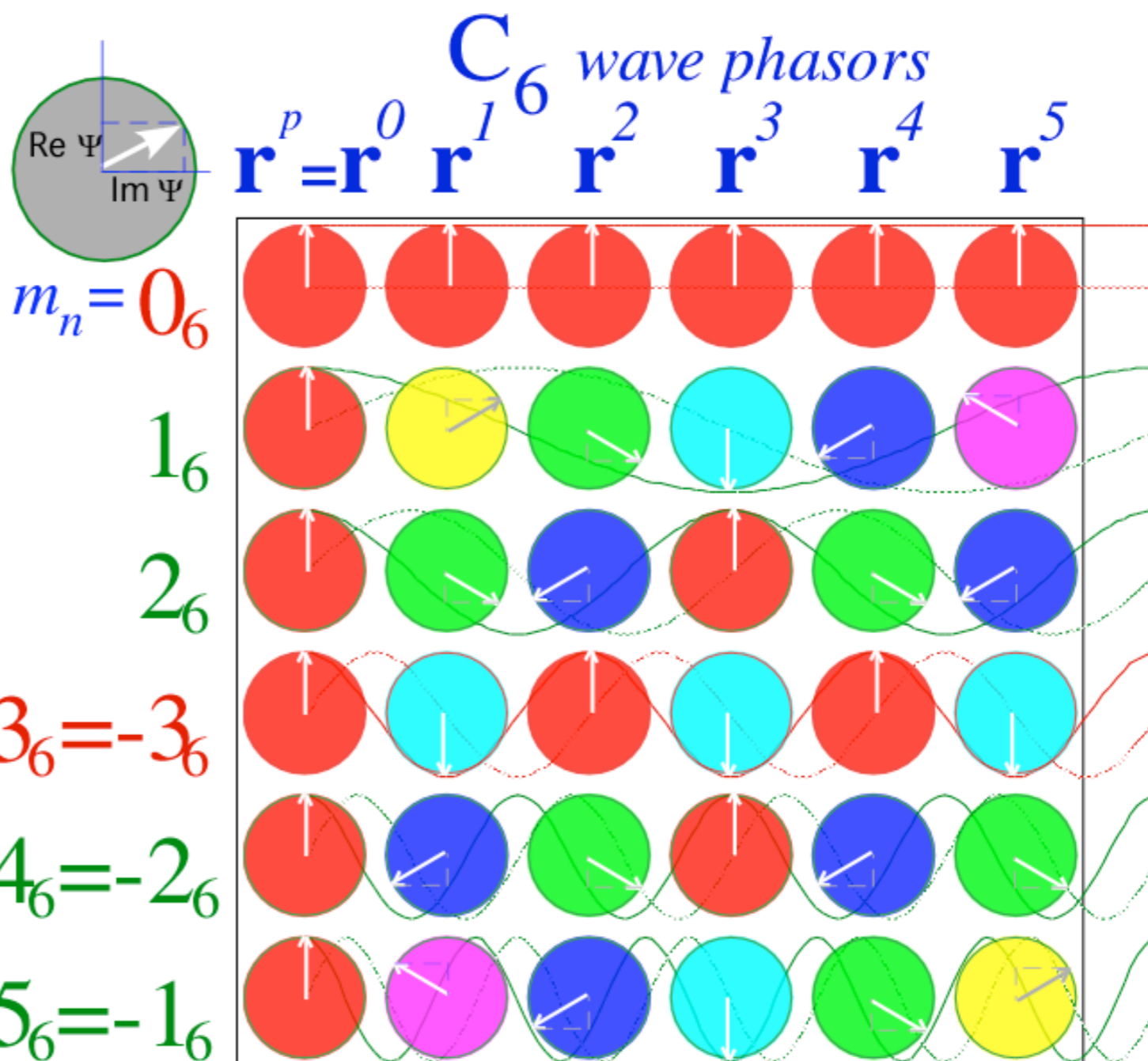

Fig. 12 International Journal of Molecular Science 14, 749 (2013)

C₆ Spectral resolution: 6th roots of unity

$\chi_p^{m*}(C_6)$	$r^{p=0}$	r^1	r^2	r^3	r^4	r^5
$m=0_6$	1	1	1	1	1	1
1_6	1	ϵ^*	ϵ^{2*}	-1	ϵ^2	ϵ
2_6	1	ϵ^{2*}	ϵ^2	1	ϵ^{2*}	ϵ^2
$3_6 = -3_6$	1	-1	1	-1	1	-1
$4_6 = -2_6$	1	ϵ^2	ϵ^{2*}	1	ϵ^2	ϵ^{2*}
$5_6 = -1_6$	1	ϵ	ϵ^2	-1	ϵ^{2*}	ϵ^*

Wavefunction: $\Psi^m(x_p) = \chi_p^{m*} = D^{m*}(r^p)$



$$\chi_p^m = e^{ik_m r^p} = e^{\frac{2\pi i m p}{6}}$$

Fig. 13 International Journal of Molecular Science 14, 752 (2013)

C₆ Spectral resolution of nth Neighbor H: Same modes but different dispersion

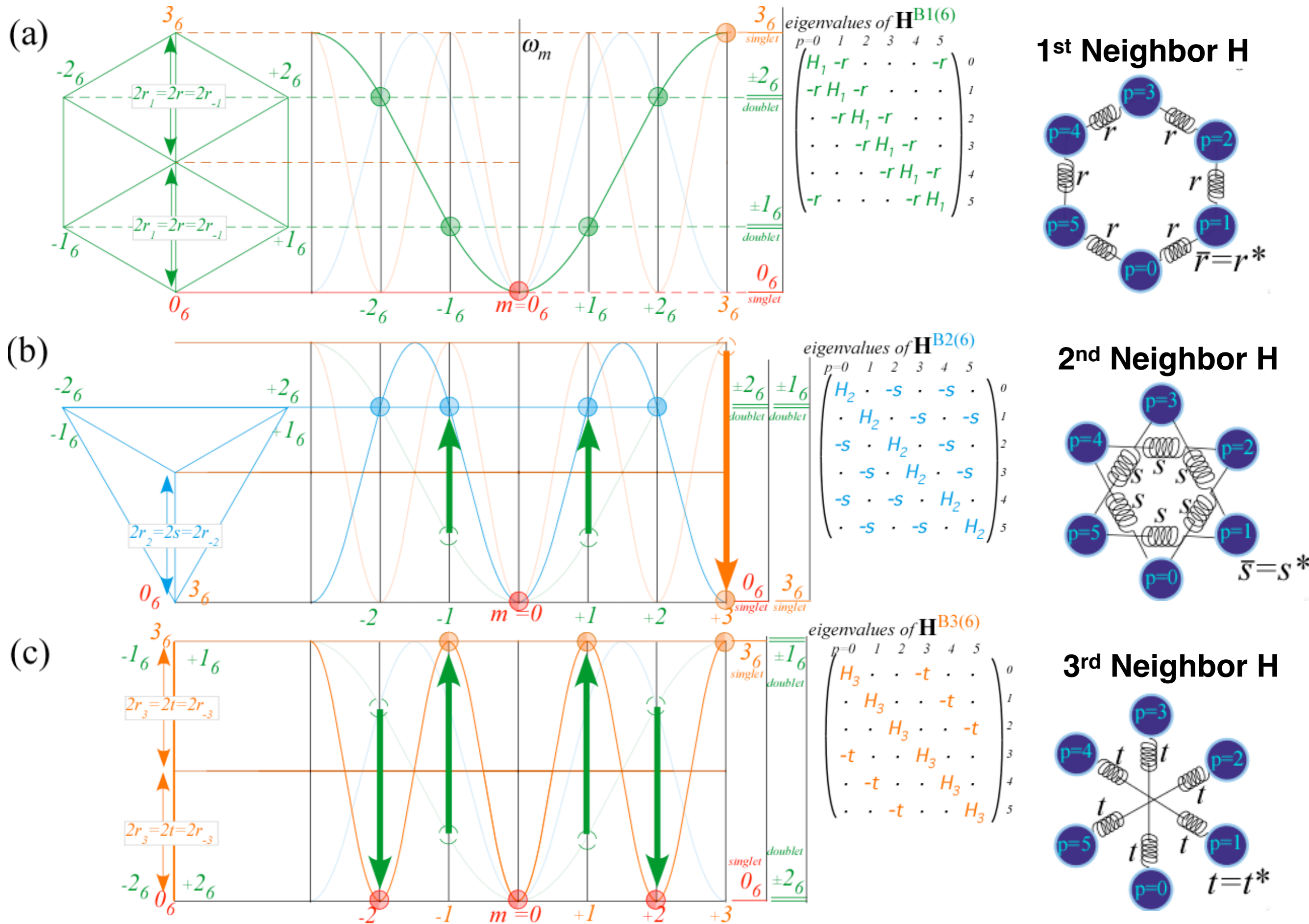

Fig. 14 International Journal of Molecular Science 14, 754 (2013)

Wave resonance in cyclic symmetry

Harmonic oscillator with cyclic C_2 symmetry

C_2 symmetric (B-type) modes

Harmonic oscillator with cyclic C_3 symmetry

C_3 symmetric spectral decomposition by 3rd roots of unity

Resolving C_3 projectors and moving wave modes

Dispersion functions and standing waves

C_6 symmetric mode model: Distant neighbor coupling



C_6 spectra of gauge splitting by C-type symmetry (complex, chiral, coriolis, current, ..)

C_N symmetric mode models: Made-to order dispersion functions

Quadratic dispersion models: Super-beats and fractional revivals

Phase arithmetic

C₆ Spectra of 1st neighbor gauge splitting by C-type (Chiral, Coriolis,...,

1st Neighbor H

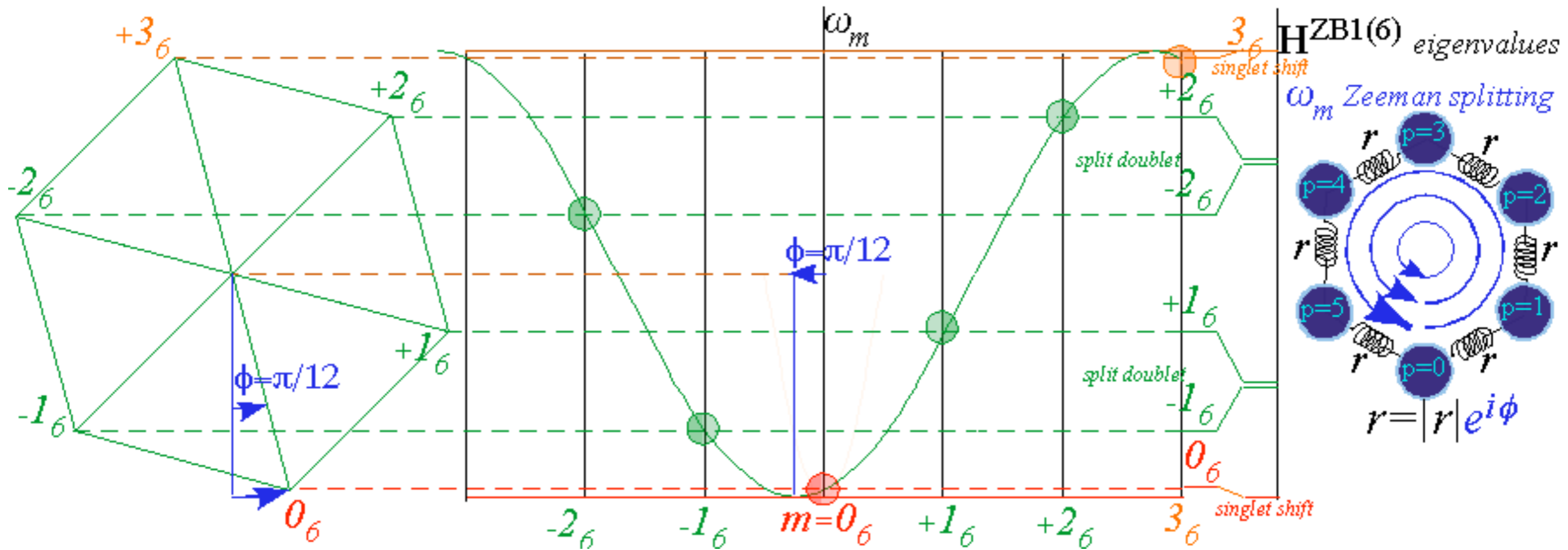
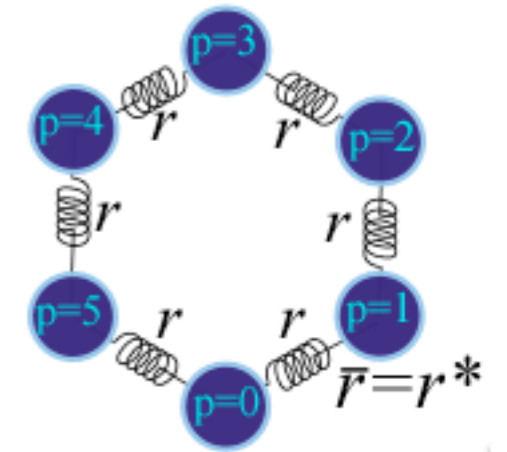

Fig. 15 International Journal of Molecular Science 14, 755 (2013)

Wave resonance in cyclic symmetry

Harmonic oscillator with cyclic C_2 symmetry

C_2 symmetric (B-type) modes

Harmonic oscillator with cyclic C_3 symmetry

C_3 symmetric spectral decomposition by 3rd roots of unity

Resolving C_3 projectors and moving wave modes

Dispersion functions and standing waves

C_6 symmetric mode model: Distant neighbor coupling

C_6 spectra of gauge splitting by C-type symmetry (complex, chiral, coriolis, current, ..)

➔ *C_N symmetric mode models: Made-to order dispersion functions*

Quadratic dispersion models: Super-beats and fractional revivals

Phase arithmetic

C_N Symmetric Mode Models:

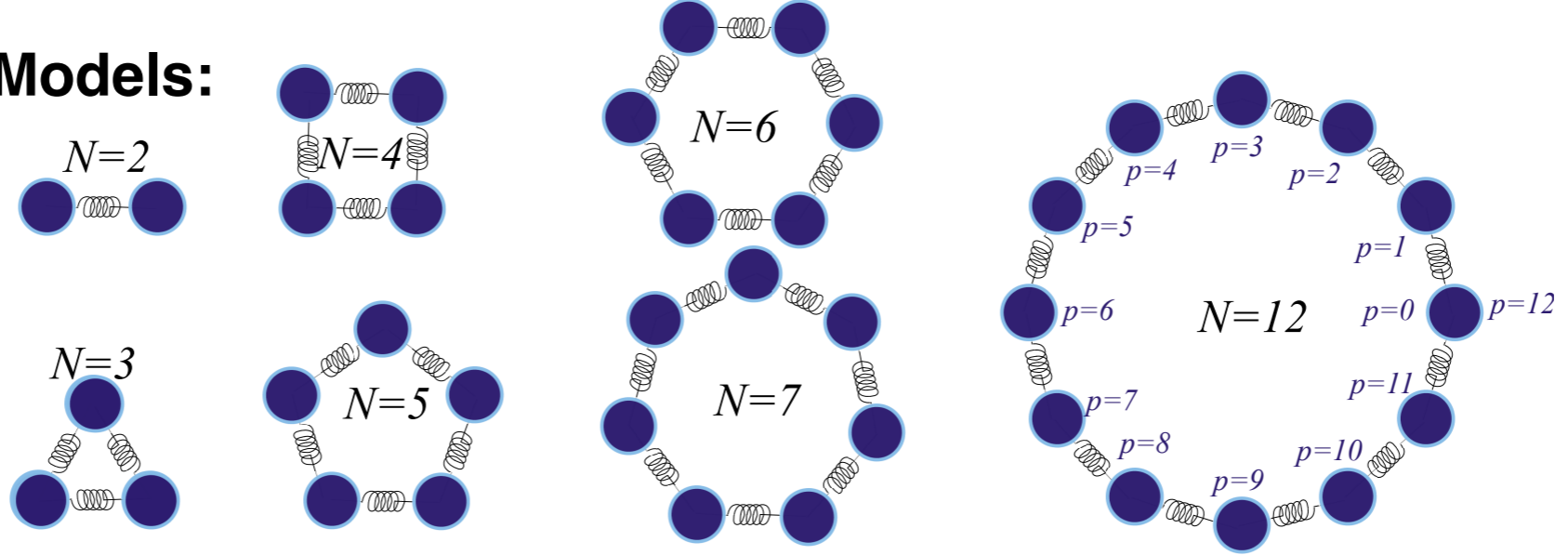

Fig. 4.8.4
Unit 4
CMwBang

C_N Symmetric Mode Models:

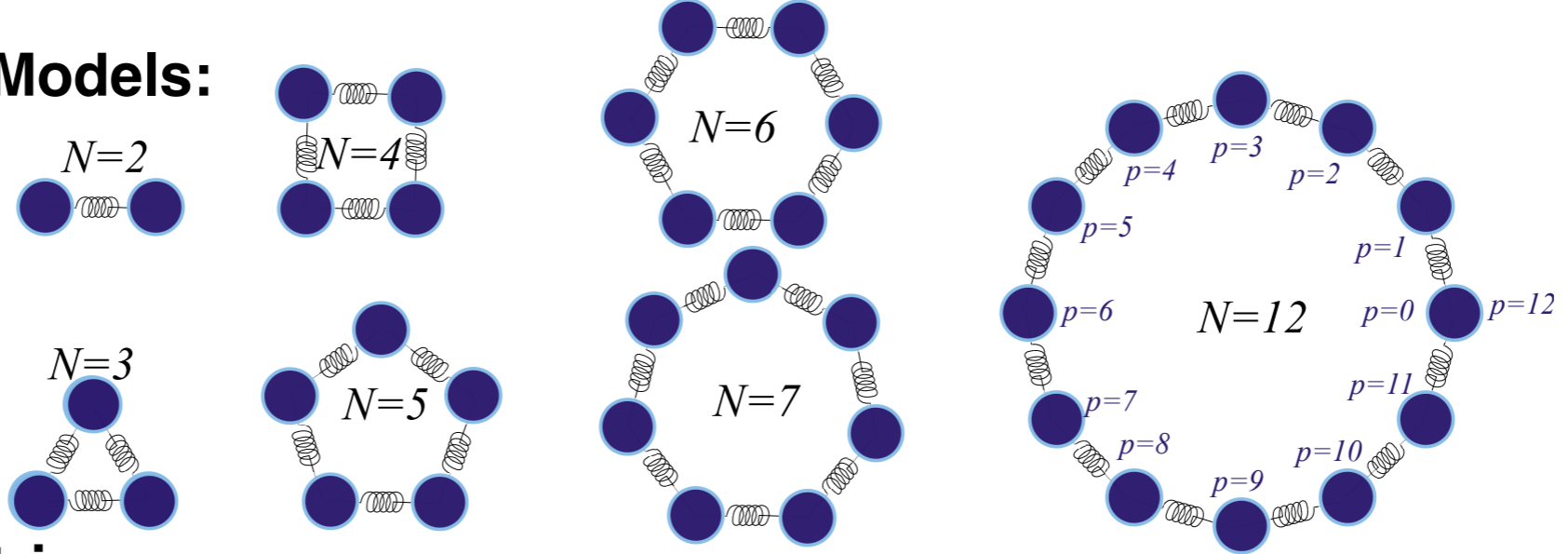

Fig. 4.8.4
Unit 4
CMwBang

1st Neighbor K-matrix

$$\begin{pmatrix} F_0 \\ F_1 \\ F_2 \\ F_3 \\ F_4 \\ \vdots \\ F_{N-1} \end{pmatrix} = \begin{pmatrix} K & -k_{12} & \cdot & \cdot & \cdot & \cdots & -k_{12} \\ -k_{12} & K & -k_{12} & \cdot & \cdot & \cdots & \cdot \\ \cdot & -k_{12} & K & -k_{12} & \cdot & \cdots & \cdot \\ \cdot & \cdot & -k_{12} & K & -k_{12} & \cdots & \cdot \\ \cdot & \cdot & \cdot & -k_{12} & K & \cdots & \cdot \\ \vdots & \vdots & \vdots & \vdots & \vdots & \ddots & -k_{12} \\ -k_{12} & \cdot & \cdot & \cdot & \cdot & -k_{12} & K \end{pmatrix} \bullet \begin{pmatrix} x_0 \\ x_1 \\ x_2 \\ x_3 \\ x_4 \\ \vdots \\ x_{N-1} \end{pmatrix} \quad \text{where:} \quad \begin{aligned} K &= k + 2k_{12} \\ k &= \frac{Mg}{\ell} \\ (\cdot) &= 0 \end{aligned}$$

C_N Symmetric Mode Models:

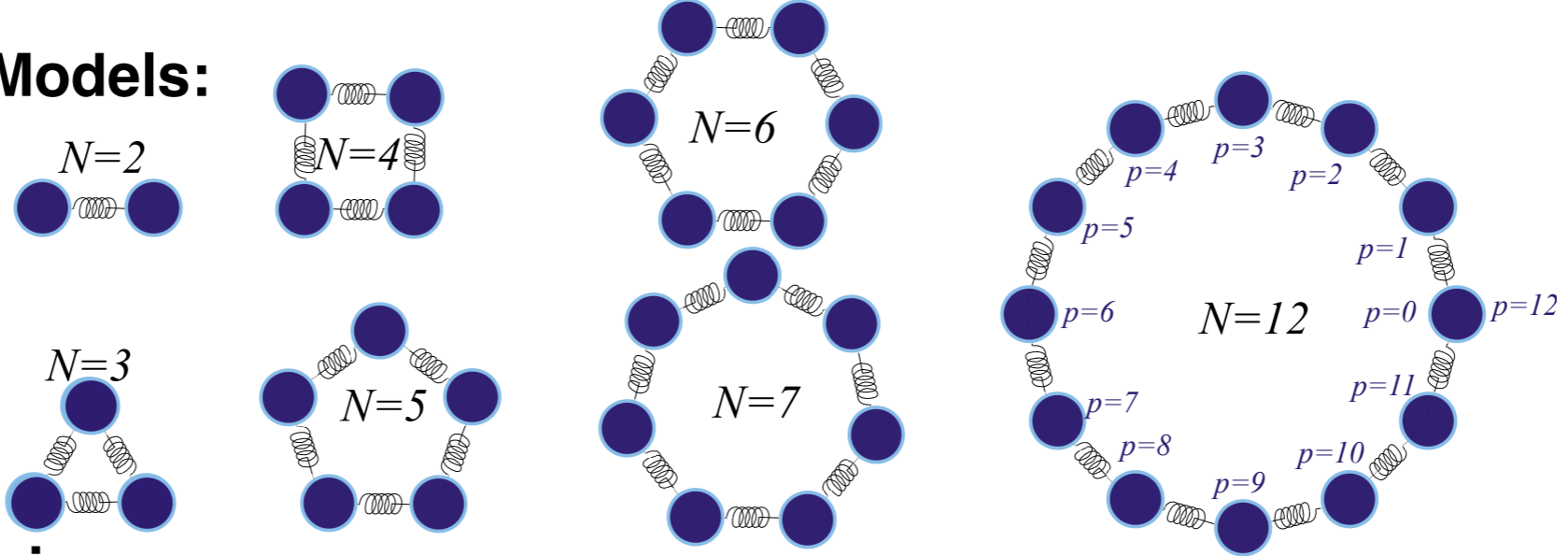

Fig. 4.8.4
Unit 4
CMwBang

1st Neighbor K-matrix

$$\begin{pmatrix} F_0 \\ F_1 \\ F_2 \\ F_3 \\ F_4 \\ \vdots \\ F_{N-1} \end{pmatrix} = \begin{pmatrix} K & -k_{12} & \cdot & \cdot & \cdot & \cdots & -k_{12} \\ -k_{12} & K & -k_{12} & \cdot & \cdot & \cdots & \cdot \\ \cdot & -k_{12} & K & -k_{12} & \cdot & \cdots & \cdot \\ \cdot & \cdot & -k_{12} & K & -k_{12} & \cdots & \cdot \\ \cdot & \cdot & \cdot & -k_{12} & K & \cdots & \cdot \\ \vdots & \vdots & \vdots & \vdots & \vdots & \ddots & -k_{12} \\ -k_{12} & \cdot & \cdot & \cdot & \cdot & -k_{12} & K \end{pmatrix} \cdot \begin{pmatrix} x_0 \\ x_1 \\ x_2 \\ x_3 \\ x_4 \\ \vdots \\ x_{N-1} \end{pmatrix}$$

where: $K = k + 2k_{12}$
 $k = \frac{Mg}{\ell}$
 $(\cdot) = 0$

Nth roots of 1 $e^{i m \cdot p 2\pi/N} = \langle m | \mathbf{r}^p | m \rangle$ serving as *e-values, eigenfunctions, transformation matrices, dispersion relations, Group reps. etc.*

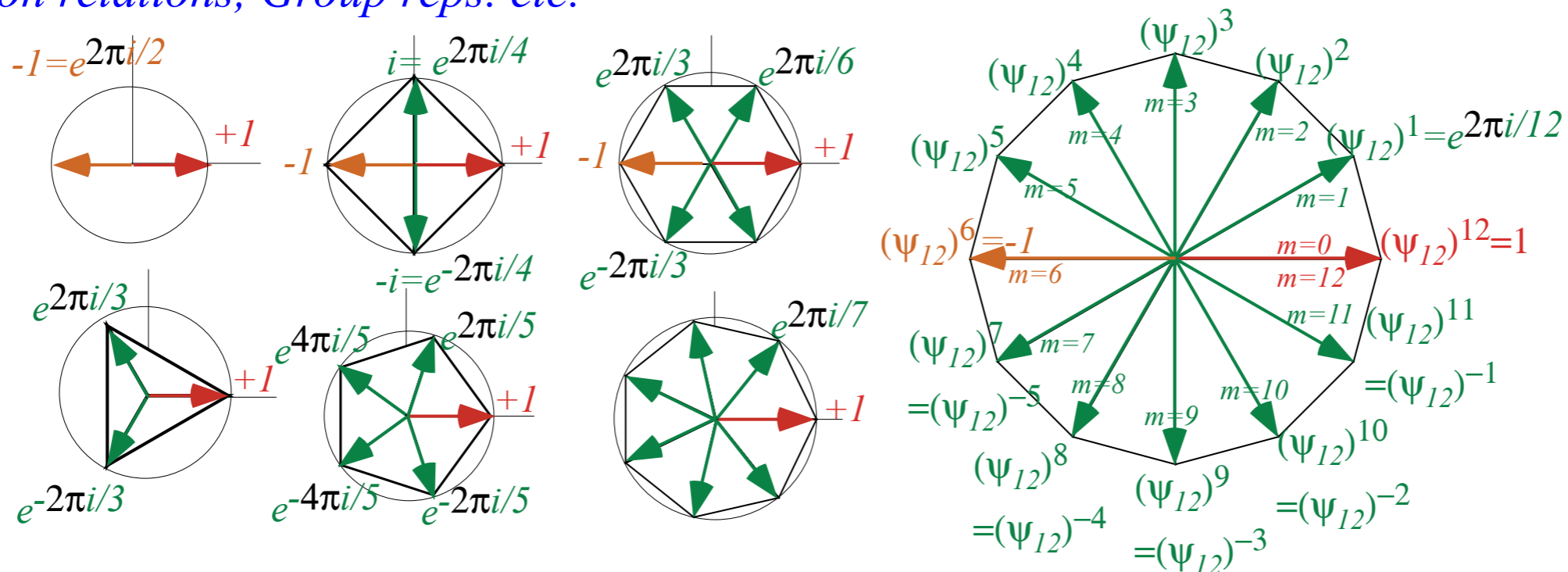
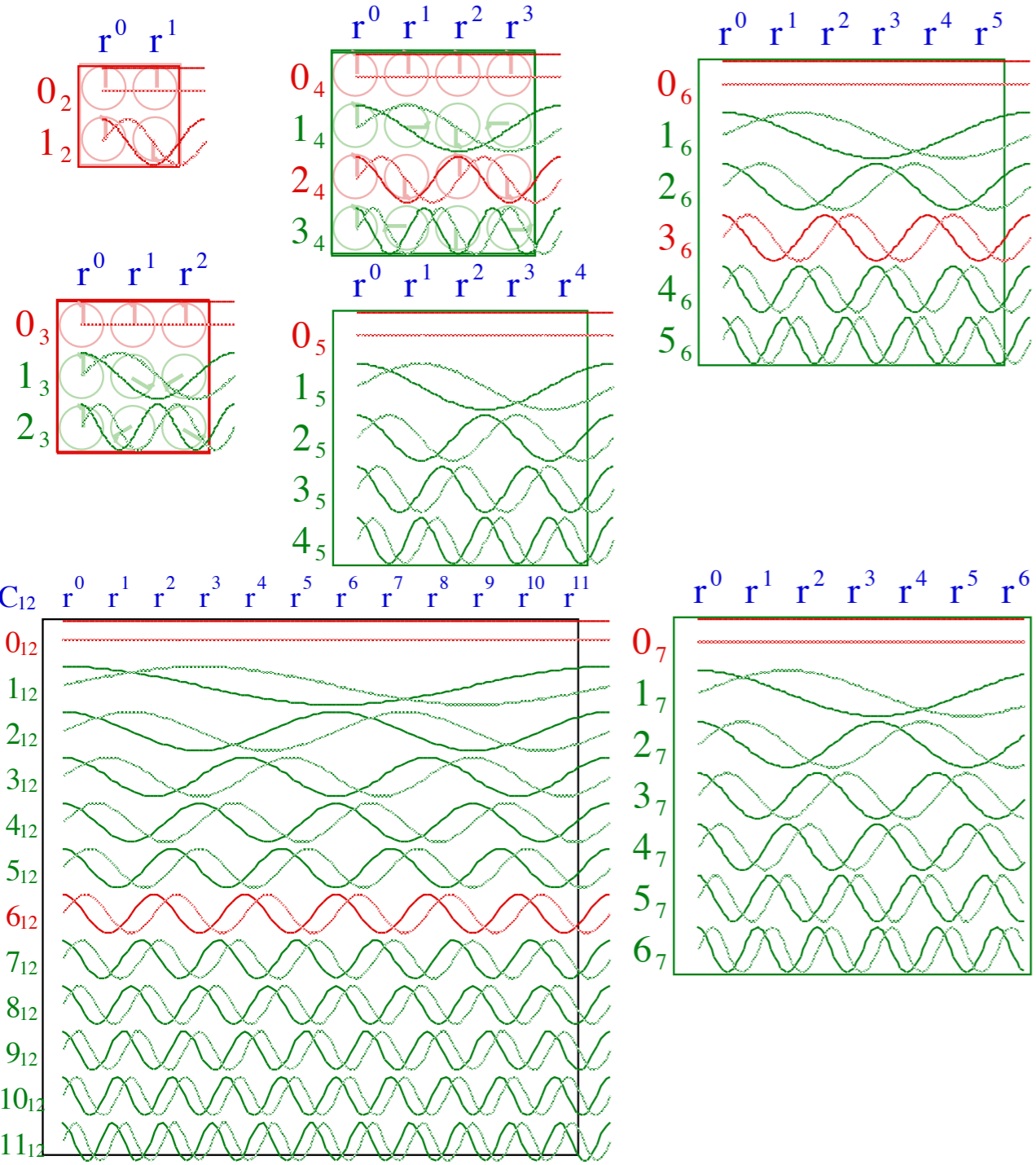

Fig. 4.8.5
Unit 4
CMwBang

C_N Symmetric Mode Models:

Nth roots of 1 $e^{i m \cdot p 2\pi/N} = \langle m | \mathbf{r}^p | m \rangle$ serving as *e-values*, *eigenfunctions*, *transformation matrices*, *dispersion relations*, *Group reps.* etc.



WaveIt C₁₂ Web Simulation

Fig. 4.8.6-7
Unit 4
CMwBang

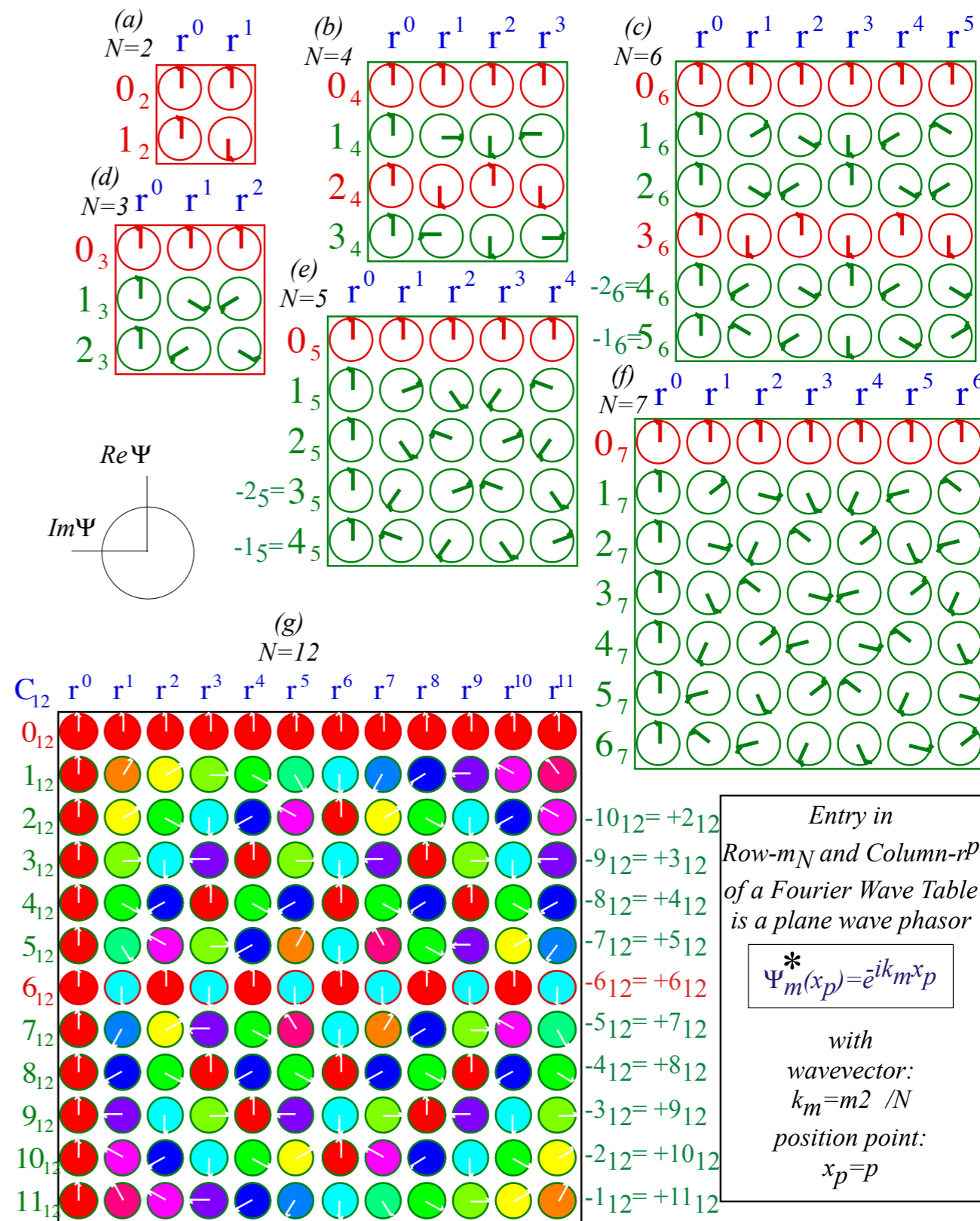

WaveIt C₁₂ Character Phasors Web Simulation

Fourier
transformation matrices

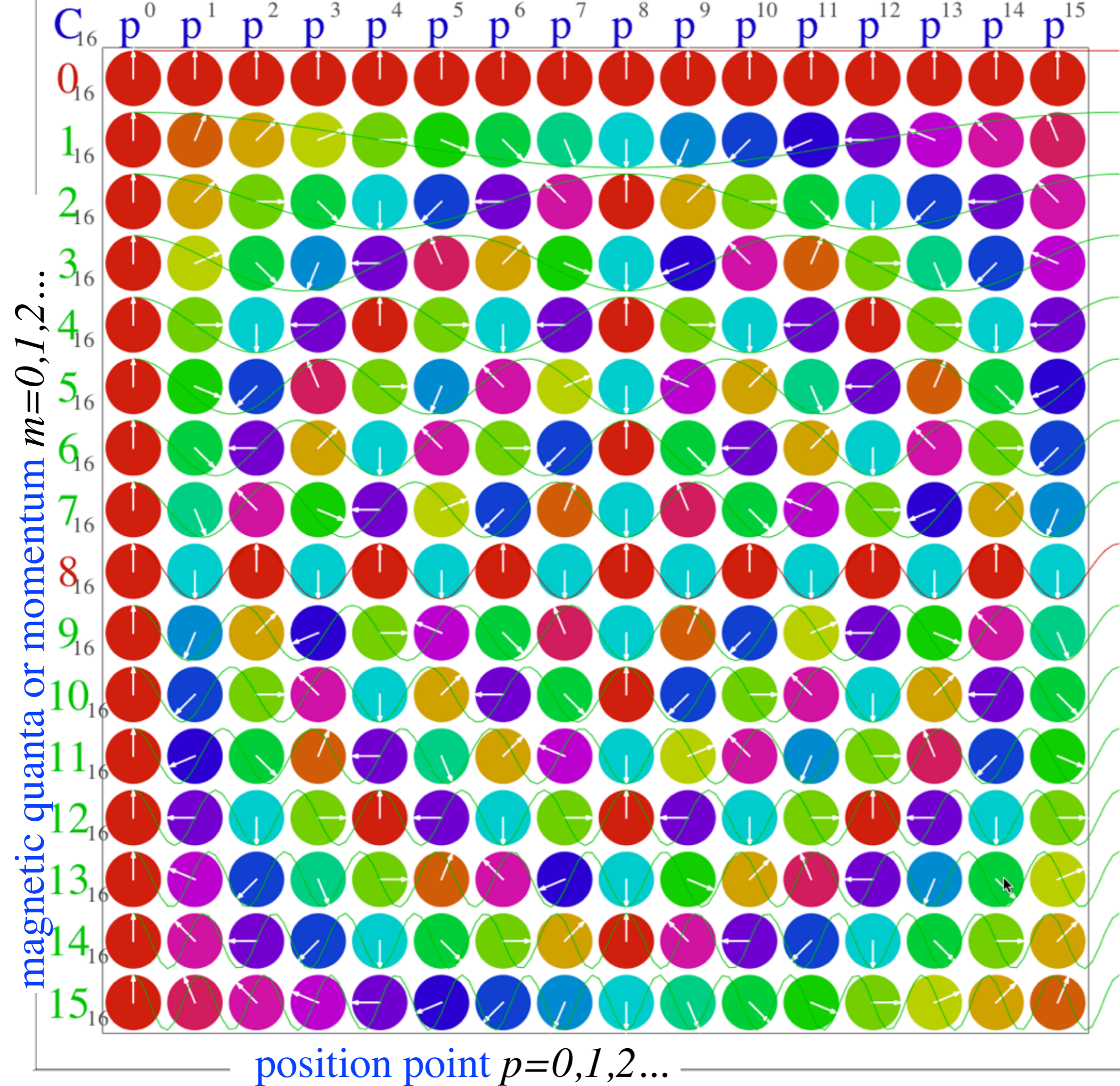

C_{16}

phasor
character
table

$$\chi_p^m = e^{ik_m r^p}$$

$$= e^{\frac{2\pi i m p}{16}}$$

[WaveIt C₁₆ Character Phasors Web Simulation](#)

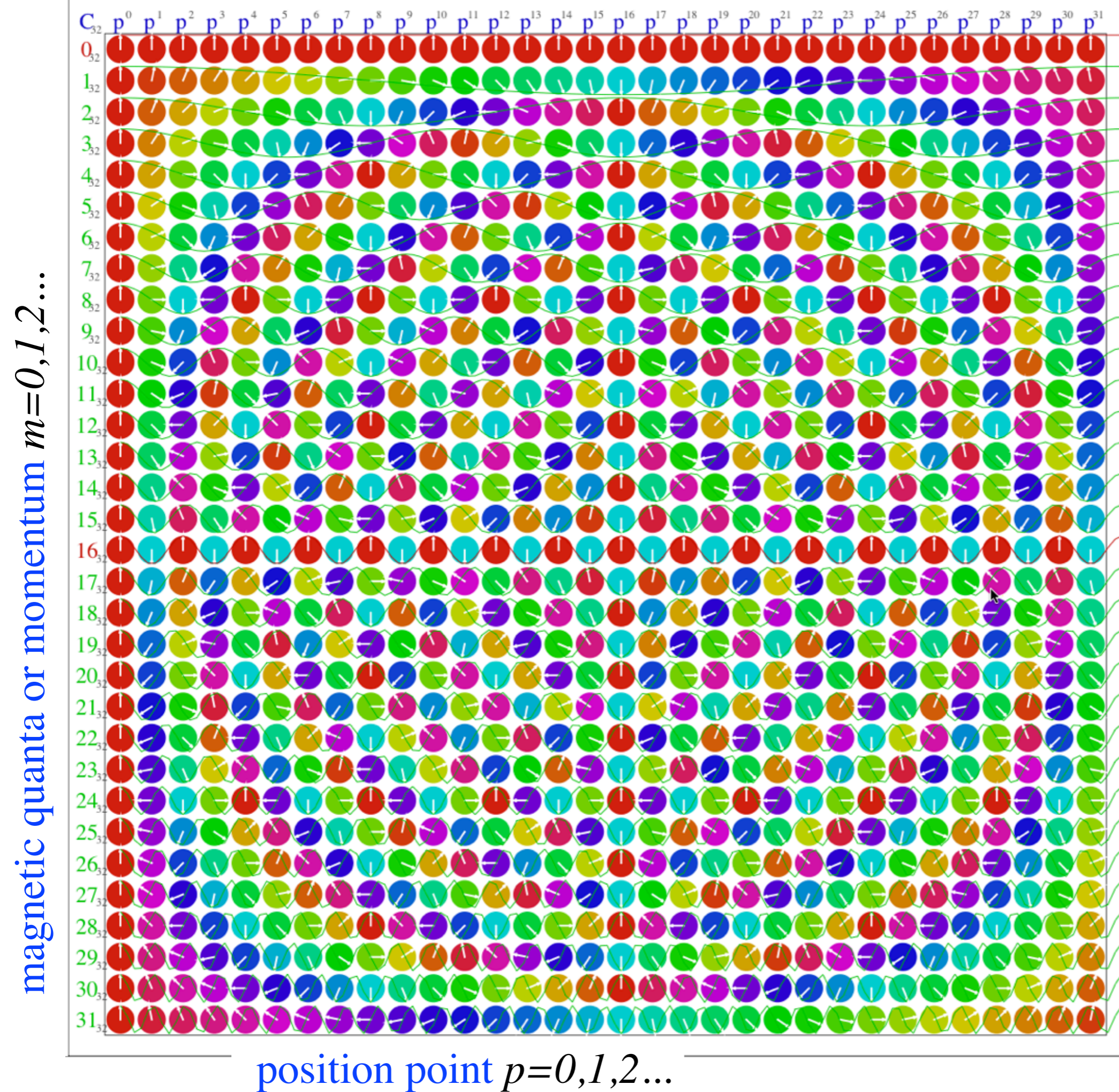

C_{32}

phasor
character
table

$$\chi_p^m = e^{ik_m r^p}$$

$$= e^{\frac{2\pi i m p}{32}}$$

[WaveIt C₃₂ Character Phasors Web Simulation](#)

magnetic quanta or momentum $m=0,1,2,\dots$

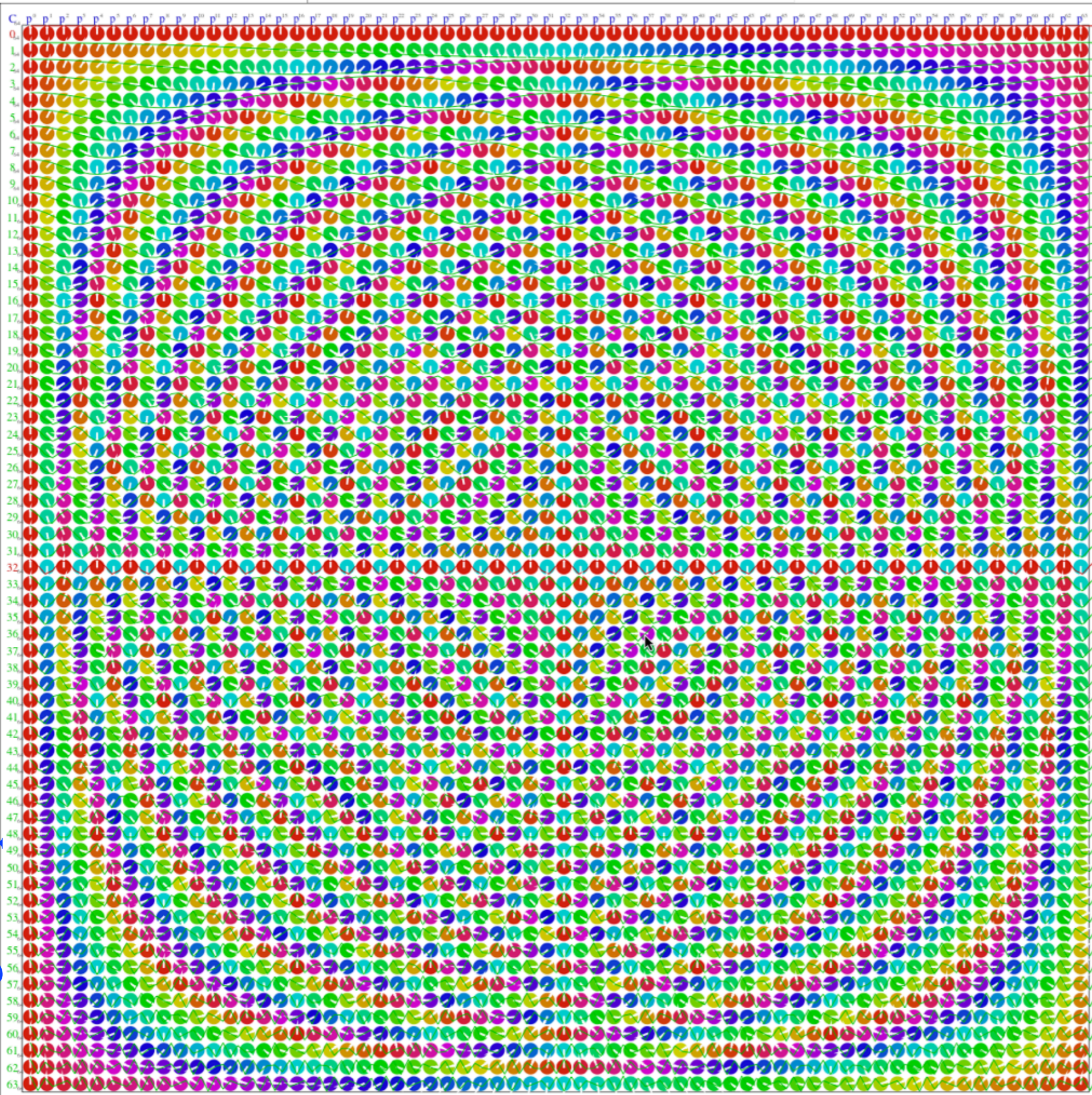

position point $p=0,1,2,\dots$

C_{64}

phasor
character
table

$$\chi_p^m = e^{ik_m r^p}$$

$$= e^{\frac{2\pi i m p}{64}}$$

Invariant phase
“Uncertainty”
hyperbolas:
 $m \cdot p = \text{const.}$

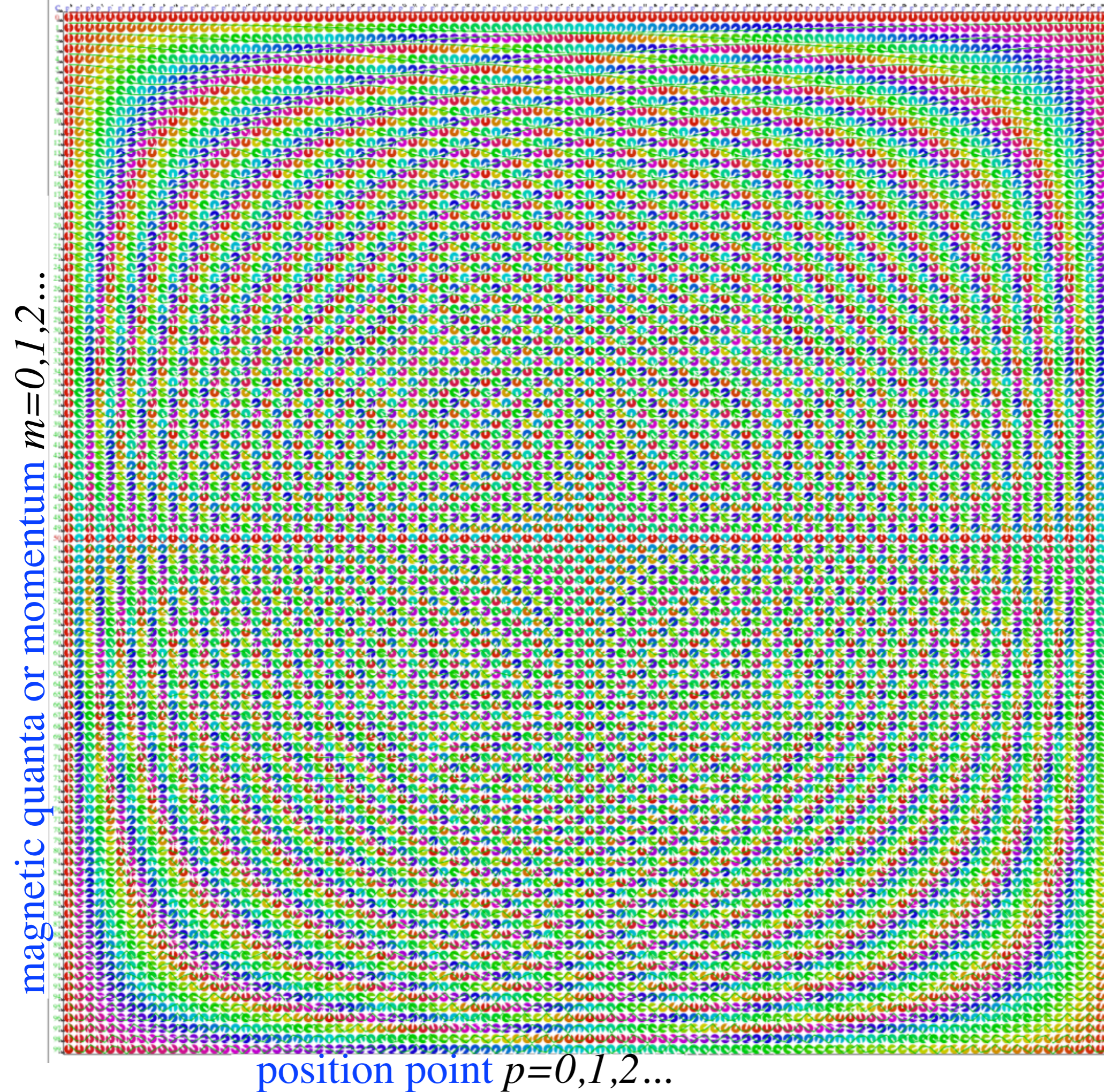

C_{100}

phasor
character
table

$$\chi_p^m = e^{ik_m r^p}$$

$$= e^{\frac{2\pi i m p}{100}}$$

Invariant phase
“Uncertainty”
hyperbolas:
 $m \cdot p = const.$

magnetic quanta or momentum $m=0,1,2\dots$

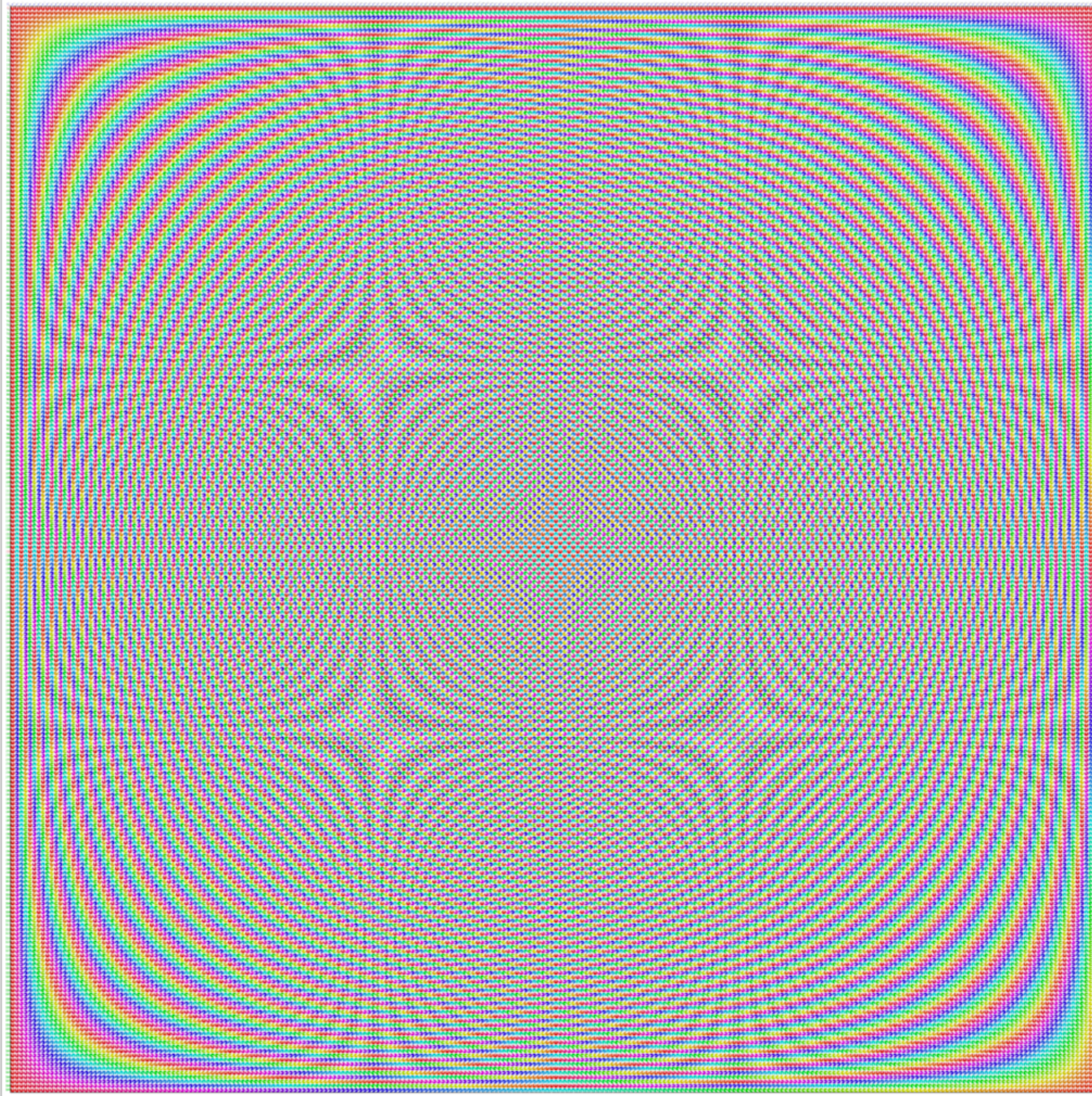

position point $p=0,1,2\dots$

C_{256}

phasor
character
table

$$\chi_p^m = e^{ik_m r^p}$$
$$= e^{\frac{2\pi i m p}{256}}$$

Invariant phase
“Uncertainty”
hyperbolas:
 $m \cdot p = \text{const.}$

[WaveIt C₂₅₆ Character Phasors
Web Simulation](#)

Wave resonance in cyclic symmetry

Harmonic oscillator with cyclic C_2 symmetry

C_2 symmetric (B-type) modes

Harmonic oscillator with cyclic C_3 symmetry

C_3 symmetric spectral decomposition by 3rd roots of unity

Resolving C_3 projectors and moving wave modes

Dispersion functions and standing waves

C_6 symmetric mode model: Distant neighbor coupling

C_6 spectra of gauge splitting by C-type symmetry (complex, chiral, coriolis, current, ..)

C_N symmetric mode models: Made-to order dispersion functions

➔ *Quadratic dispersion models: Super-beats and fractional revivals*

Phase arithmetic

C_N Symmetric Mode Models: Made-to-Order Dispersion (and wave dynamics)

(Making pure linear $\omega=ck$, quadratic $\omega=ck^2$, etc. ?)

Archetypical Examples of Dispersion Functions

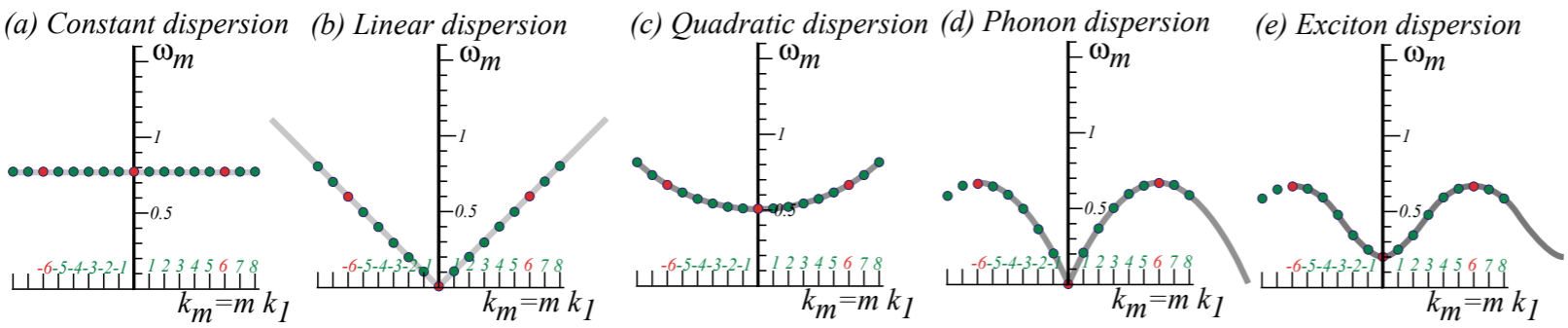

Applications:

Uncoupled pendulums	Weakly coupled pendulums (No gravity)	Weakly coupled pendulums (With gravity)	Strongly coupled pendulums (No gravity)	Strongly coupled pendulums (With gravity)
Movie marquis Xmas lights	Light in vacuum (Exactly) Sound (Approximately)	Light in fiber (Approx) Non-relativistic Schrodinger matter wave	Acoustic mode in solids	Optical mode in solids Relativistic matter (If exact hyperbola)

$$a = k_a \cdot x - \omega_a \cdot t$$

$$b = k_b \cdot x - \omega_b \cdot t$$

$$\frac{e^{ia} + e^{ib}}{2} = e^{i\frac{a+b}{2}} \left(\frac{e^{i\frac{a-b}{2}} + e^{-i\frac{a-b}{2}}}{2} \right)$$

$$= e^{i\frac{a+b}{2}} \cos\left(\frac{a-b}{2}\right)$$

Reading Wave Velocity From Dispersion Function by (k,ω) Vectors

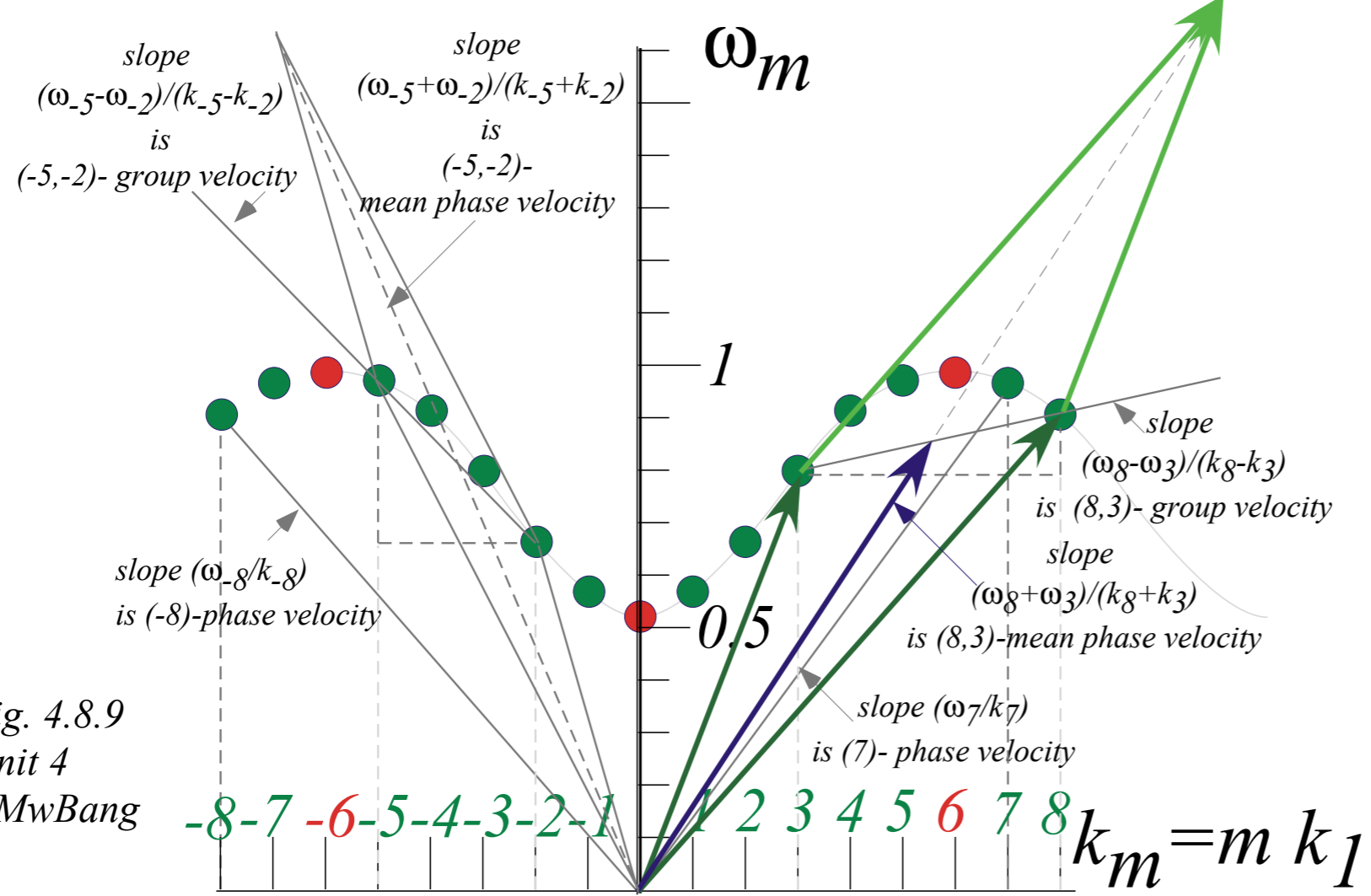

Fig. 4.8.9
Unit 4
CMwBang

Things determined by Dispersion $\omega = \omega(k)$

Individual phase velocity:

$$V_{phase-1} = \frac{\omega(k)}{k}$$

Pairwise phase velocity:

$$V_{phase-2} = \frac{\omega(k_a) + \omega(k_b)}{k_a + k_b}$$

Pairwise group velocity:

$$V_{group-2} = \frac{\omega(k_a) - \omega(k_b)}{k_a - k_b}$$

Simulating Complex Systems

With Simpler Ones

Made of Quantum Dots

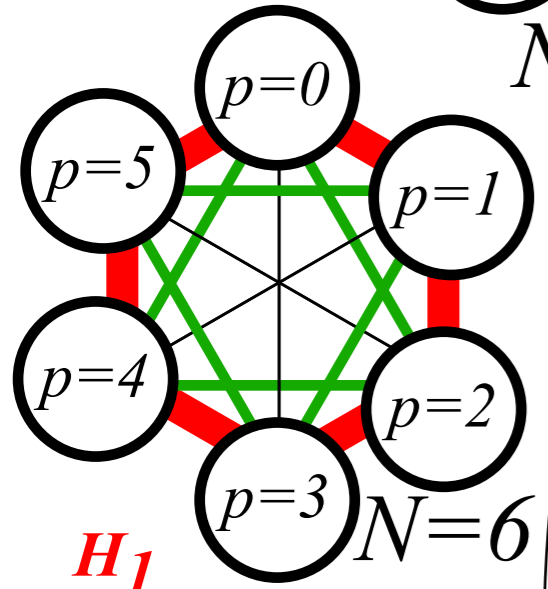
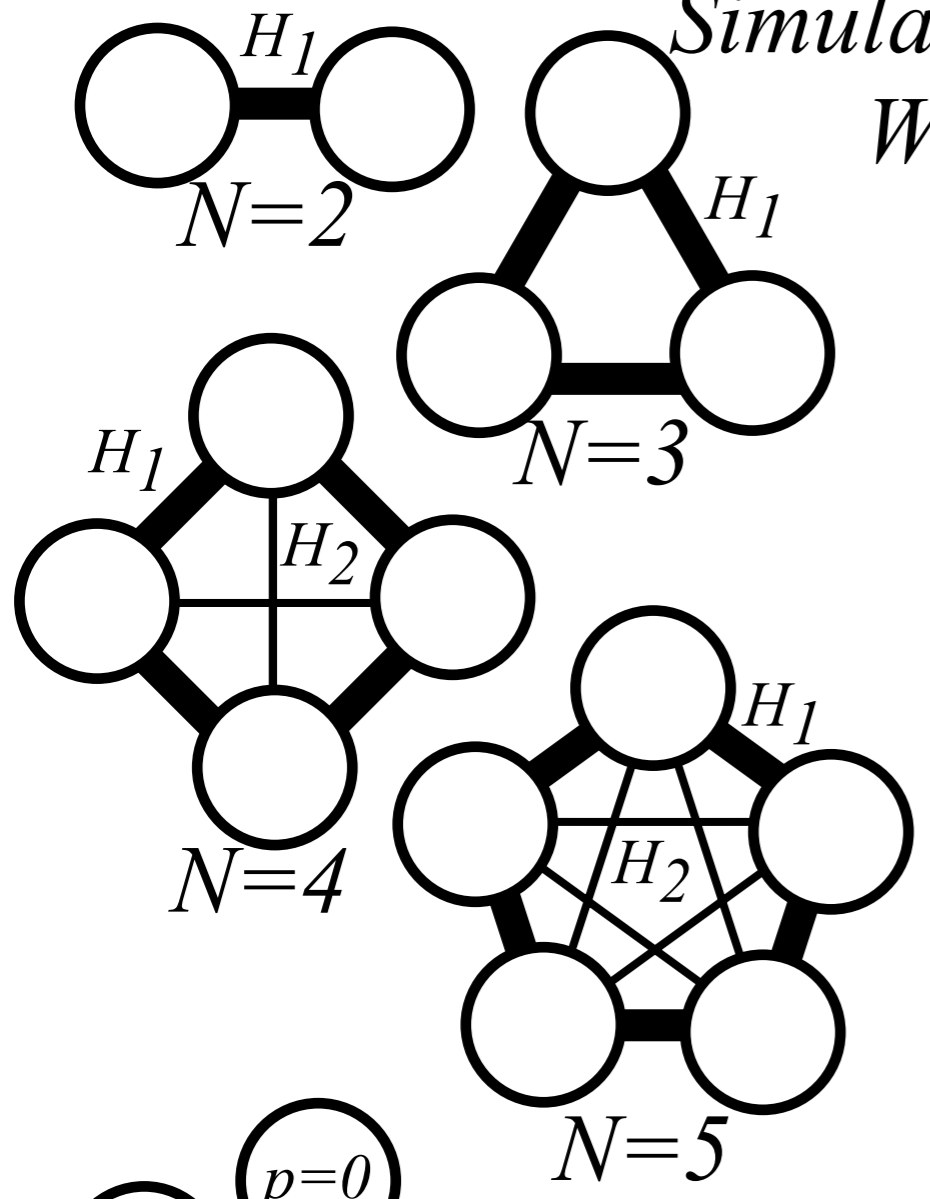

Hexagonal 2D Rotor

H_0	H_1	H_2	H_3	H_2	H_1
H_1	H_0	H_1	H_2	H_3	H_2
H_2	H_1	H_0	H_1	H_2	H_3
H_3	H_2	H_1	H_0	H_1	H_2
H_2	H_3	H_2	H_1	H_0	H_1
H_1	H_2	H_3	H_2	H_1	H_0

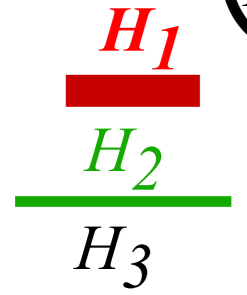

Simulating Complex Systems

With Simpler Ones

Made of Quantum Dots

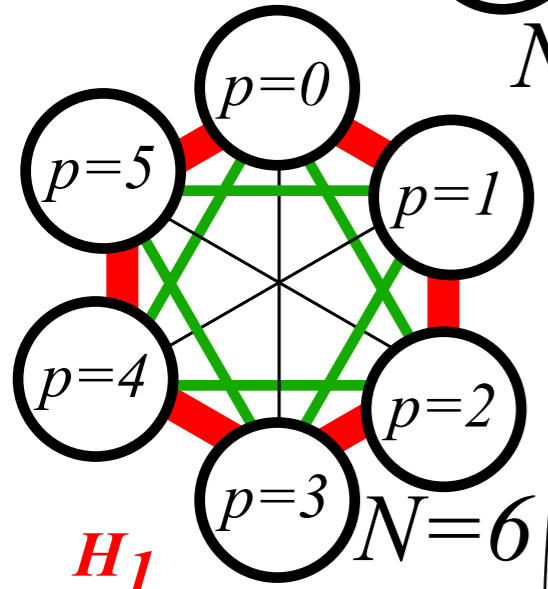
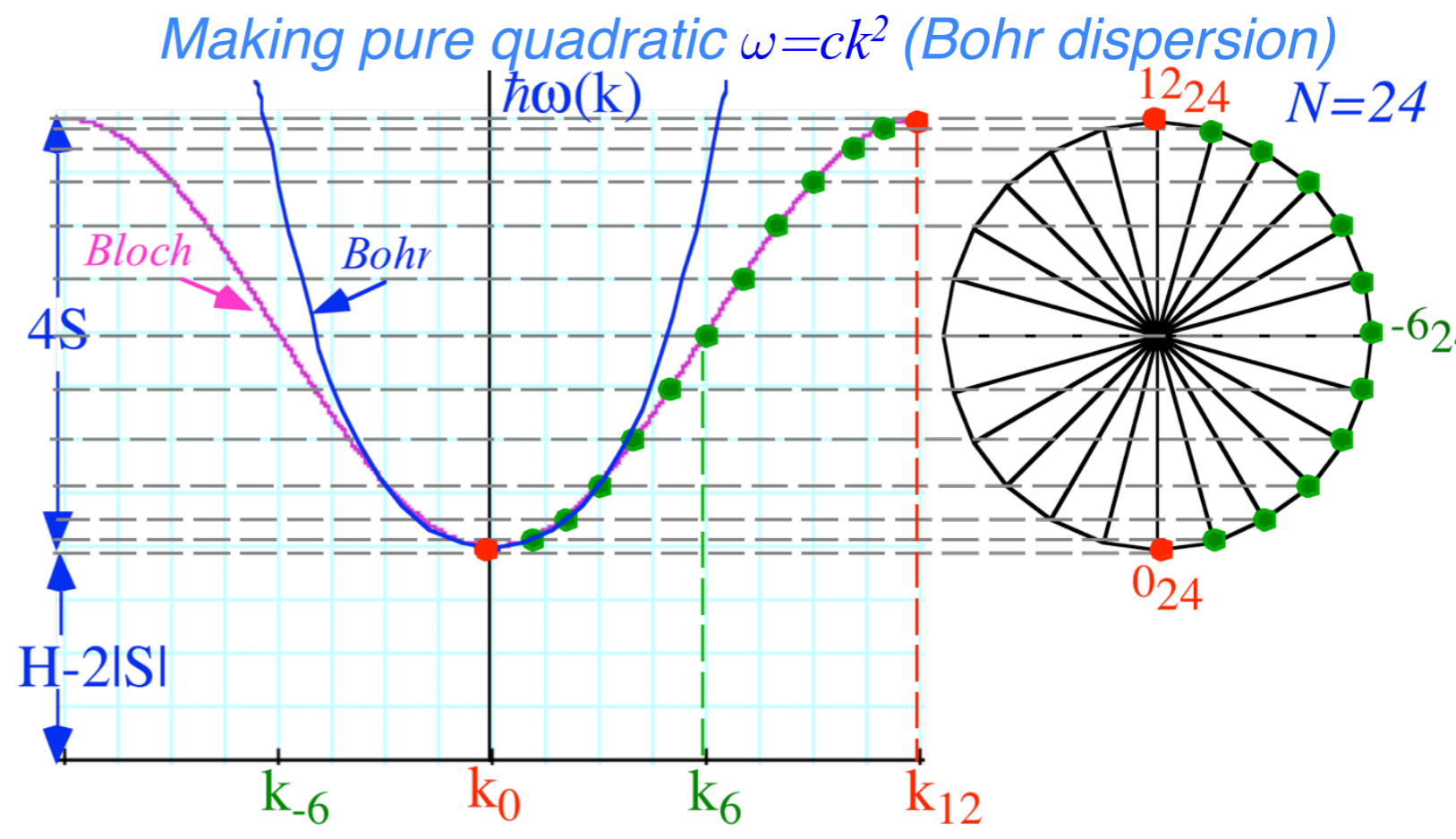
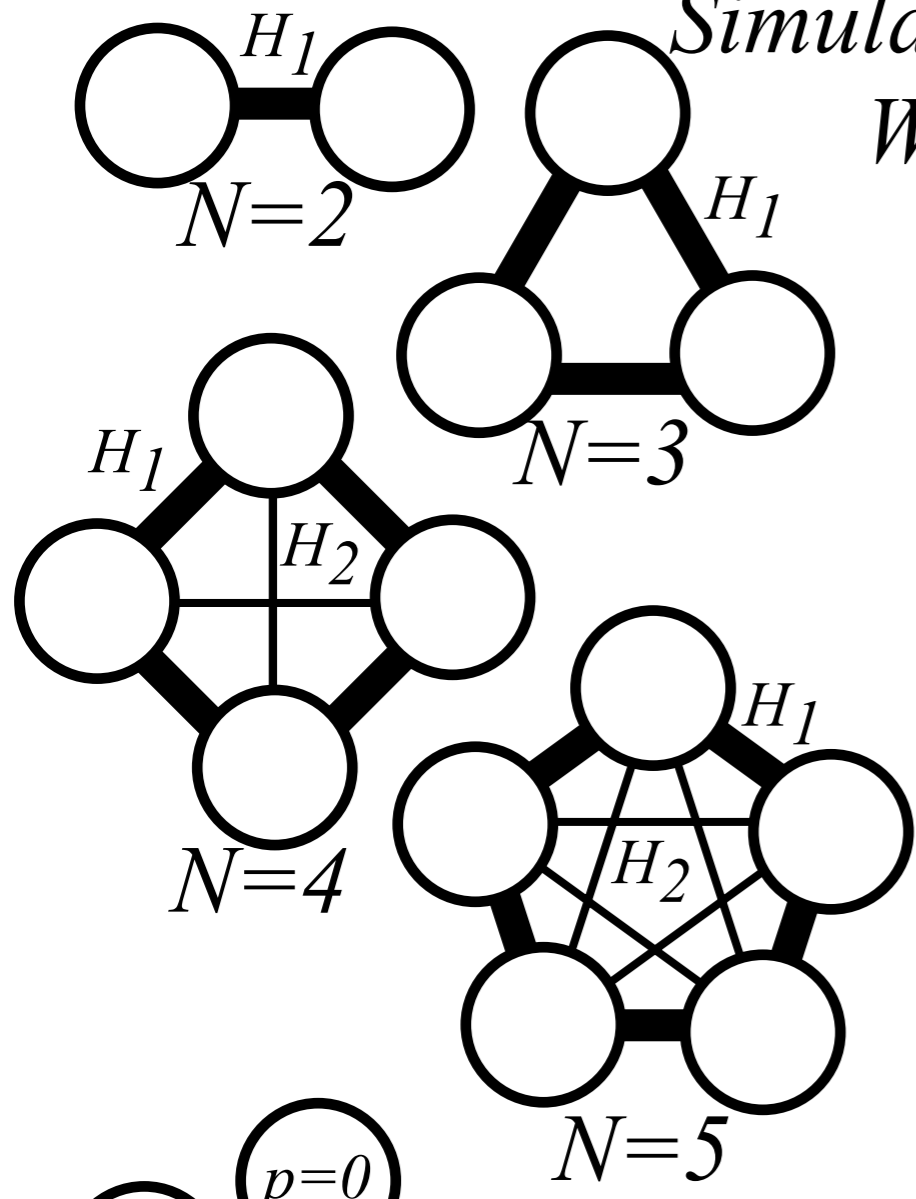

Hexagonal 2D Rotor

H_0	H_1	H_2	H_3	H_2	H_1
H_1	H_0	H_1	H_2	H_3	H_2
H_2	H_1	H_0	H_1	H_2	H_3
H_3	H_2	H_1	H_0	H_1	H_2
H_2	H_3	H_2	H_1	H_0	H_1
H_1	H_2	H_3	H_2	H_1	H_0

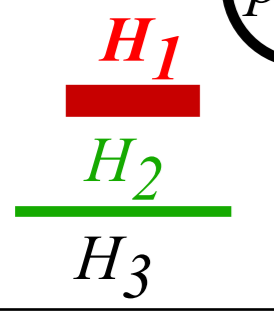

Simulating Complex Systems

[Harter, J. Mol. Spec. 210, 166-182 (2001)]

With Simpler Ones

Made of Quantum Dots

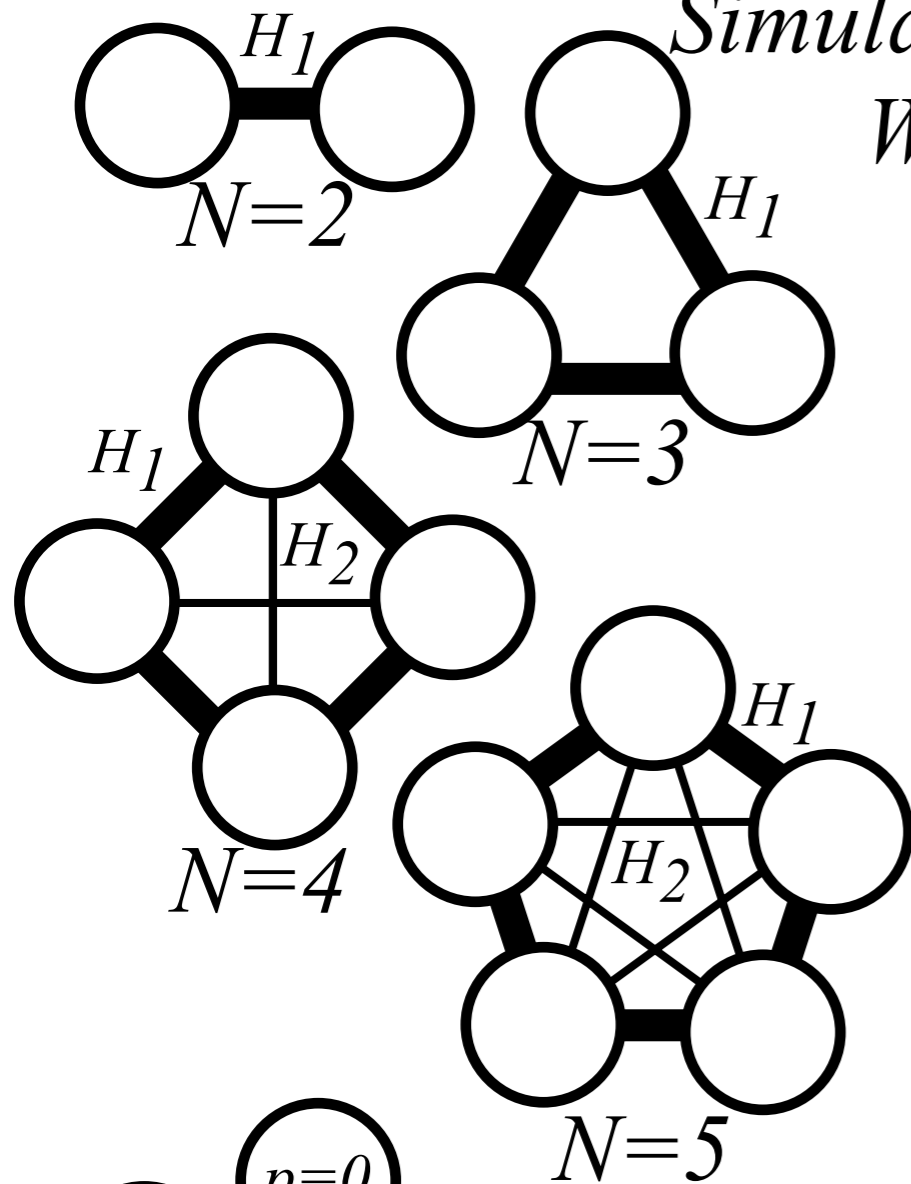

Making pure quadratic $\omega = ck^2$ (Bohr dispersion)

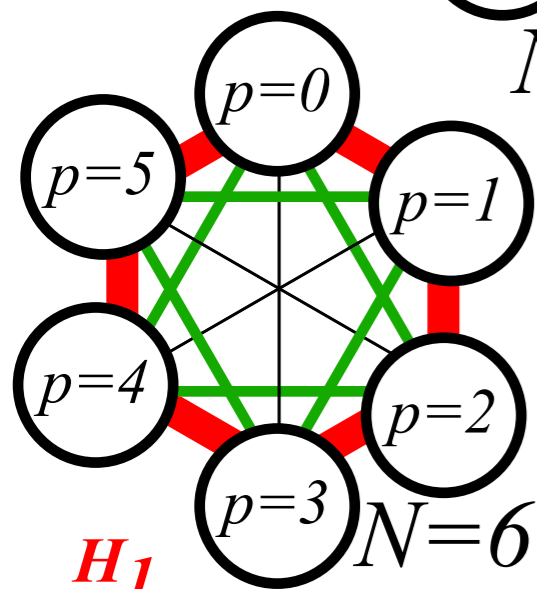
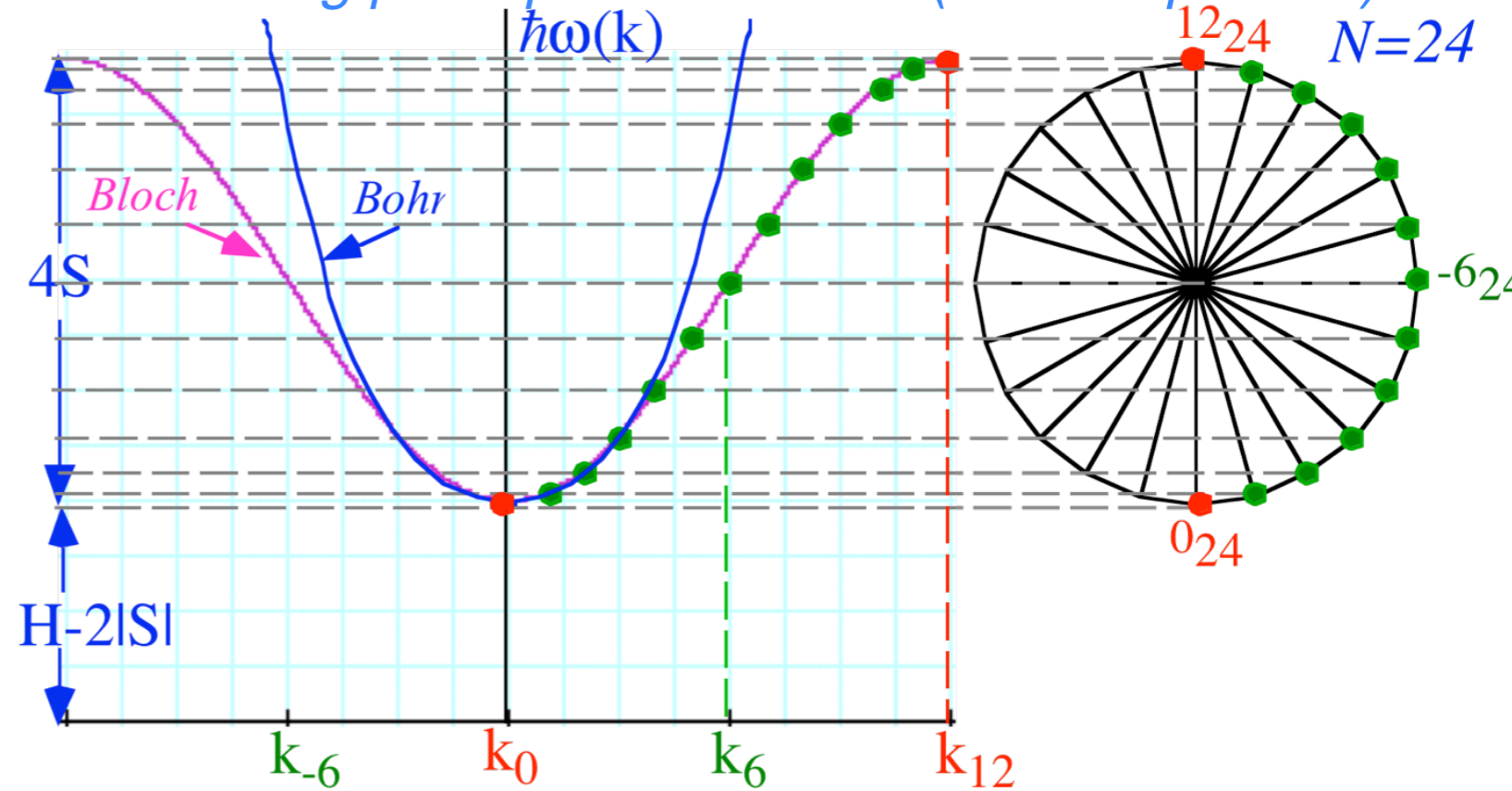

Hexagonal 2D Rotor

$$\begin{pmatrix} H_0 & H_1 & H_2 & H_3 & H_2 & H_1 \\ H_1 & H_0 & H_1 & H_2 & H_3 & H_2 \\ H_2 & H_1 & H_0 & H_1 & H_2 & H_3 \\ H_3 & H_2 & H_1 & H_0 & H_1 & H_2 \\ H_2 & H_3 & H_2 & H_1 & H_0 & H_1 \\ H_1 & H_2 & H_3 & H_2 & H_1 & H_0 \end{pmatrix}$$

	H_0	H_1	H_2	H_3	H_4	H_5	H_6	H_7	H_8
$N=2$	1/2	-1/2							
$N=3$	2/3	-1/3							
$N=4$	3/2	-1	1/2						
$N=5$	2	-1.1708	0.1708						
$N=6$	19/6	-2	2/3	-1/2					
$N=7$	4	-2.393	0.51	-0.1171					
$N=8$	11/2	-3.4142	1	-0.5858	1/2				
$N=9$	20/3	-4.0165	0.9270	-1/3	0.0895				
$N=10$	17/2	-5.2361	1.4472	-0.7639	0.5528	-1/2			
$N=11$	10	-6.0442	1.4391	-0.5733	0.2510	-0.0726			
$N=12$	73/6	-7.4641	2	-1	2/3	-0.5359	1/2		
$N=13$	14	-8.4766	2.0500	-0.8511	0.4194	-0.2028	0.06116		
$N=14$	33/2	-10.098	2.6560	-1.2862	0.8180	-0.6160	0.5260	-1/2	
$N=15$	57/3	-11.314	2.7611	-1.1708	0.6058	-1/3	0.1708	-0.0528	
$N=16$	43/2	-13.137	3.4142	-1.6199	1	-0.7232	0.5858	-0.5198	1/2
$N=17$	24	-14.557	3.5728	-1.5340	0.81413	-0.4732	0.2781	-0.1479	0.0465

Wave resonance in cyclic symmetry

Harmonic oscillator with cyclic C_2 symmetry

C_2 symmetric (B-type) modes

Harmonic oscillator with cyclic C_3 symmetry

C_3 symmetric spectral decomposition by 3rd roots of unity

Resolving C_3 projectors and moving wave modes

Dispersion functions and standing waves

C_6 symmetric mode model: Distant neighbor coupling

C_6 spectra of gauge splitting by C-type symmetry (complex, chiral, coriolis, current, ..)

C_N symmetric mode models: Made-to order dispersion functions

Quadratic dispersion models: Super-beats and fractional revivals

➔ *Phase arithmetic*

2-level-system and C_2 symmetry phase dynamics

C_2 Character Table describes eigenstates

symmetric A_1

	$1 = r^0$	$r = r^1$
$0 \bmod 2$	1	1
$\pm 1 \bmod 2$	1	-1

vs.

antisymmetric A_2

C_2 Phasor-Character Table

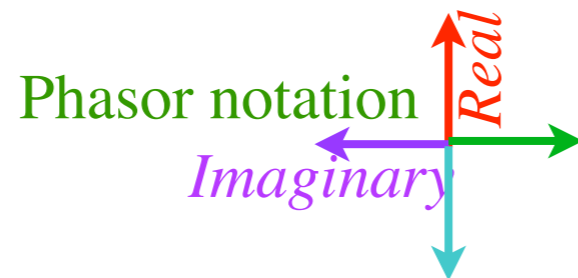
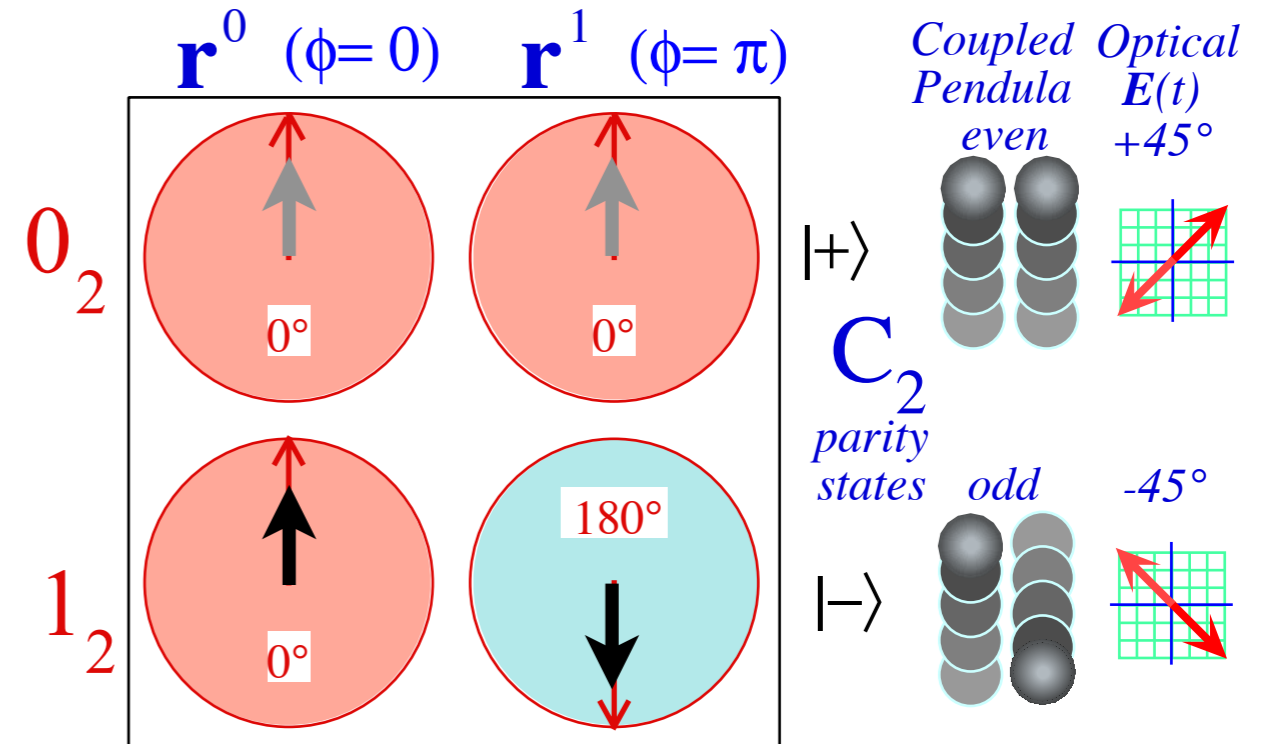

Phasor C_2 Characters describe local state beats

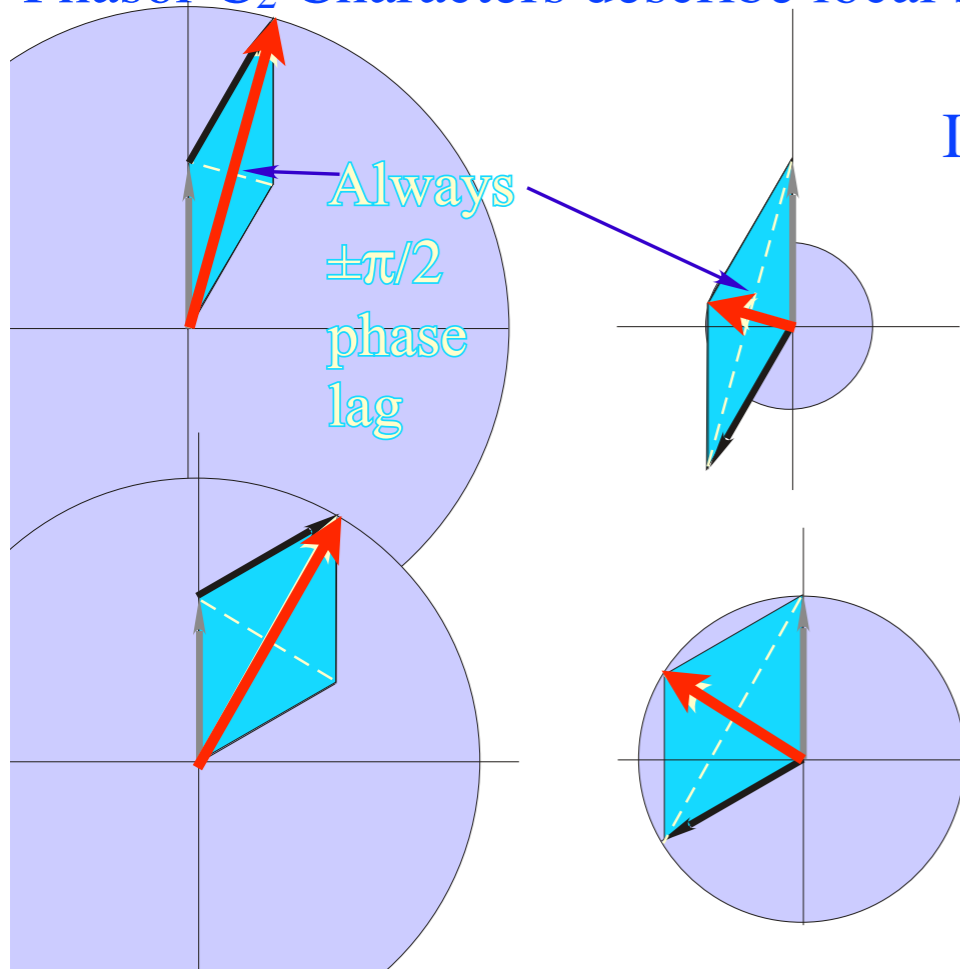

Initial sum

1/4-beat

1/2-beat

3/4-beat

full-beat is simplest example of a *revival*

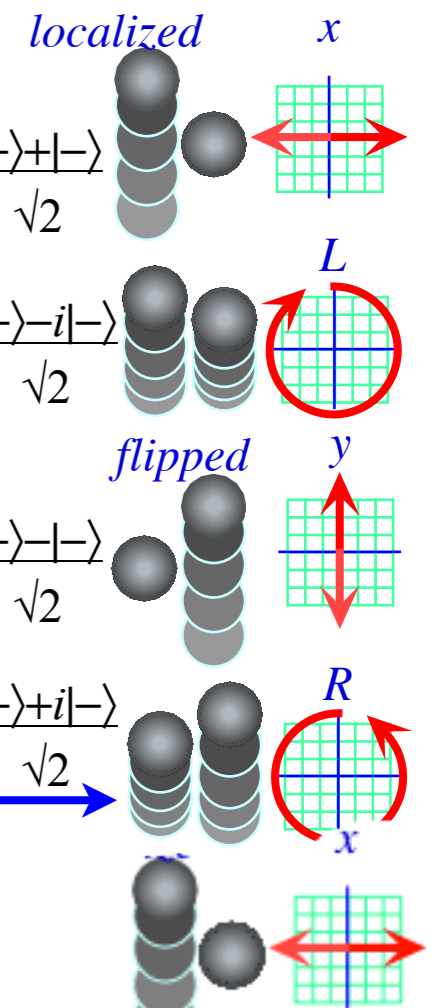

2-level-system and C_2 symmetry phase dynamics

C_2 Phasor-Character Table

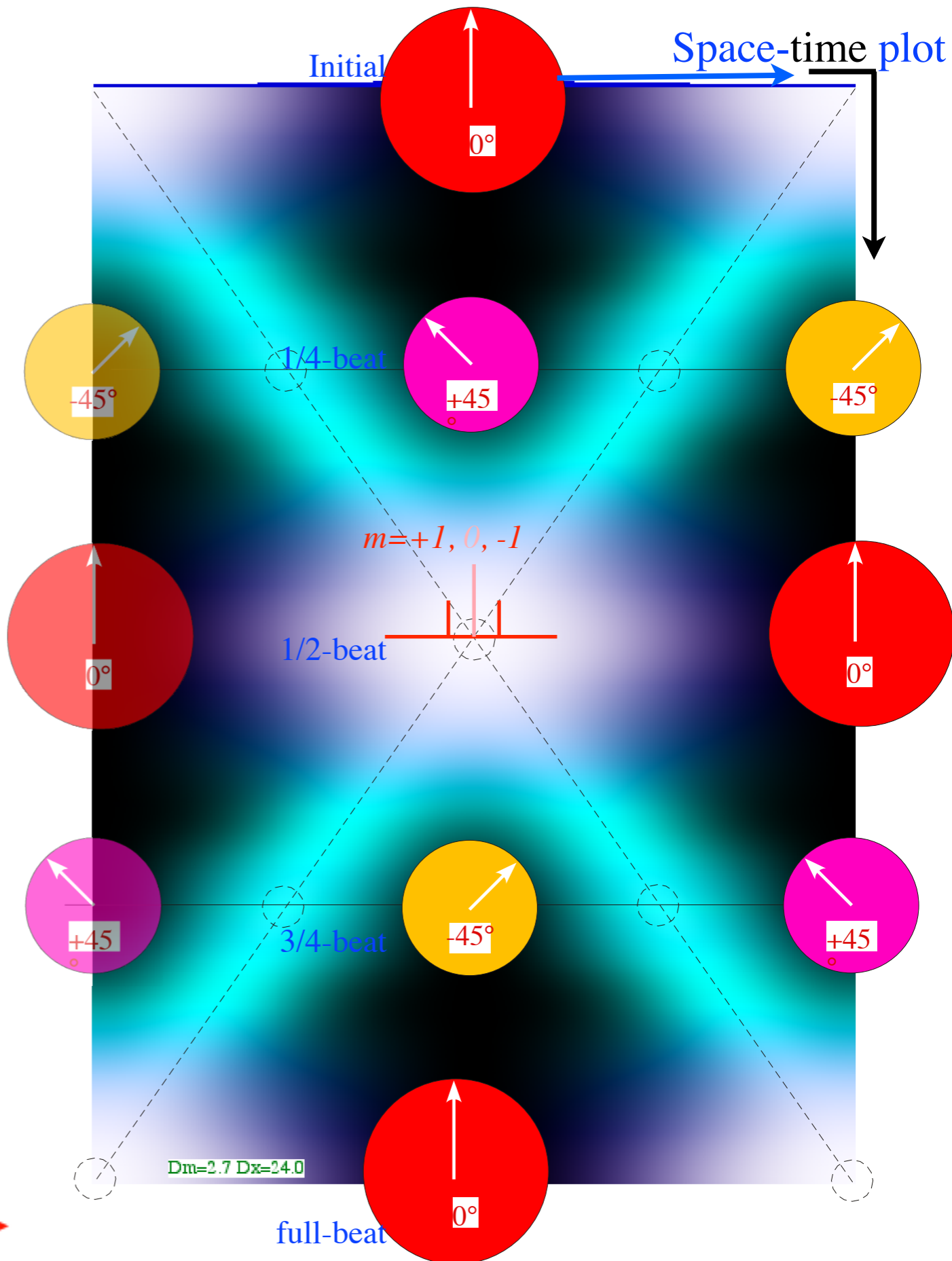
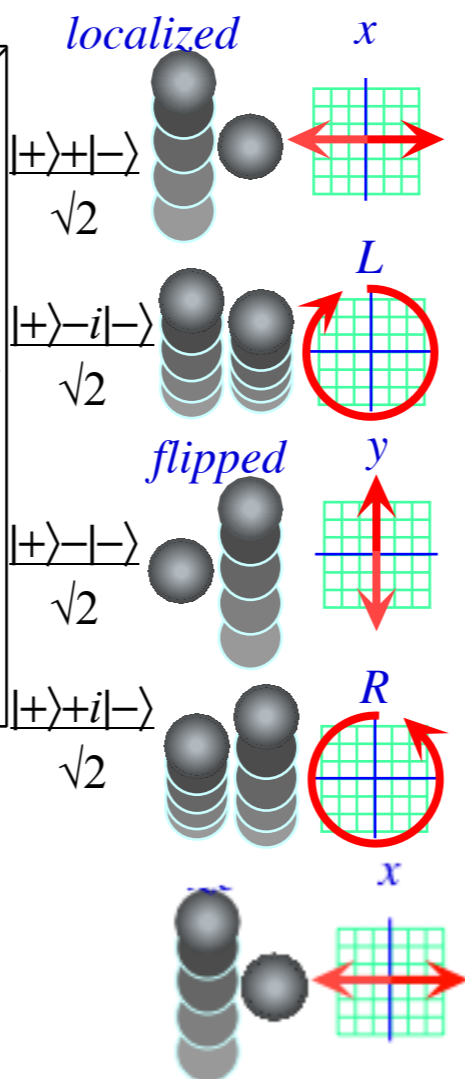
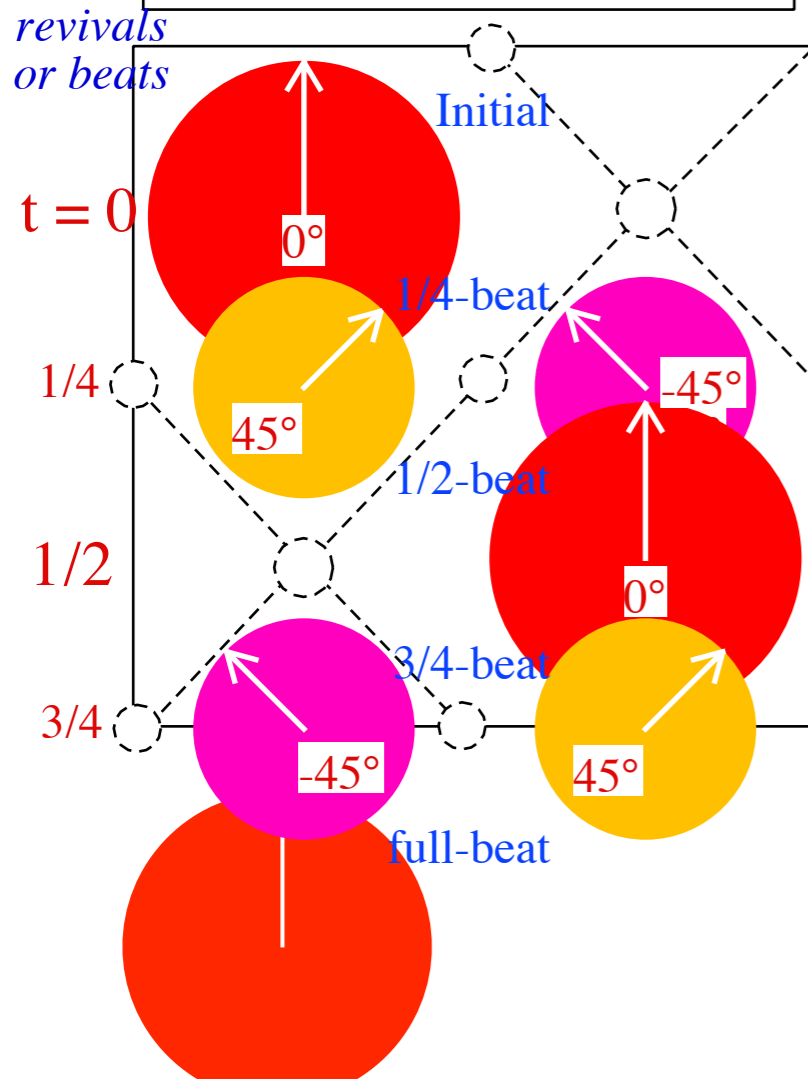
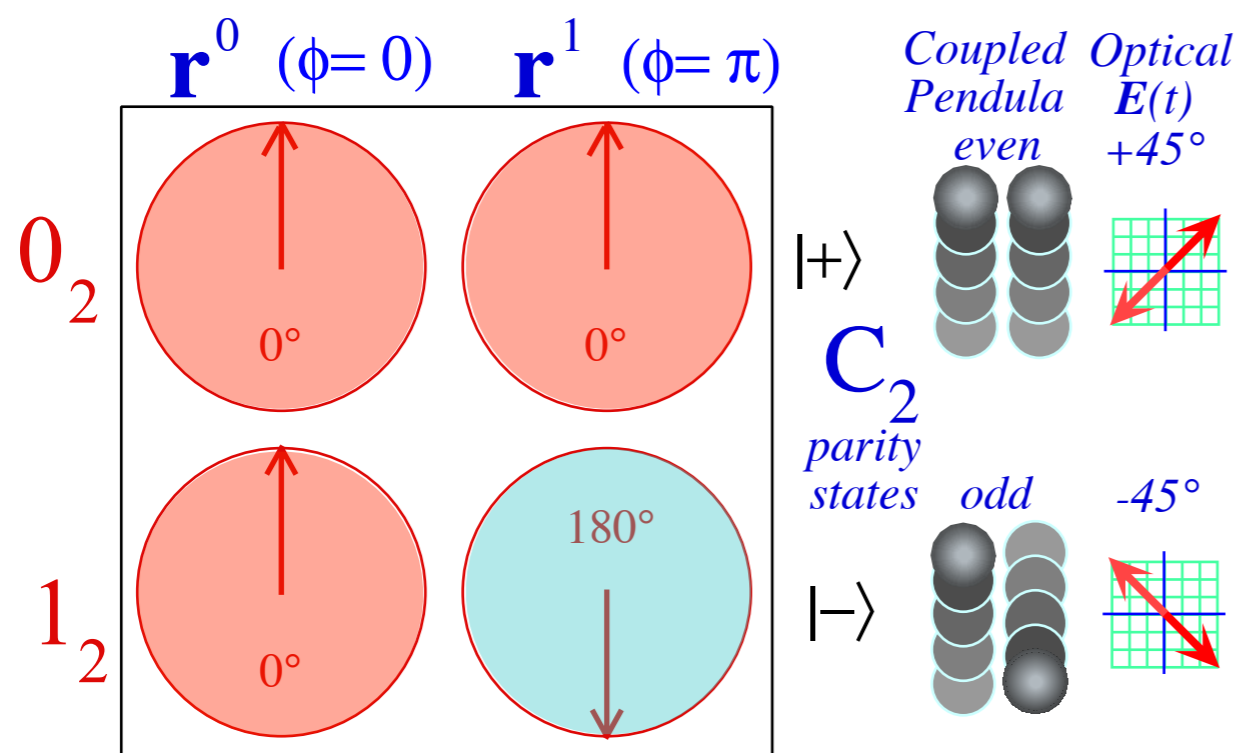

2-level-system and C_2 symmetry phase dynamics

C_2 Phasor-Character Table

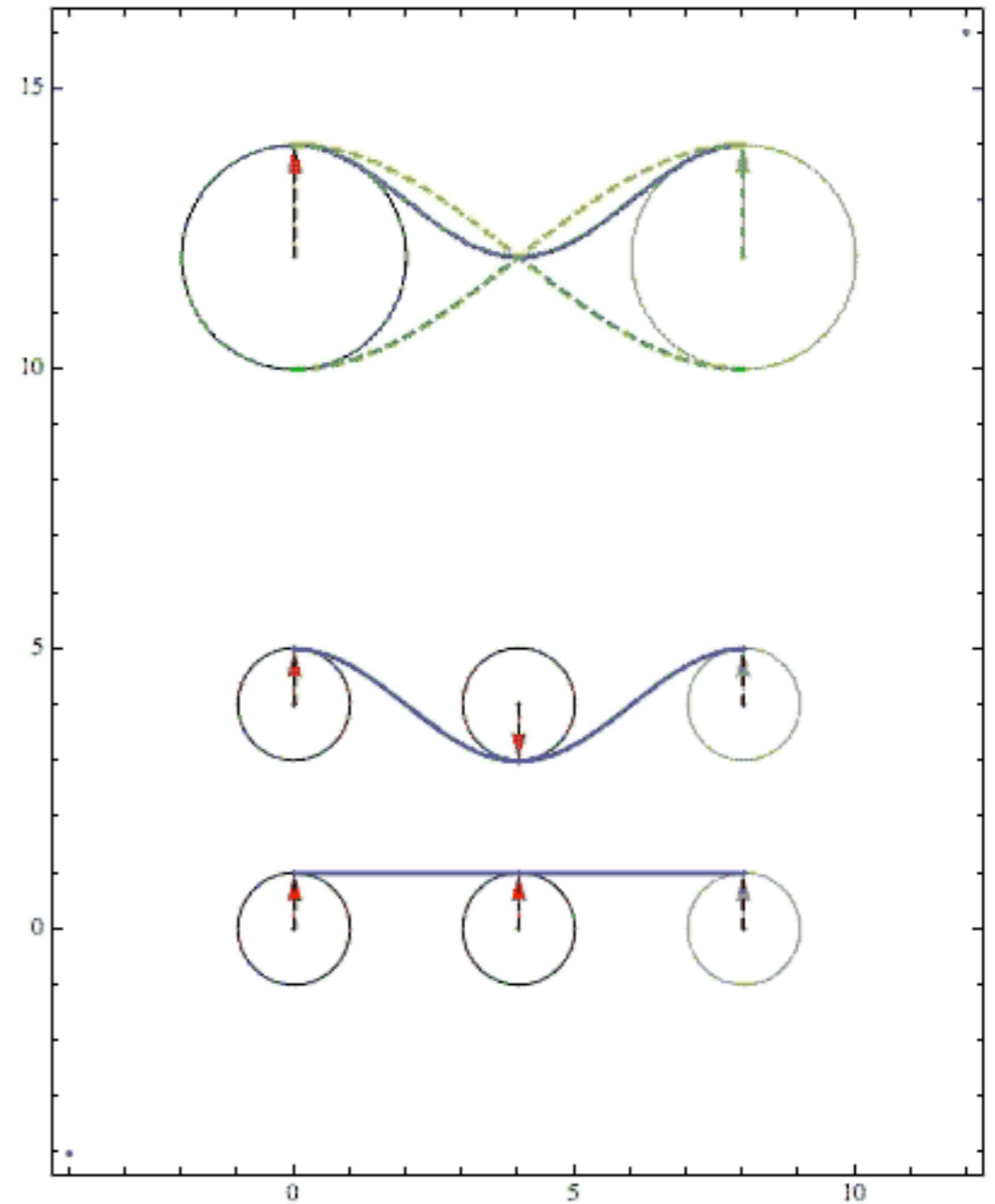
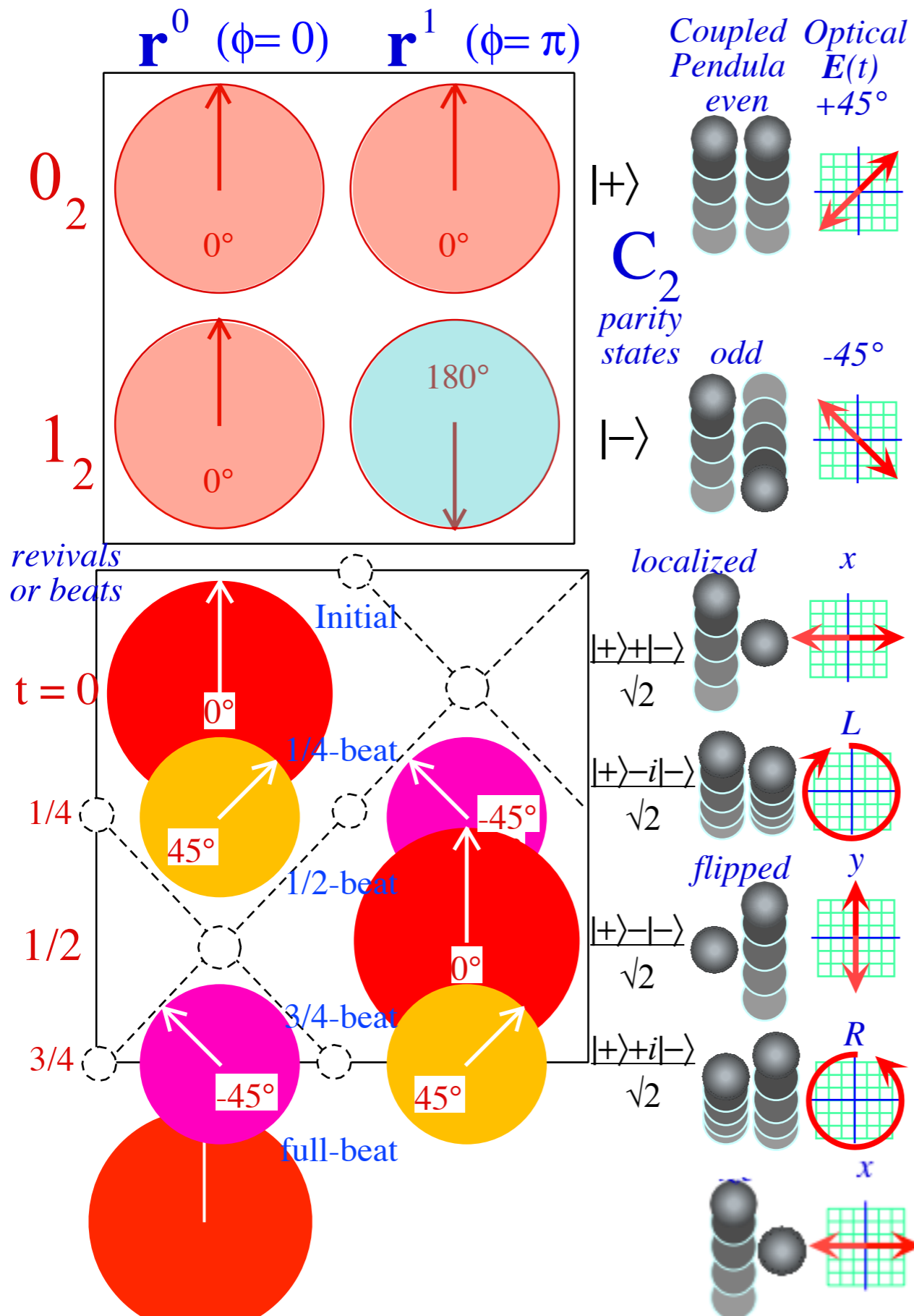

C_3 symmetry phase in 1, 2, or 3-level-systems

C_3 Eigenstate Characters

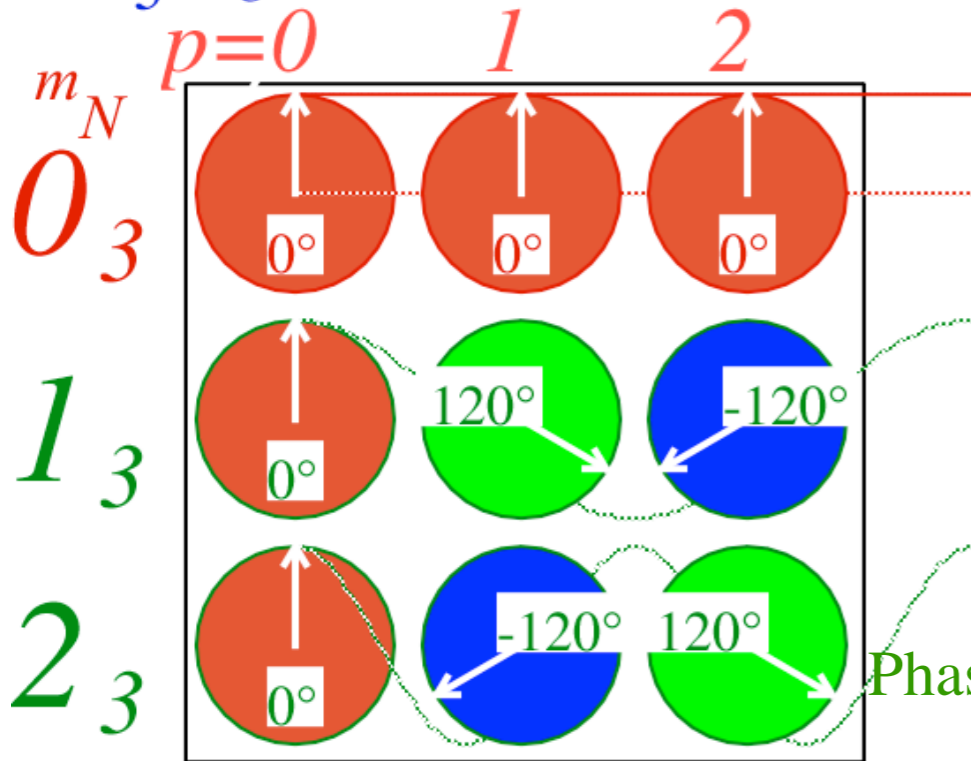

Non-chiral C_{3v} system

Chiral
"quantum-Hall-like"
systems
deserve special treatment

Phasor notation
Real
Imaginary

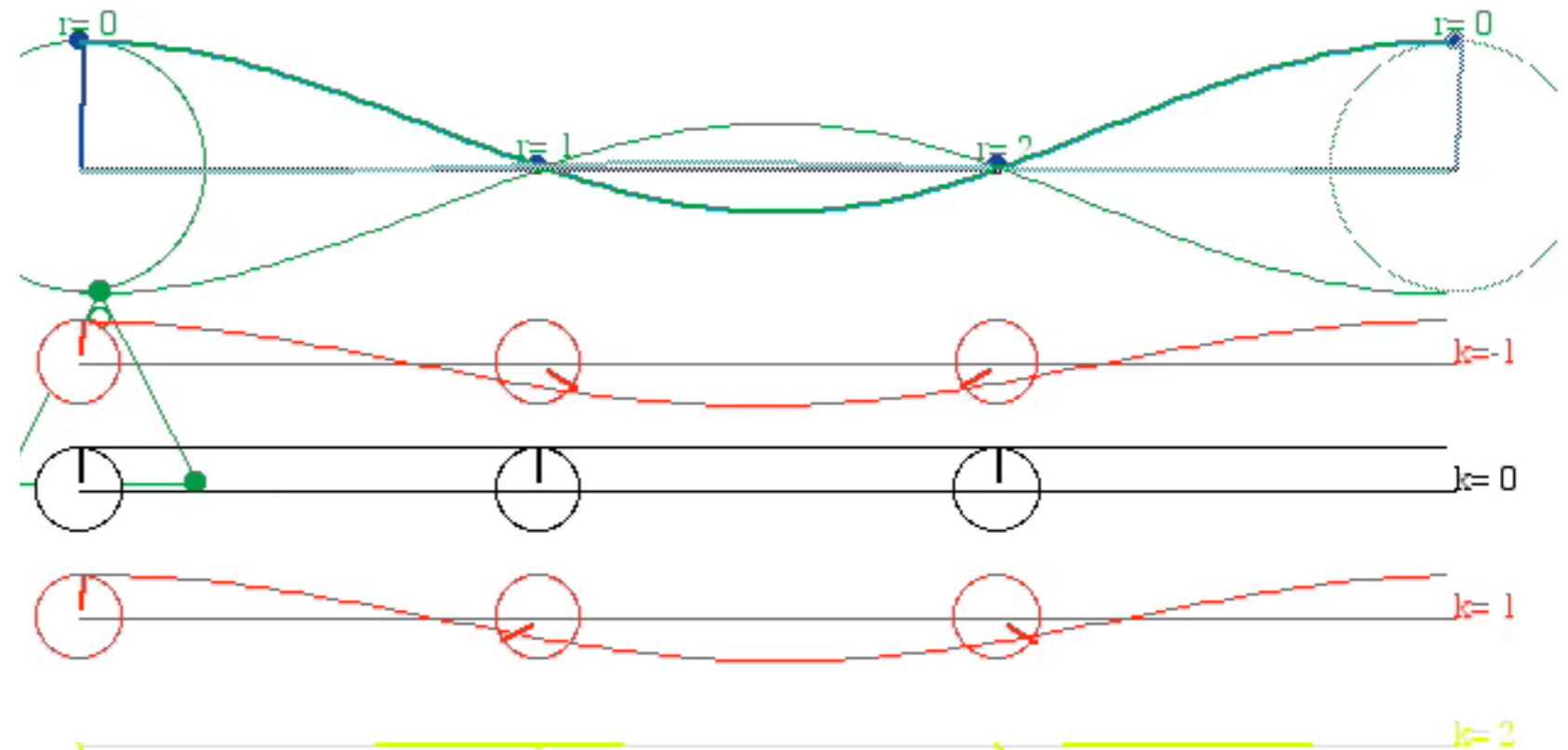

C_3 Revivals

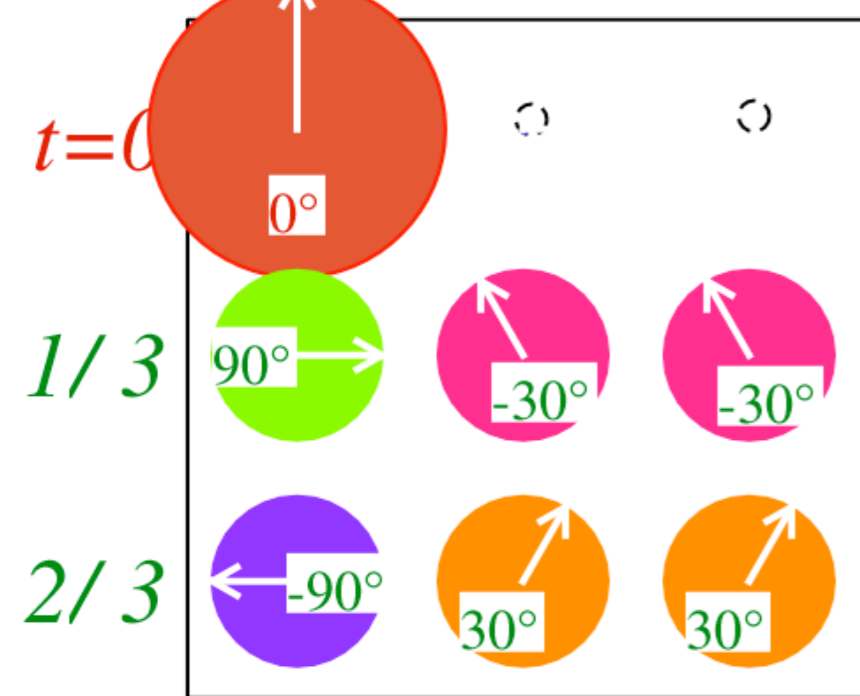

C_4 symmetry phase in 1, 2, 3, or 4 level-systems

C_4 Eigenstate Characters

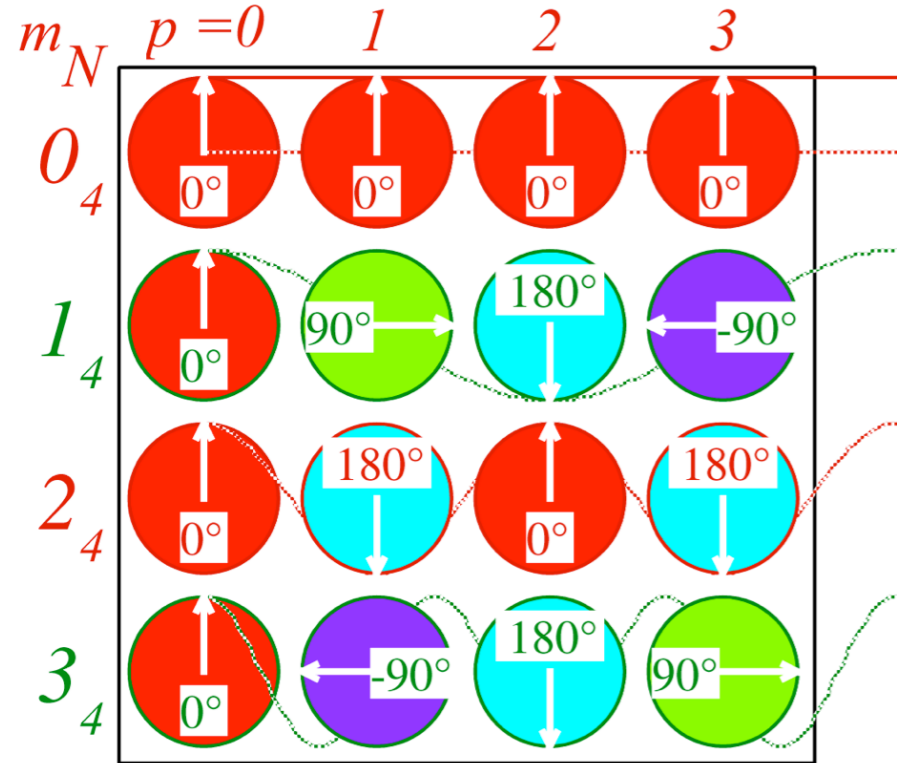

*Non-chiral
 C_{4v} system*

C_4 Revivals

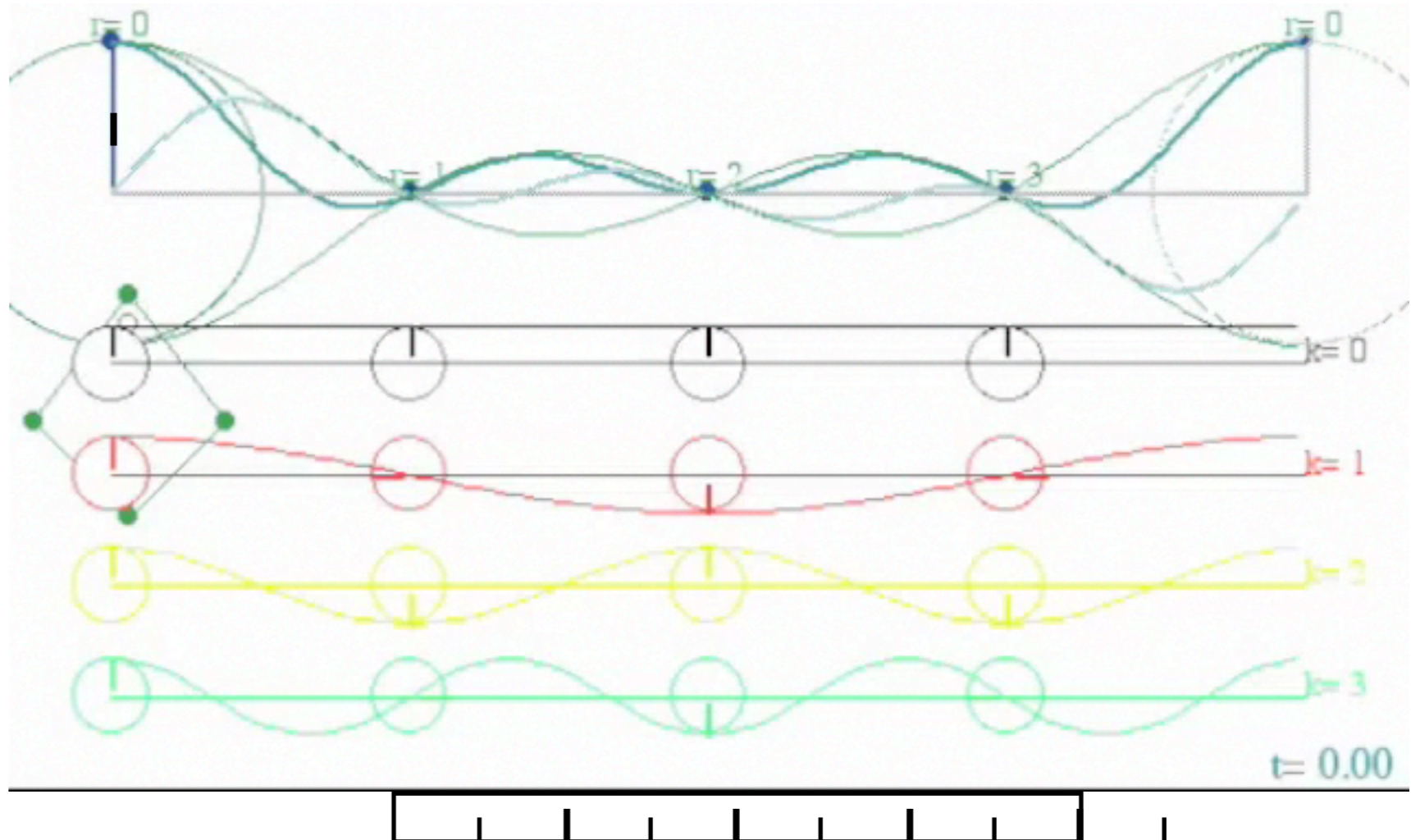
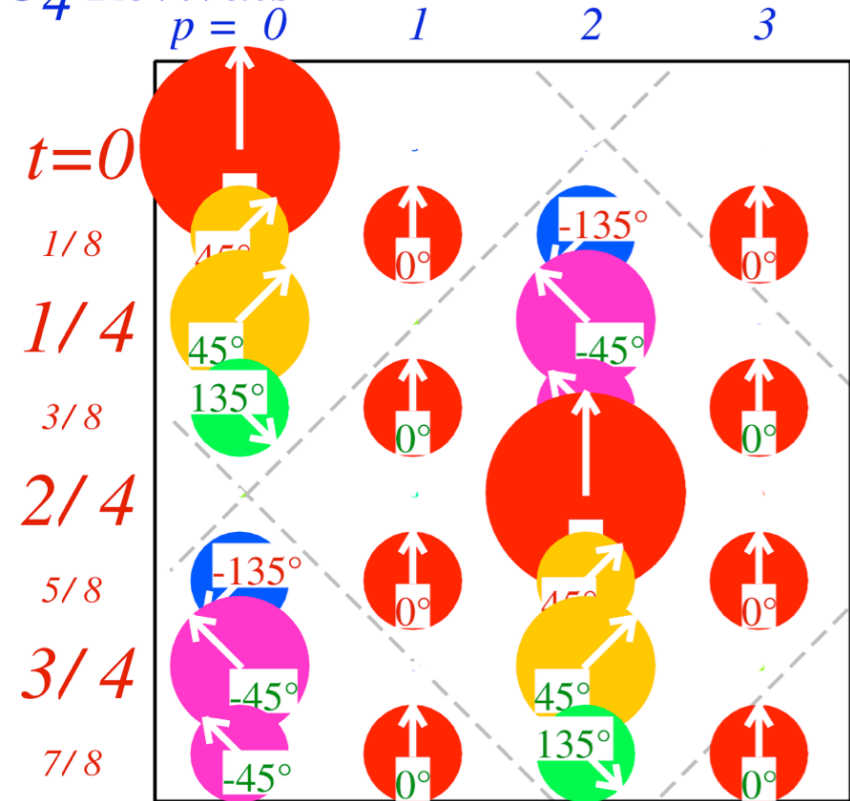

C_5 symmetry phase in 1, 2, ..., 5 level-systems

C_5 Eigenstate Characters

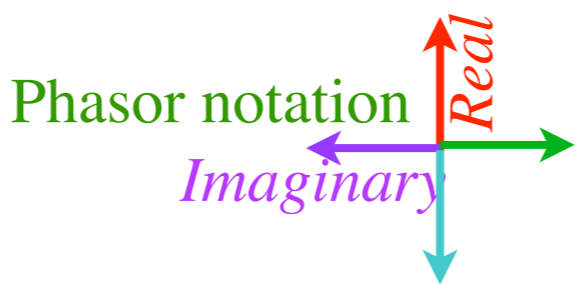
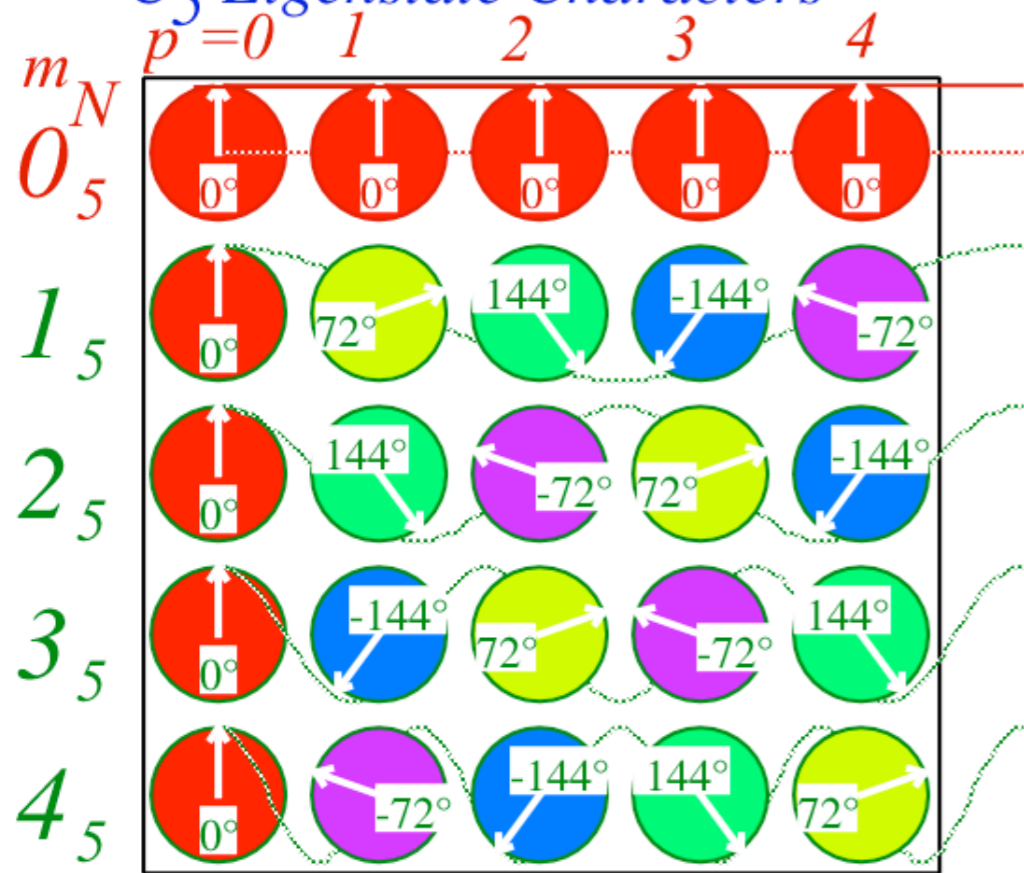

C_5 Revivals

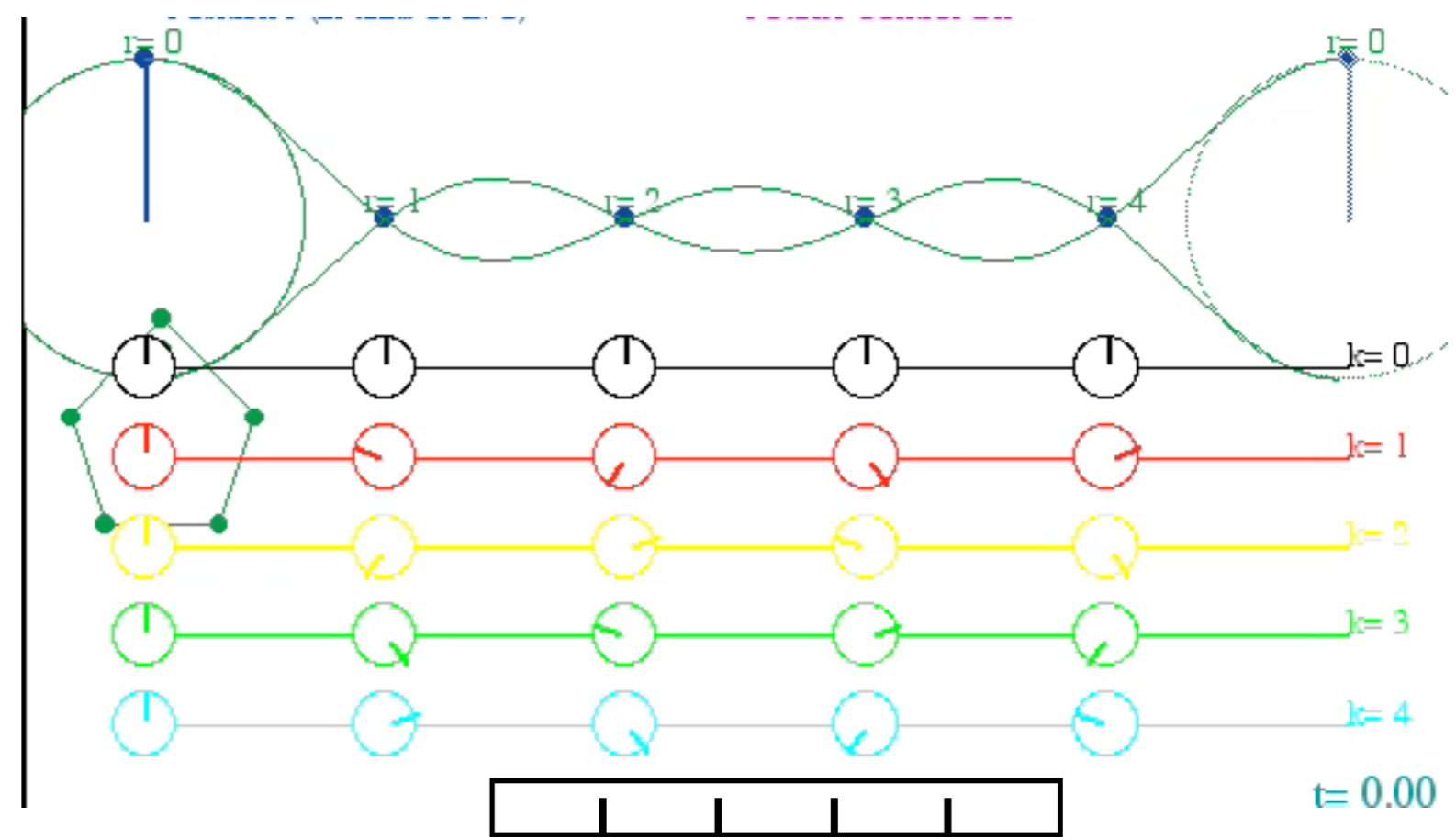
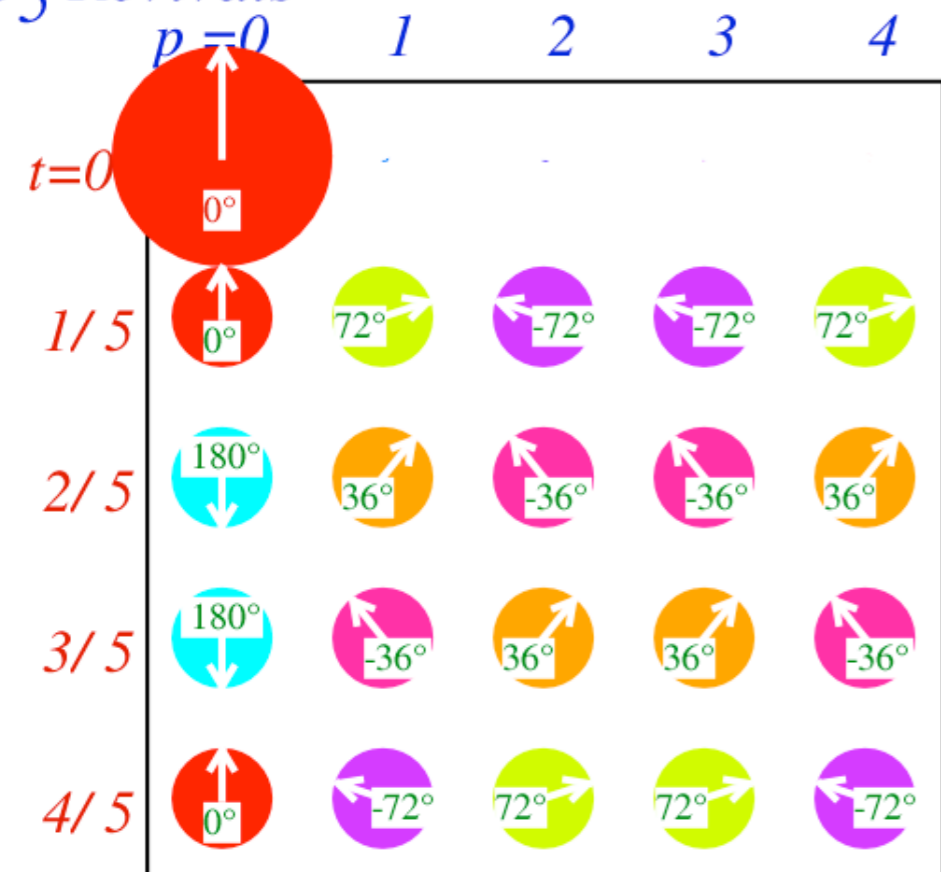

C_6 symmetry phase in 1, ...6 level-systems

C_6 Eigenstate Characters

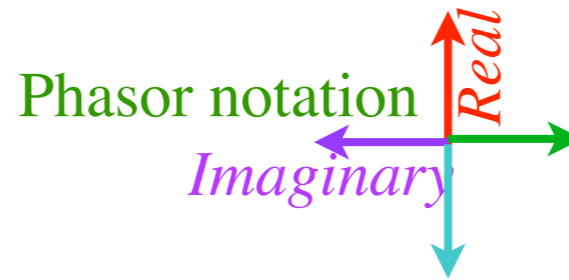
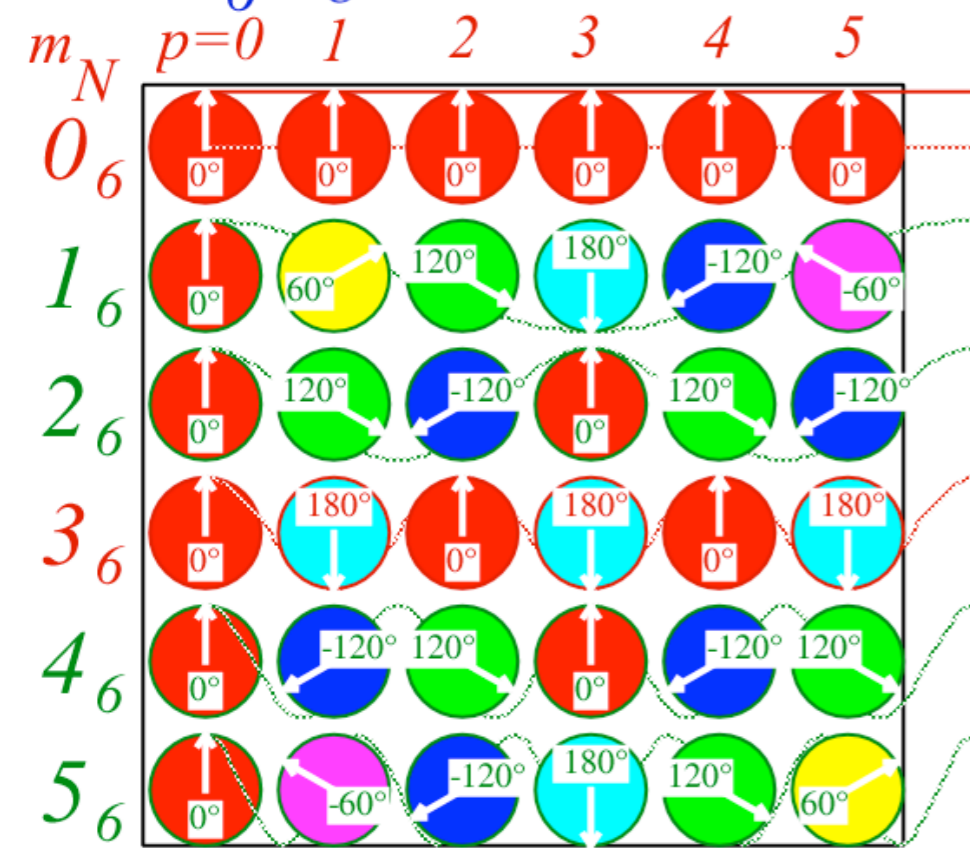

C_6 Revivals

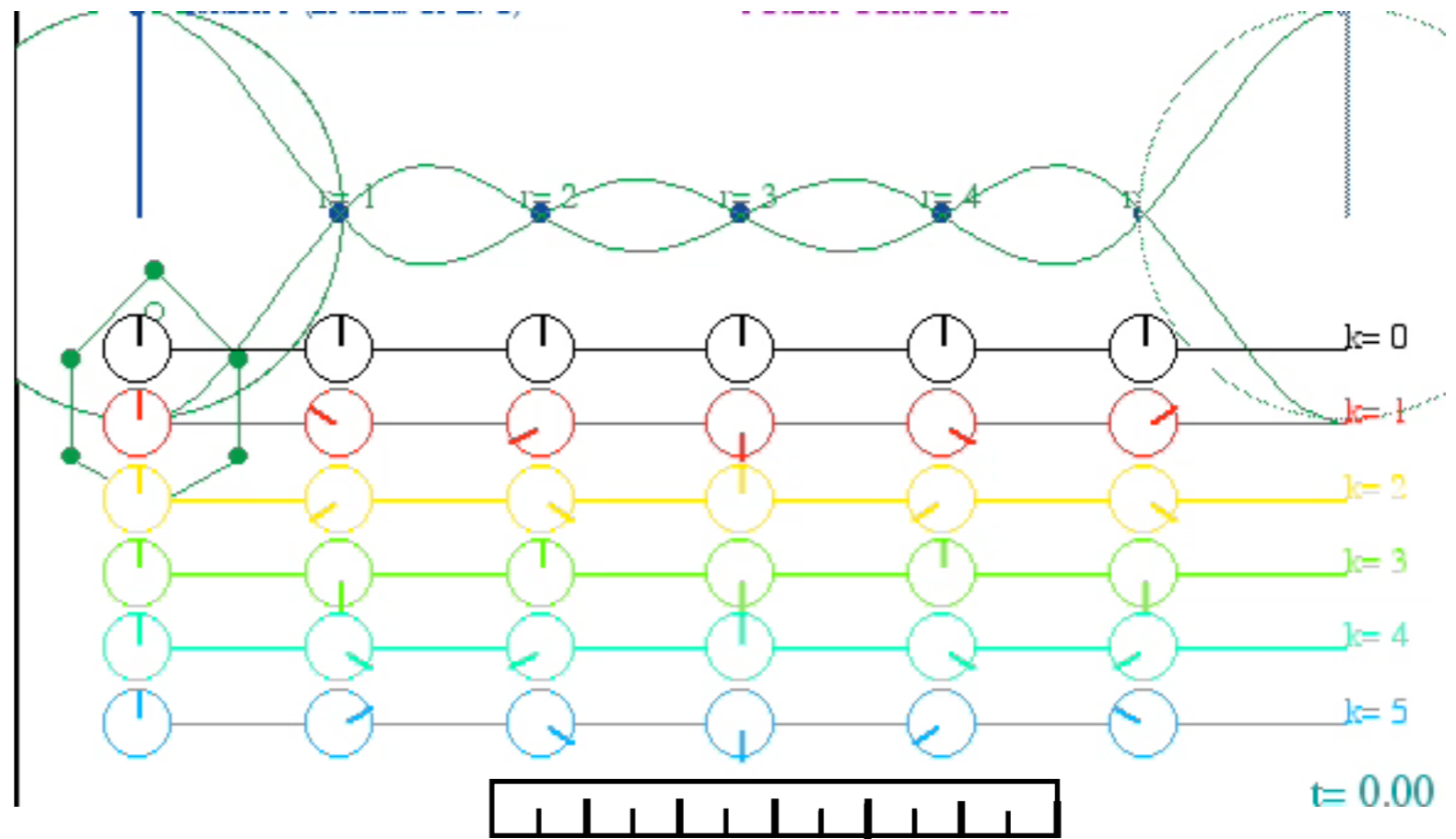
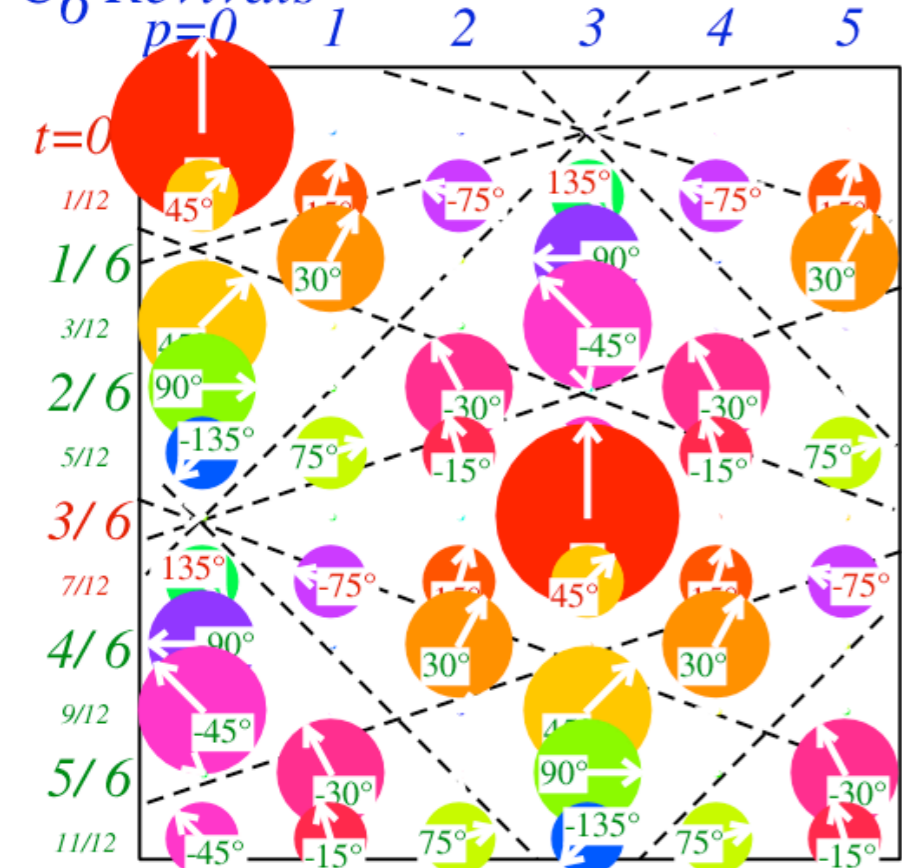

C_m algebra of revival-phase dynamics

Discrete 3-State or Trigonal System
(Tesla's 3-Phase AC)

Discrete 6-State or Hexagonal System
(6-Phase AC)

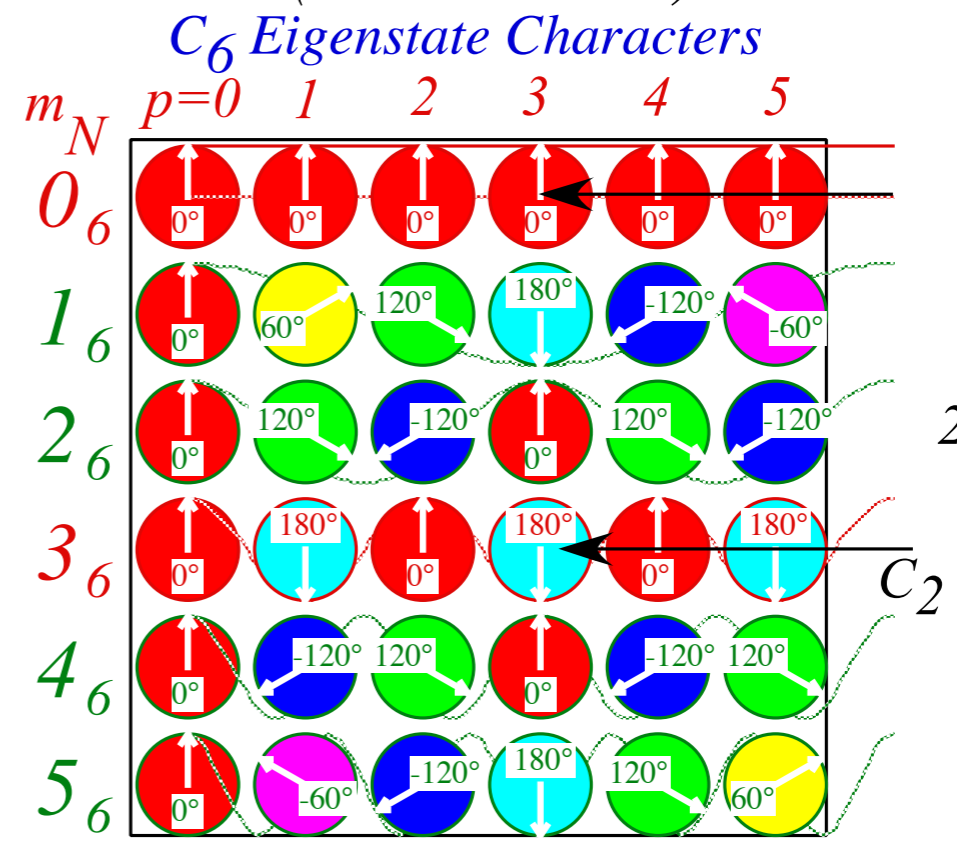
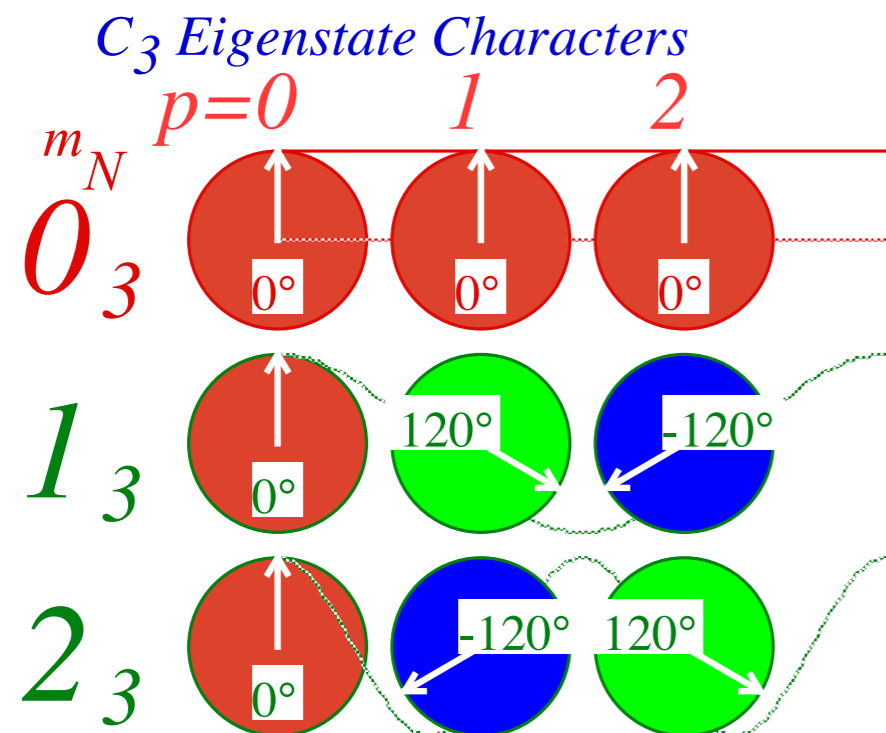

Note 2-phase AC

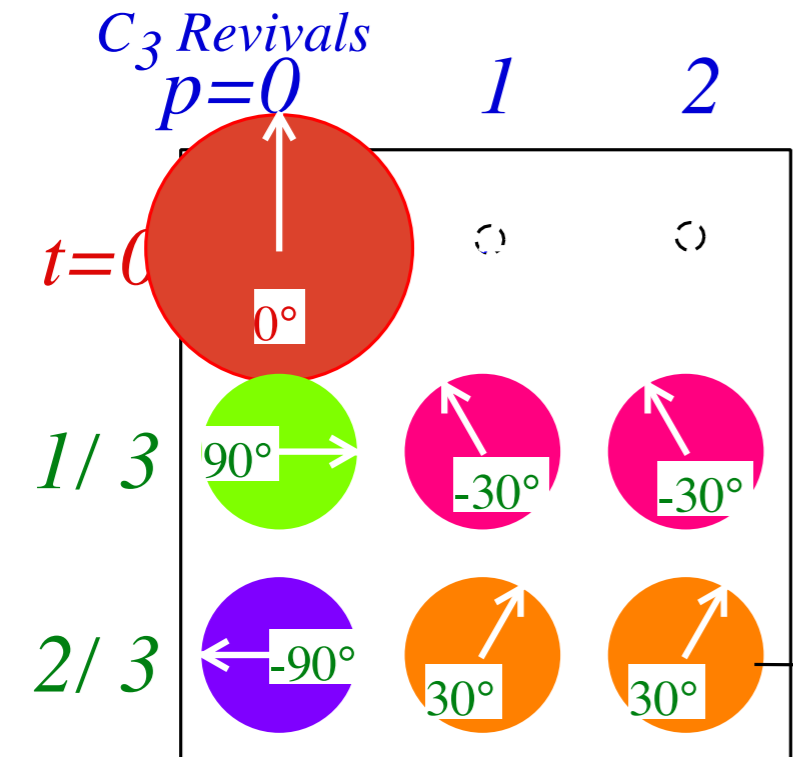

Note 3-phase sub-symmetry

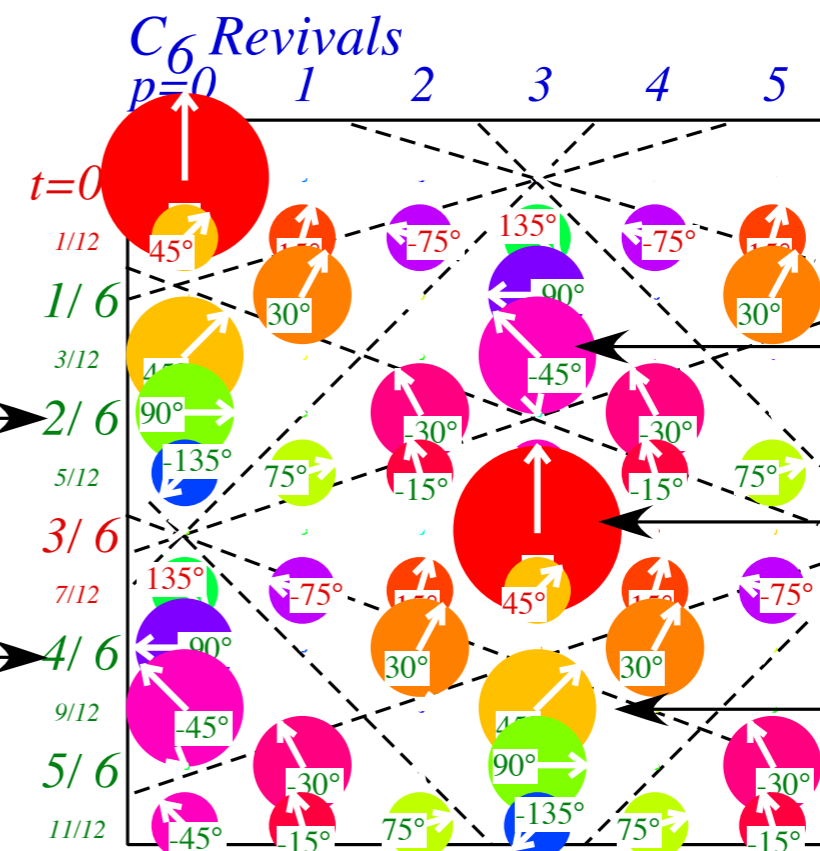

Note 2-phase sub-symmetry (The "Mother of all symmetry" is C_2)

C_m algebra of revival-phase dynamics

Quantum rotor fractional take turns at C_n symmetry

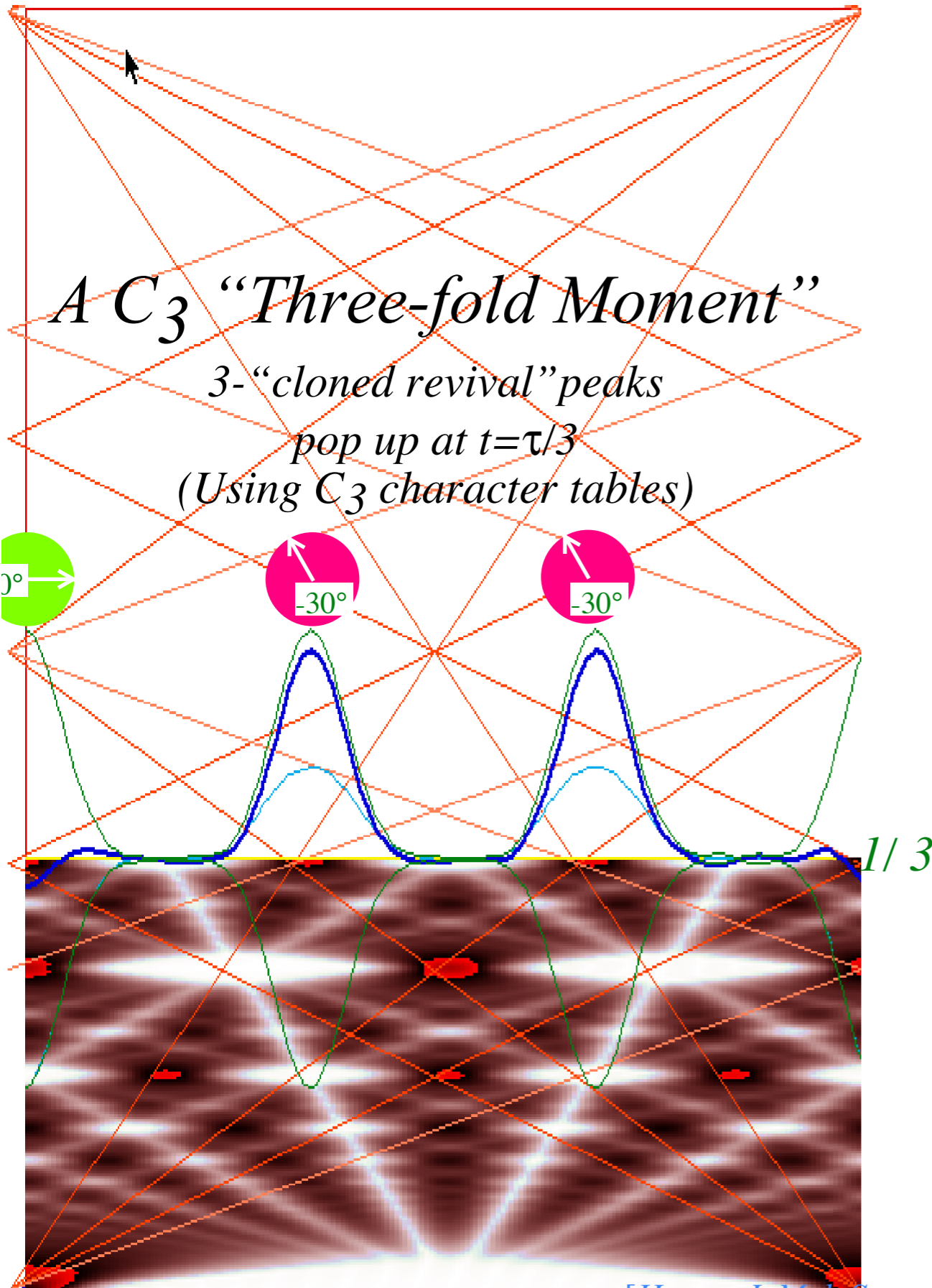

[Harter, J. Mol. Spec. 210, 166-182 (2001)]

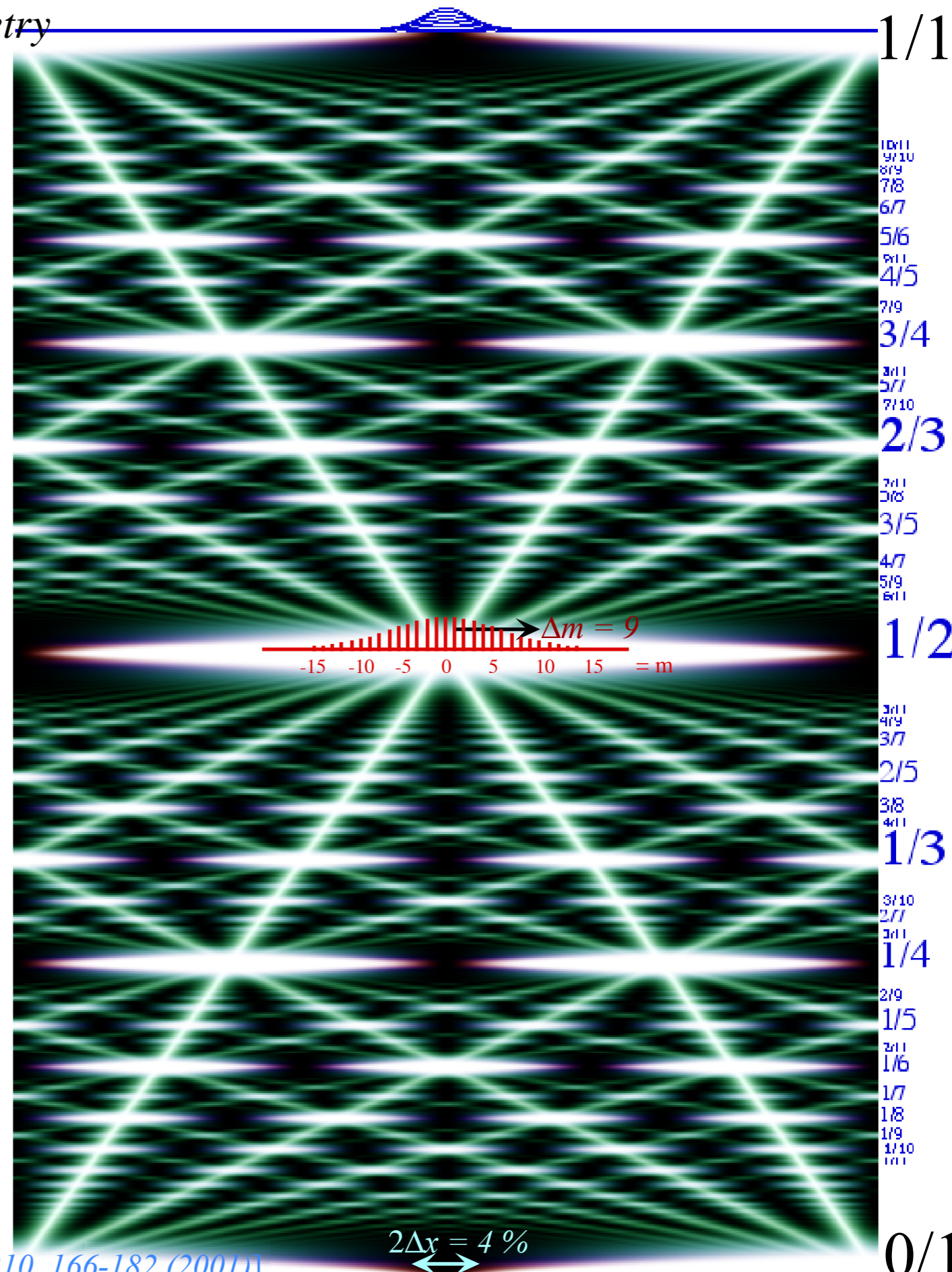

Algebra and geometry of resonant revivals: Farey Sums and Ford Circles

Time t (units of fundamental period τ_1)

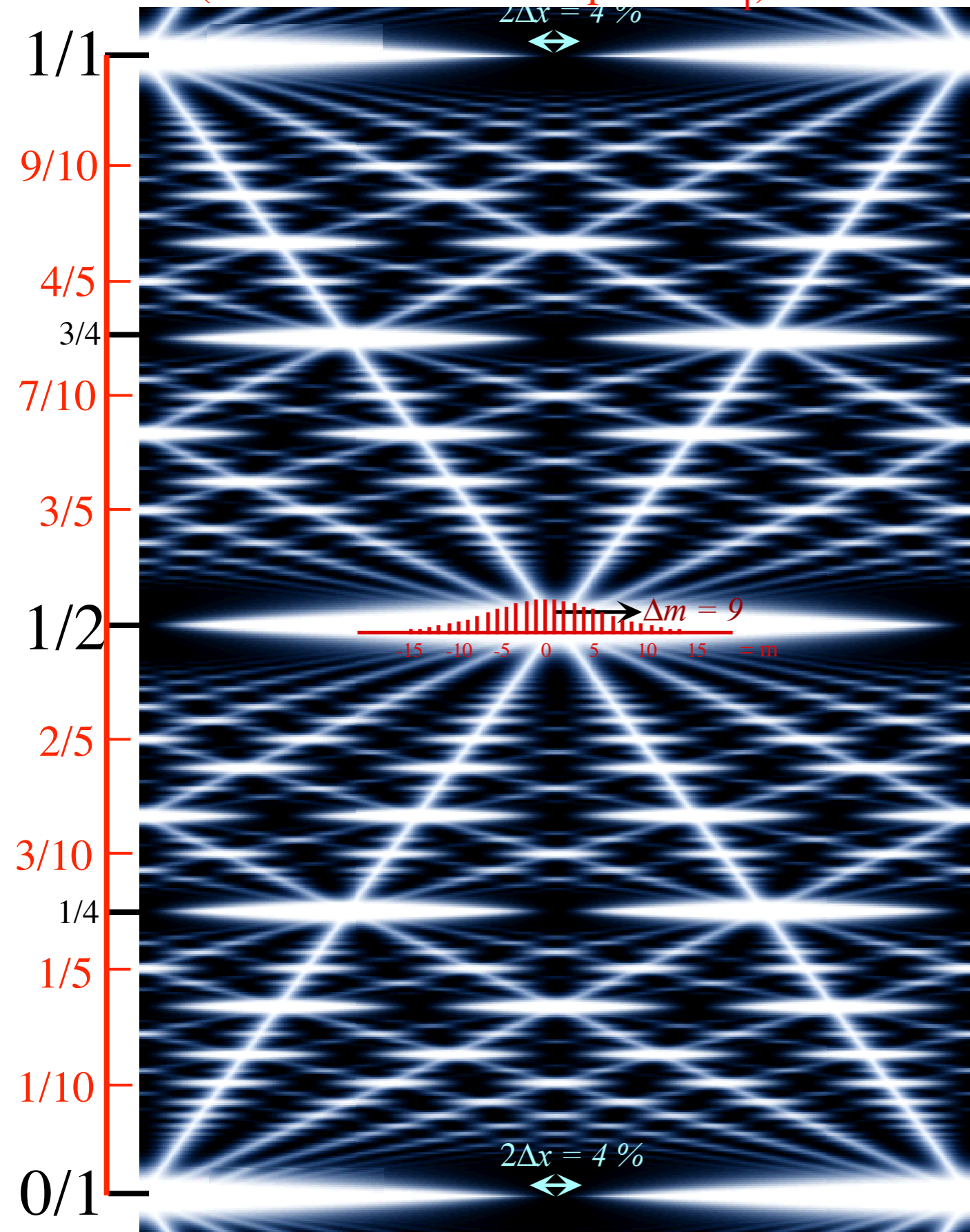

(Imagine "wrap-around" ϕ -coordinate)

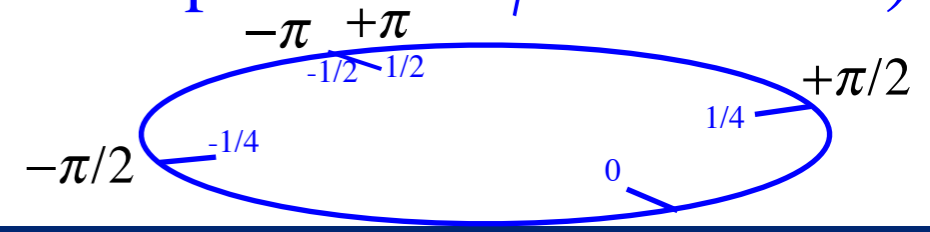

time

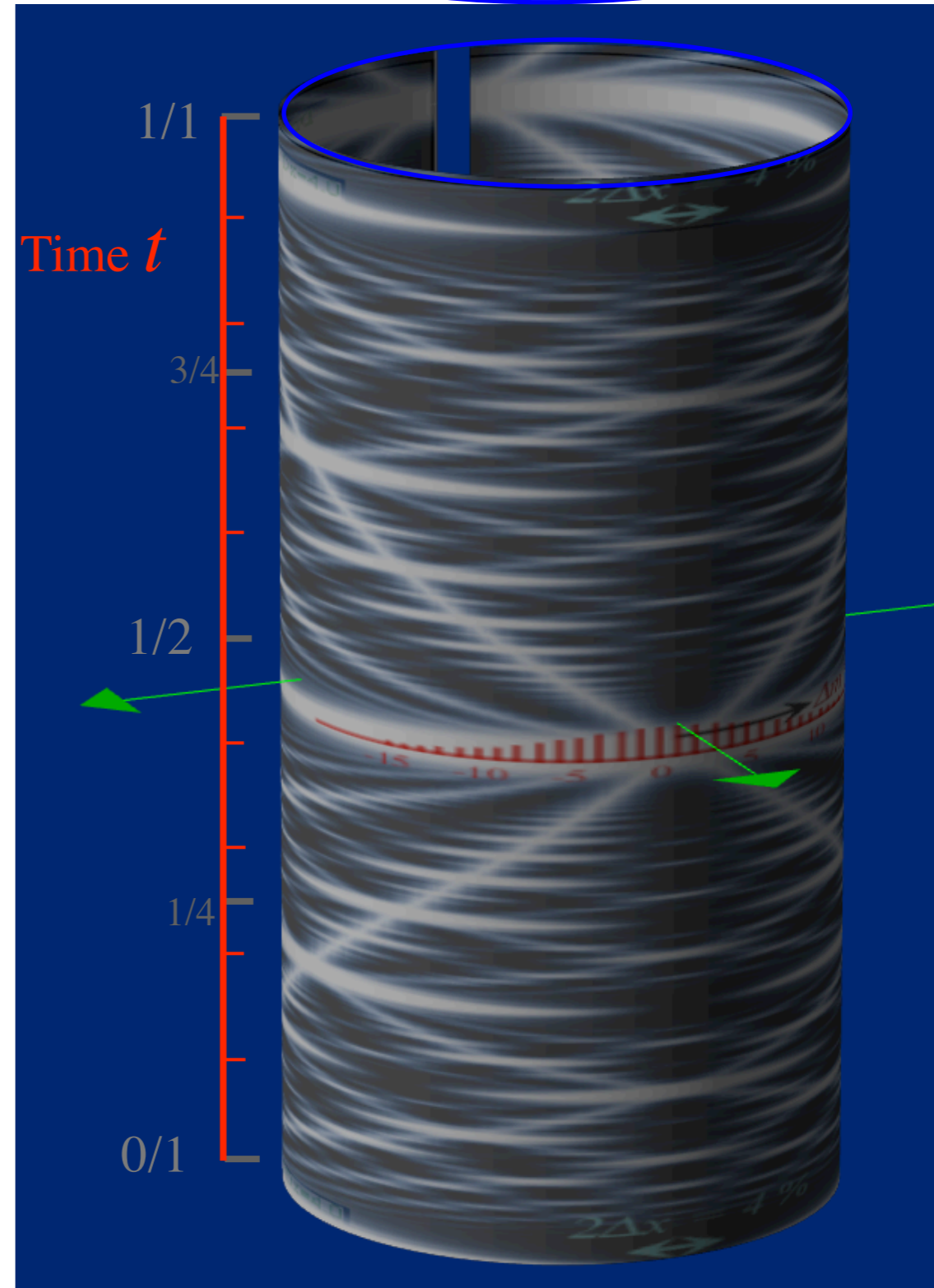

Coordinate ϕ (units of 2π)

N -level-rotor system revival-beat wave dynamics

(Just 2-levels $(0, \pm 1)$ (and some ± 2) excited)

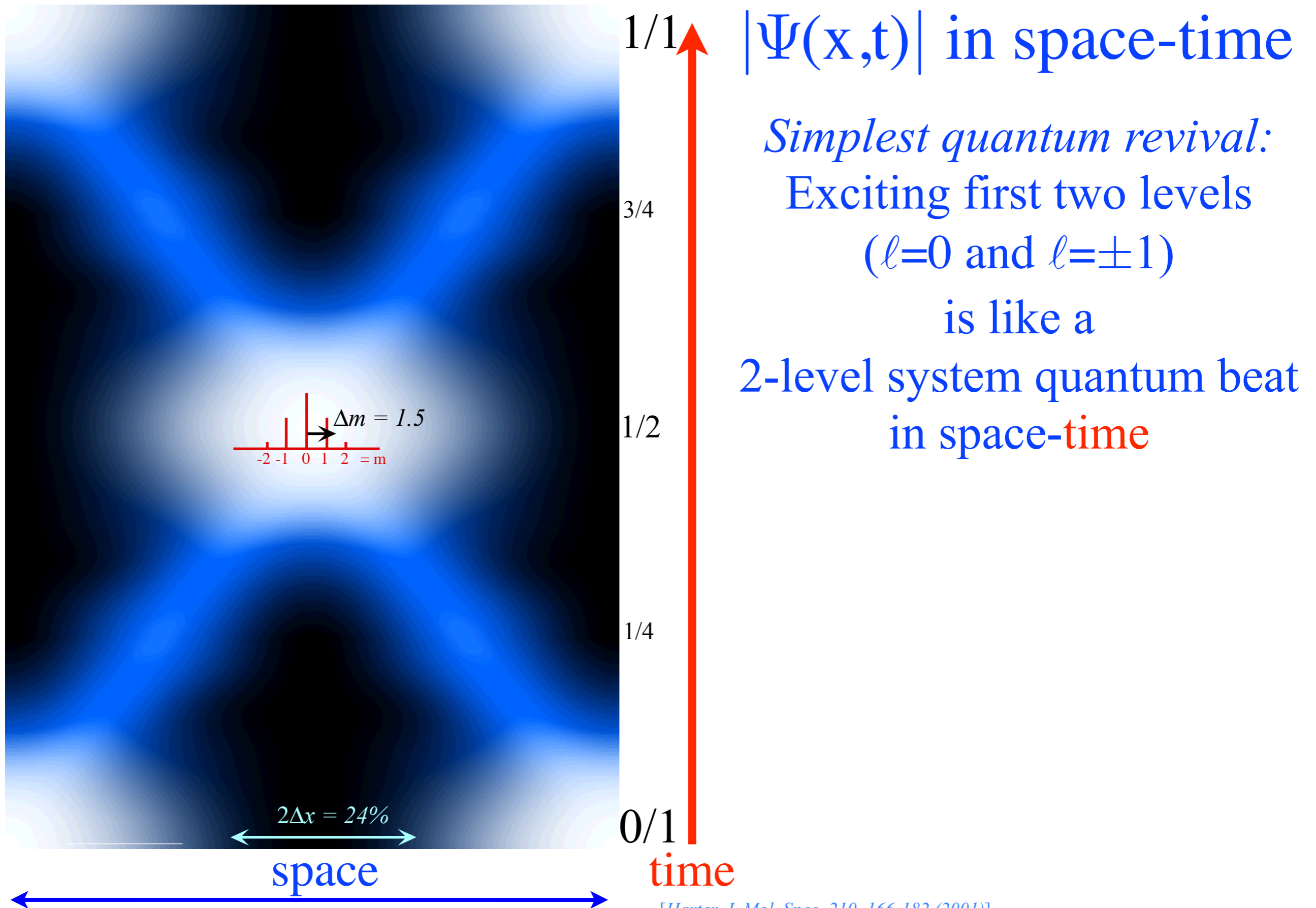

[Harter, *J. Mol. Spec.* 210, 166-182 (2001)]

N -level-rotor system revival-beat wave dynamics

(Just 2-levels $(0, \pm 1)$ (and some ± 2) excited)

(4-levels $(0, \pm 1, \pm 2, \pm 3)$ (and some ± 4) excited)

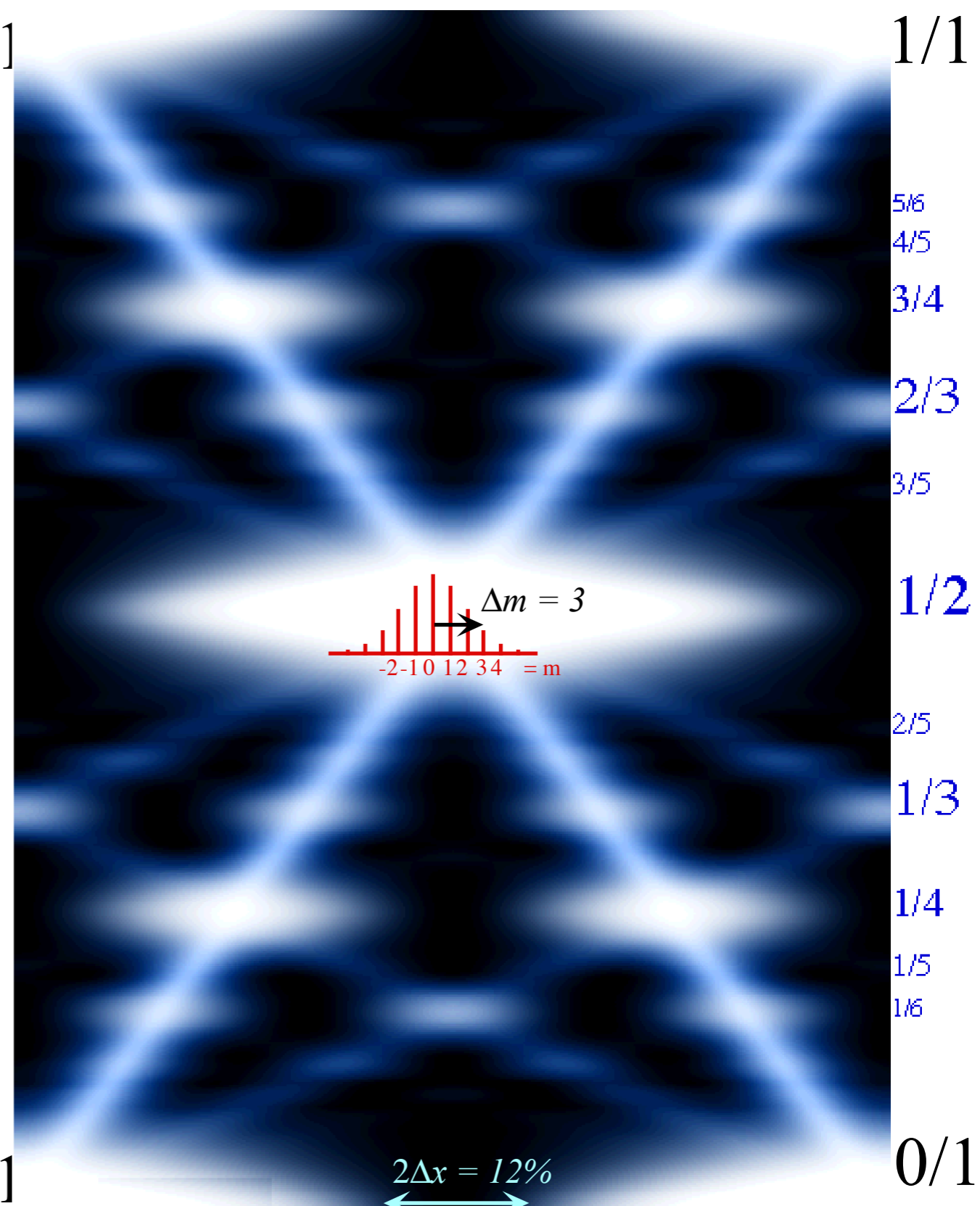
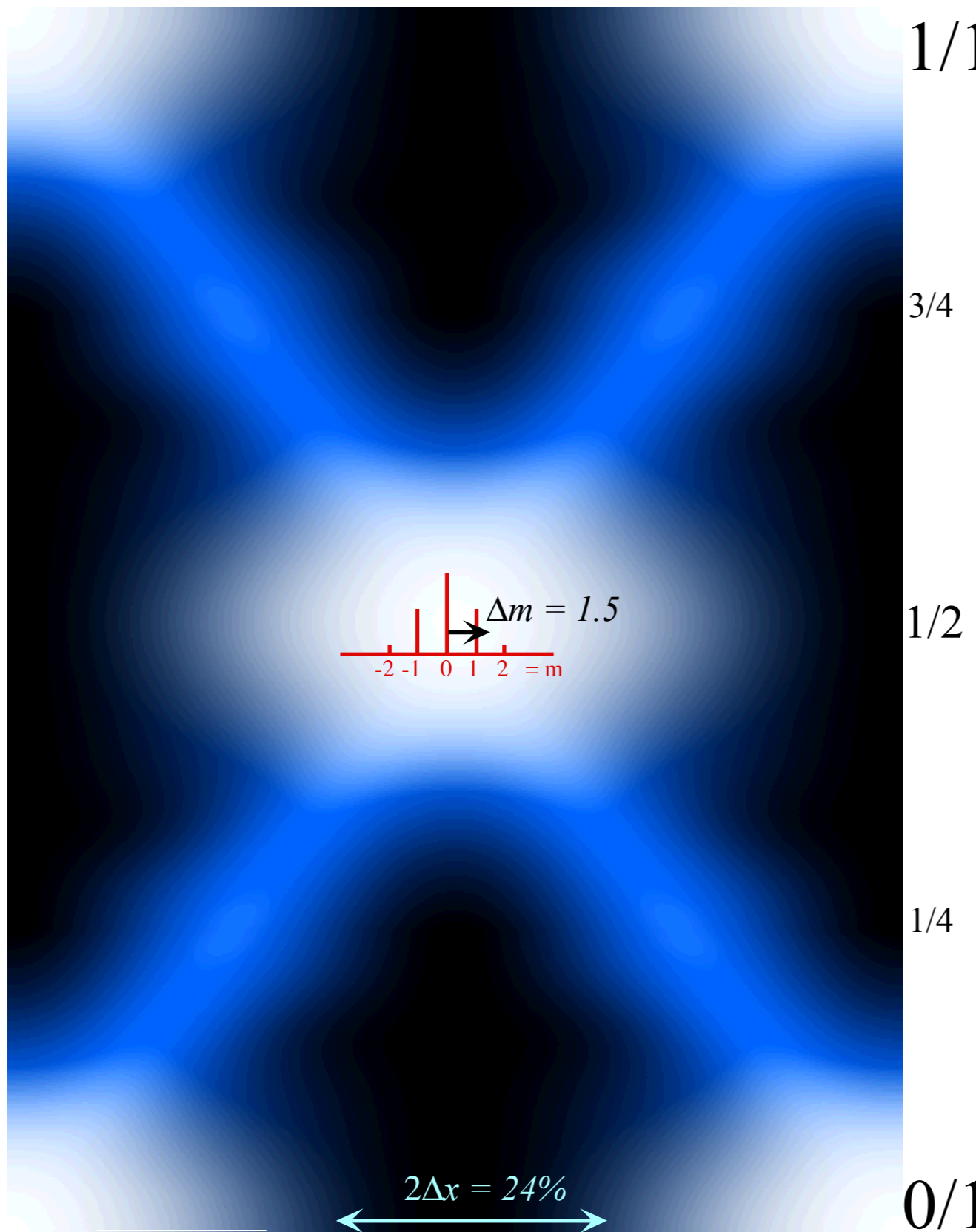

Simplest *fractional* quantum revivals: 3,4,5-level systems

N -level-rotor system revival-beat wave dynamics

(9 or 10-levels (0, ± 1 , ± 2 , ± 3 , ± 4 , ..., ± 9 , ± 10 , ± 11 ...) excited)

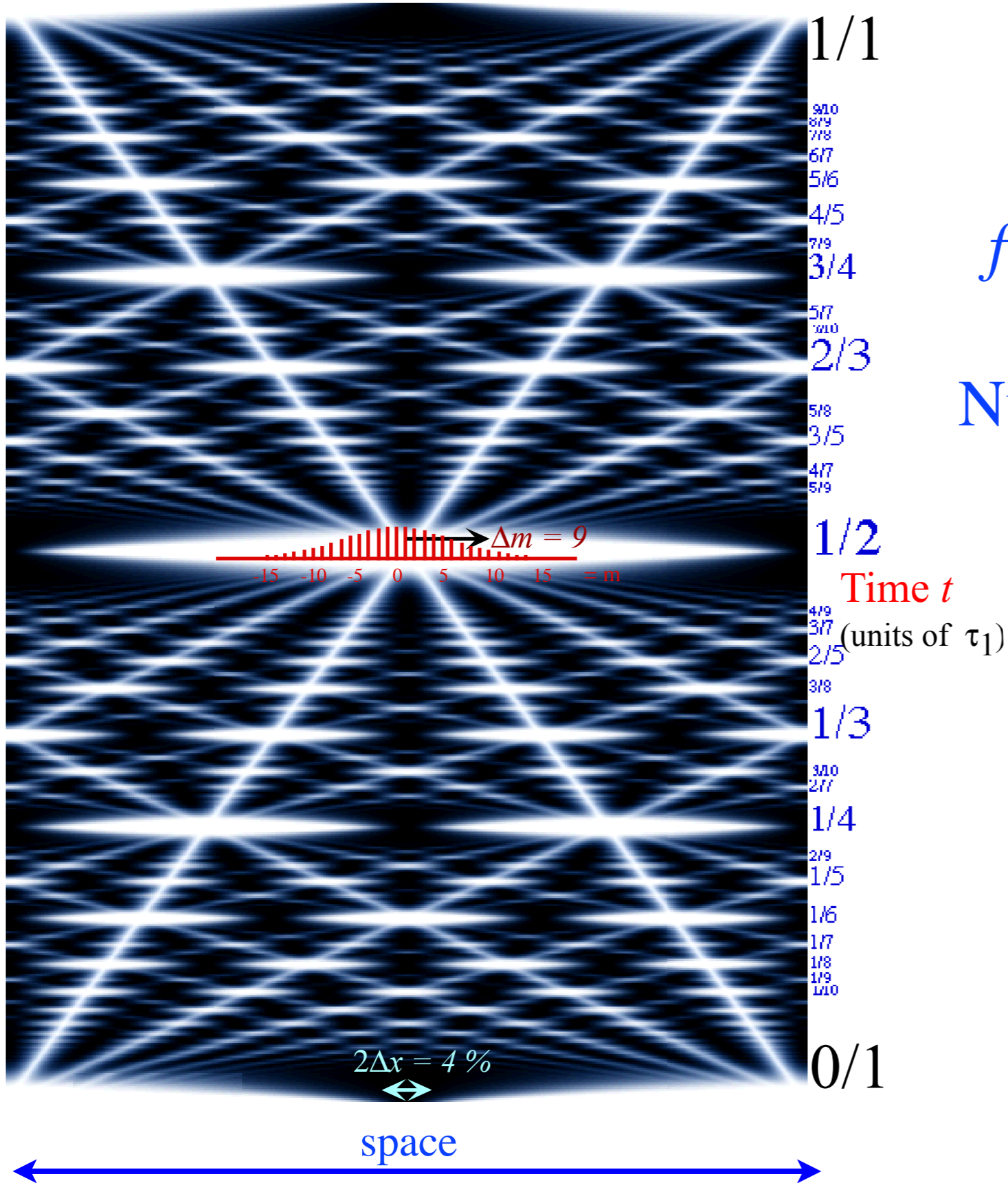

fractional quantum revivals:
in 3, 4, ..., N -level systems
Number increases rapidly with
number of levels
and/or bandwidth
of excitation

[Harter, *J. Mol. Spec.* 210, 166-182 (2001)]

N -level-rotor system revival-beat wave dynamics

(9 or 10-levels $(0, \pm 1, \pm 2, \pm 3, \pm 4, \dots, \pm 9, \pm 10, \pm 11, \dots)$ excited)

Zeros (clearly) and "particle-packets" (faintly) have paths labeled by fraction sequences like: $\frac{0}{7}, \frac{1}{7}, \frac{2}{7}, \frac{3}{7}, \frac{4}{7}, \frac{5}{7}, \frac{6}{7}, \frac{1}{1}$

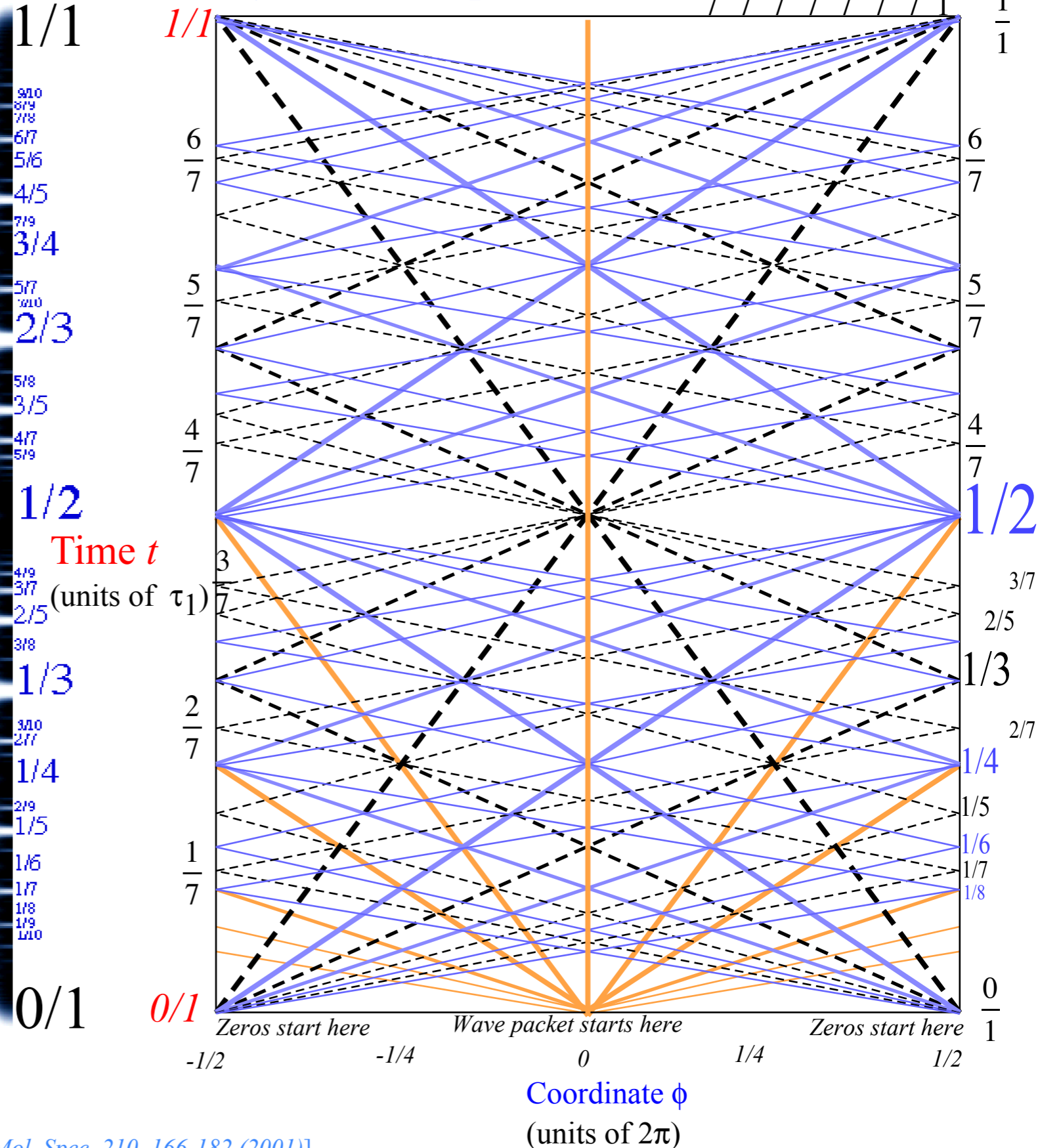
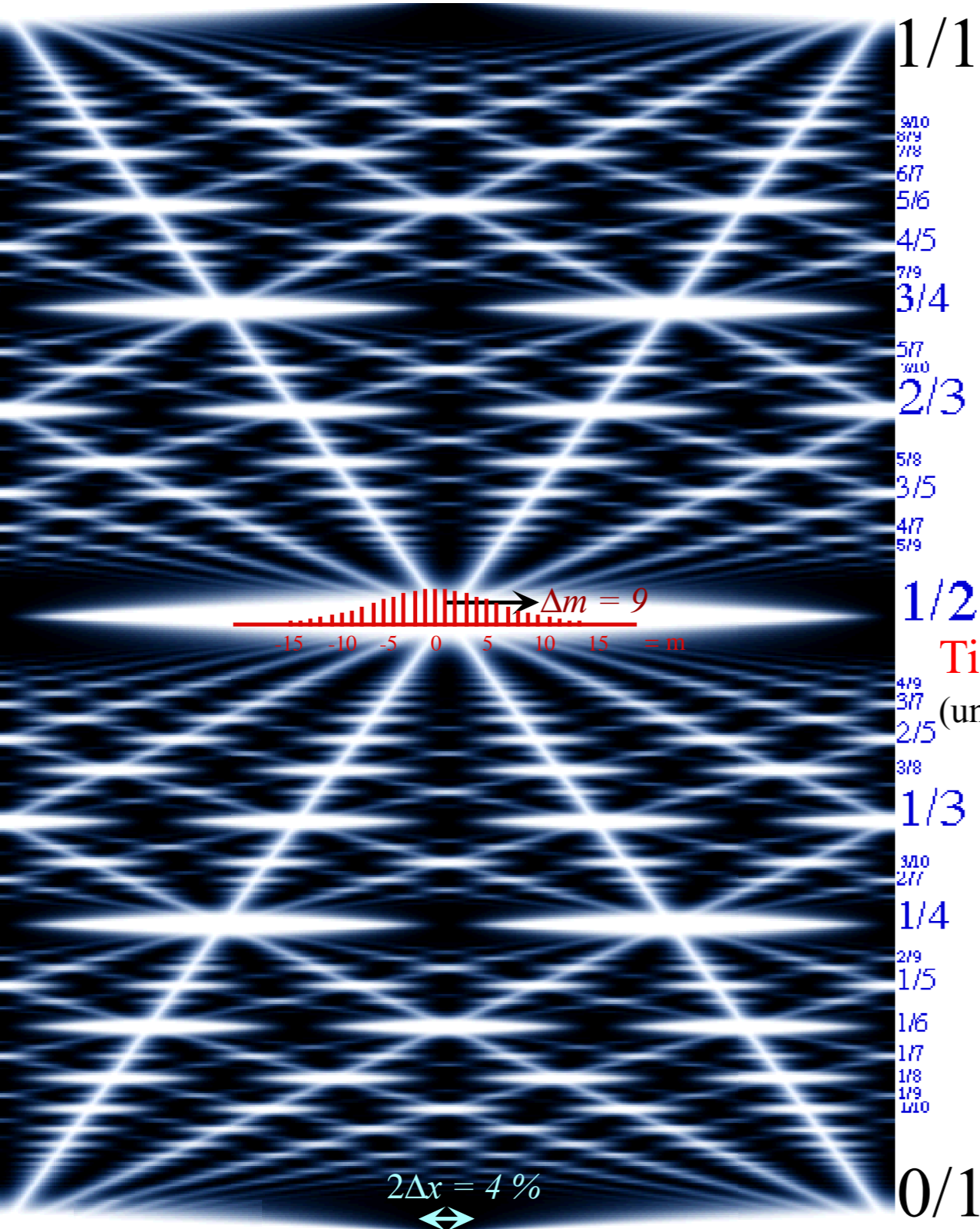

[Harter, *J. Mol. Spec.* 210, 166-182 (2001)]

(a) Big ball moves in and traps small ball between it and The Wall

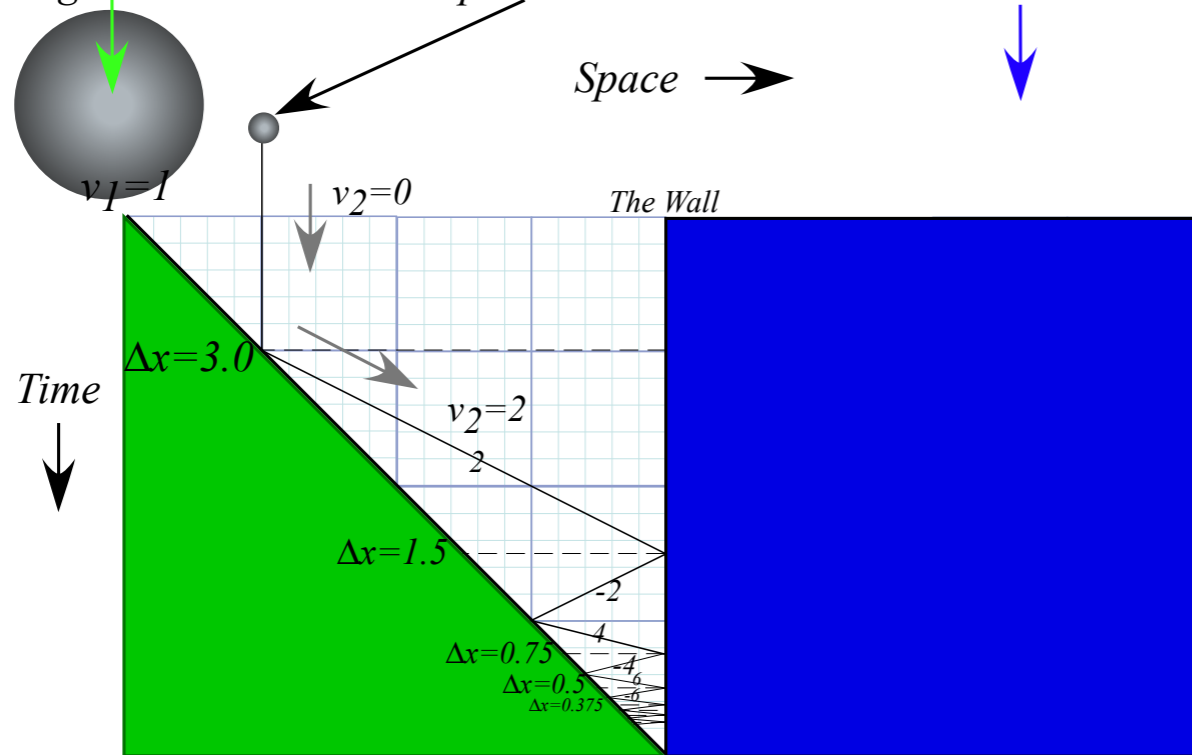

Lect. 5 (9.11.14)

The Classical “Monster Mash”

Classical introduction to

Heisenberg “Uncertainty” Relations

$$v_2 = \frac{\text{const.}}{Y} \quad \text{or:} \quad Y \cdot v_2 = \text{const.}$$

is analogous to: $\Delta x \cdot \Delta p = N \cdot \hbar$

Recall classical “Monster Mash” in Lecture 5

with small-ball trajectory paths having same geometry
as revival beat wave-zero paths

Farey-Sum arithmetic of revival wave-zero paths
(How Rational Fractions N/D occupy real space-time)

Farey Sum algebra of revival-beat wave dynamics

Label by *numerators* N and *denominators* D of rational fractions N/D

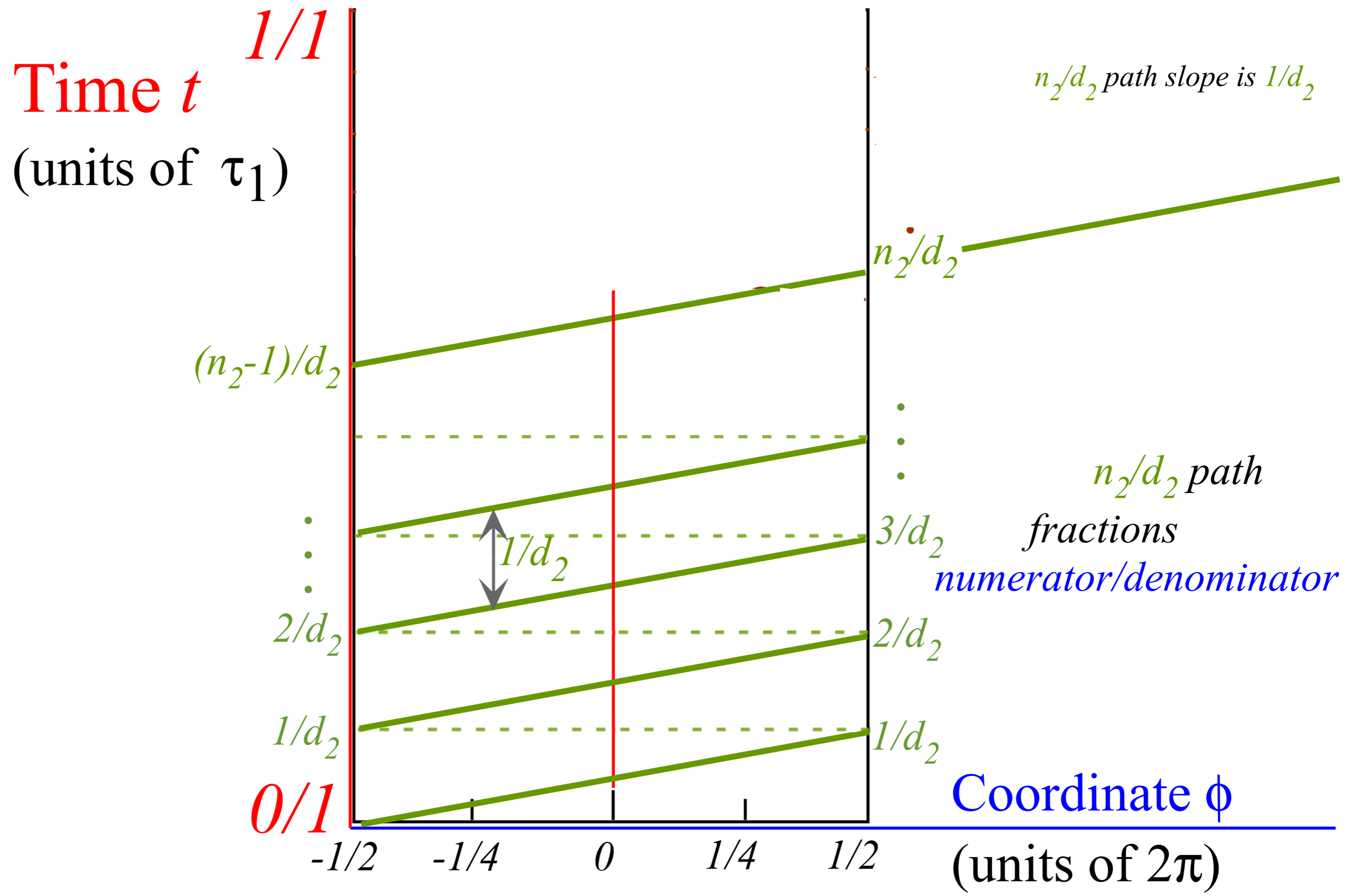

Harter, *J. Mol. Spec.* 210, 166-182 (2001) and *ISMS* (2013)

Farey Sum algebra of revival-beat wave dynamics

Label by numerators N and denominators D of rational fractions N/D

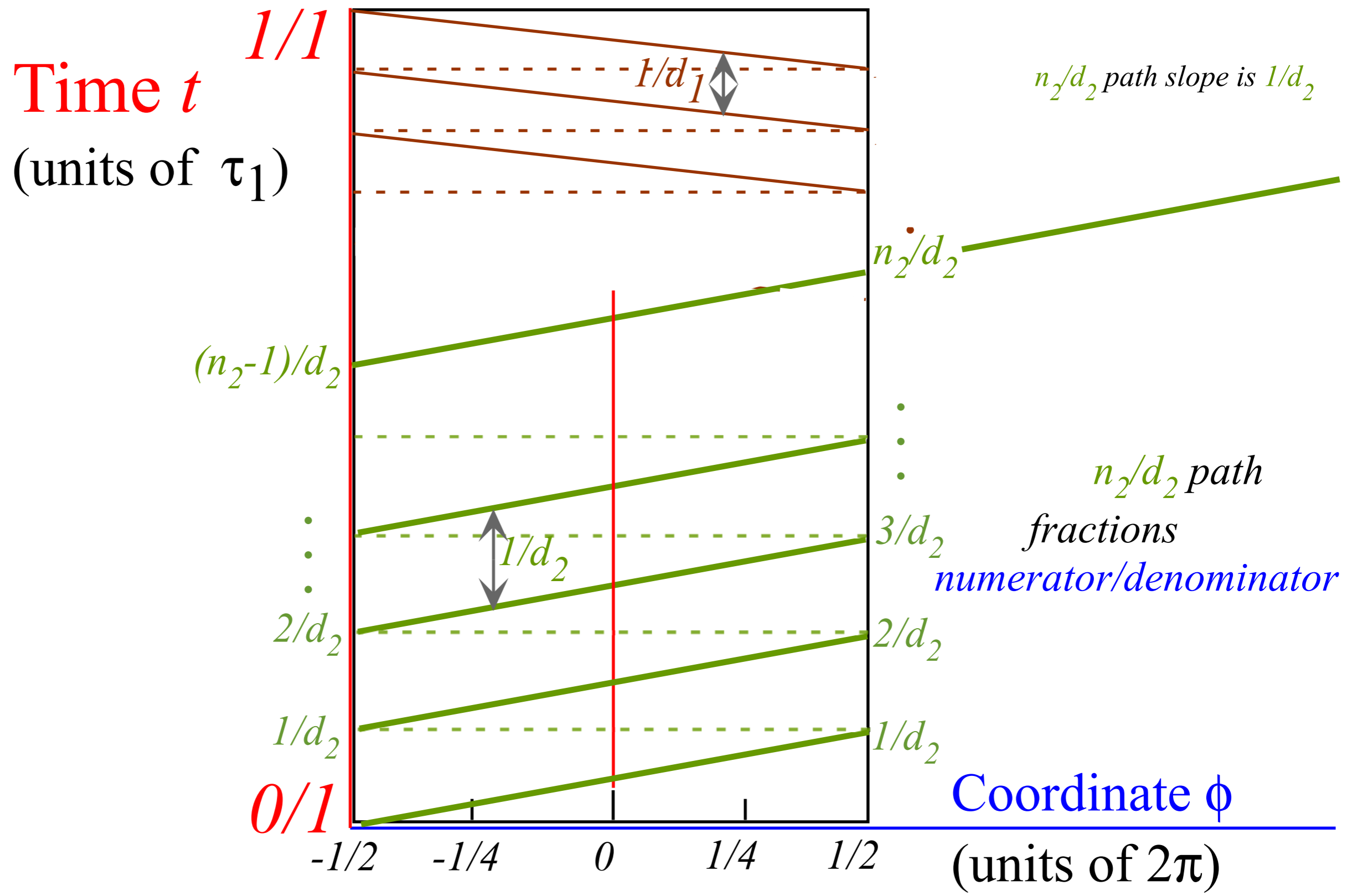

Harter, J. Mol. Spec. 210, 166-182 (2001) and ISMS (2013)

Farey Sum algebra of revival-beat wave dynamics

Label by numerators N and denominators D of rational fractions N/D

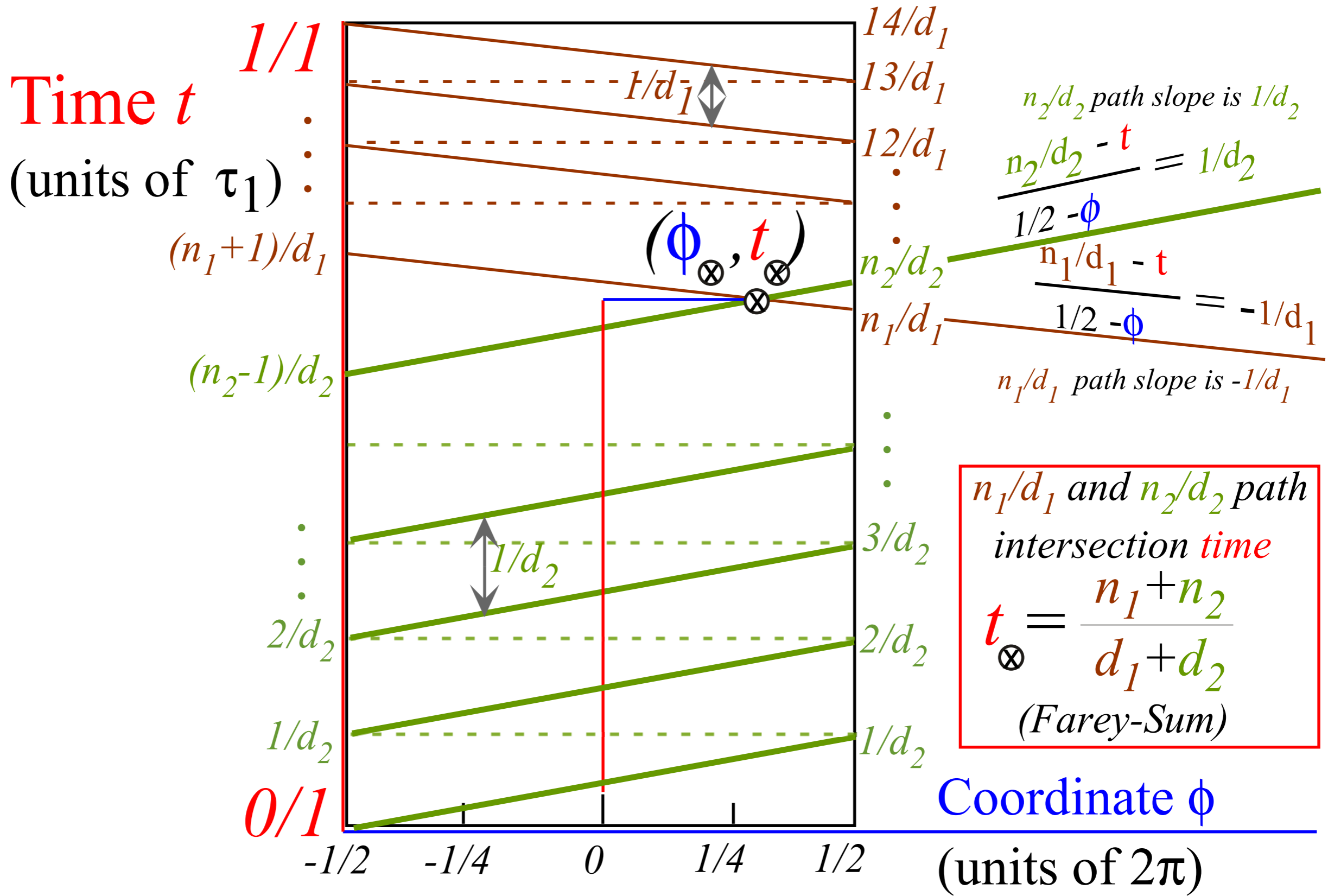

Harter, J. Mol. Spec. 210, 166-182 (2001) and ISMS (2013)

[John Farey, Phil. Mag.(1816)]

Farey Sum algebra of revival-beat wave dynamics

Label by numerators N and denominators D of rational fractions N/D

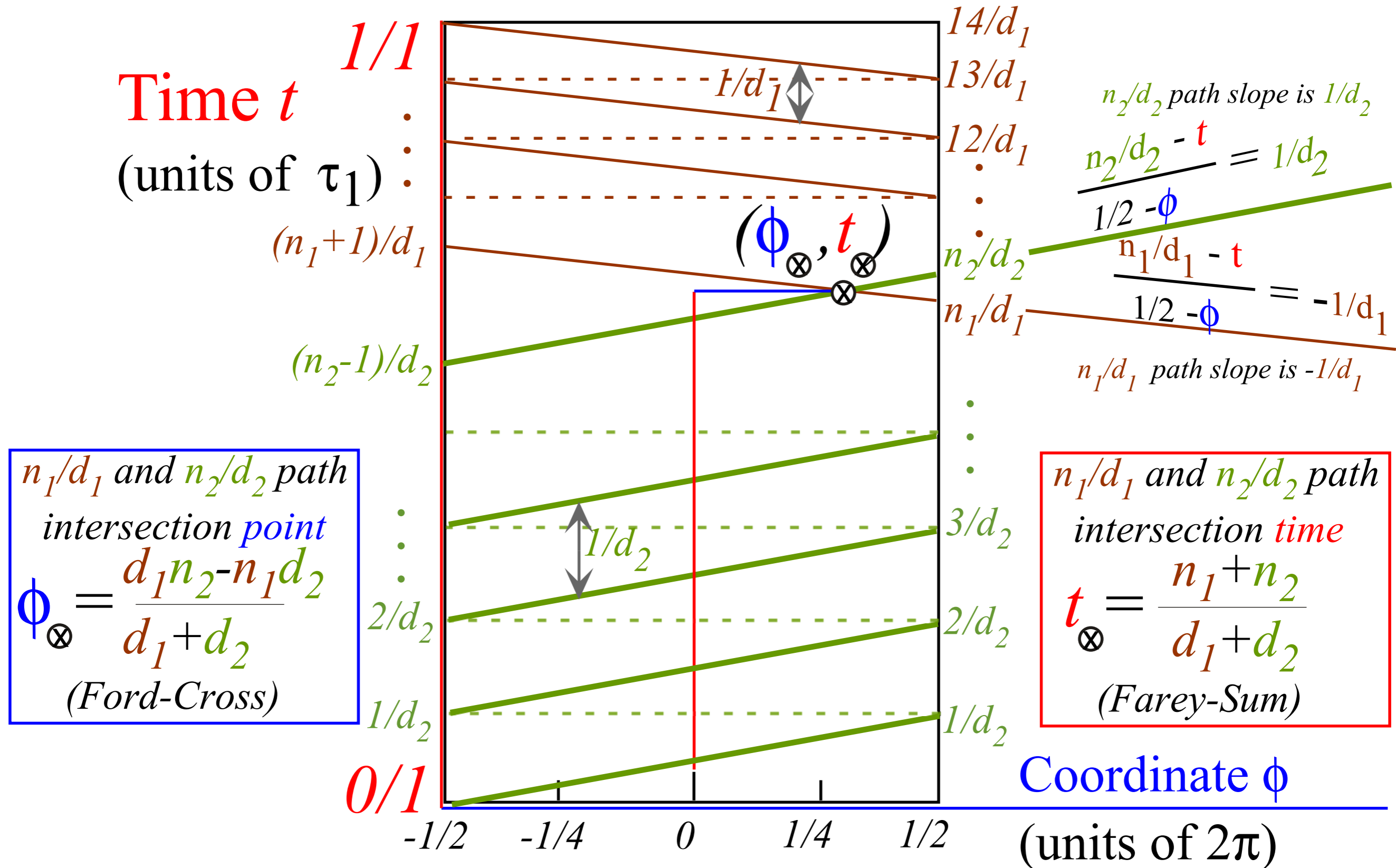

[Lester. R. Ford, Am. Math. Monthly 45,586(1938)]

Harter, J. Mol. Spec. 210, 166-182 (2001) and ISMS (2013)

[John Farey, Phil. Mag.(1816)]

Ford-Circle geometry of revival paths
(How *Rational Fractions* N/D occupy real space-time)

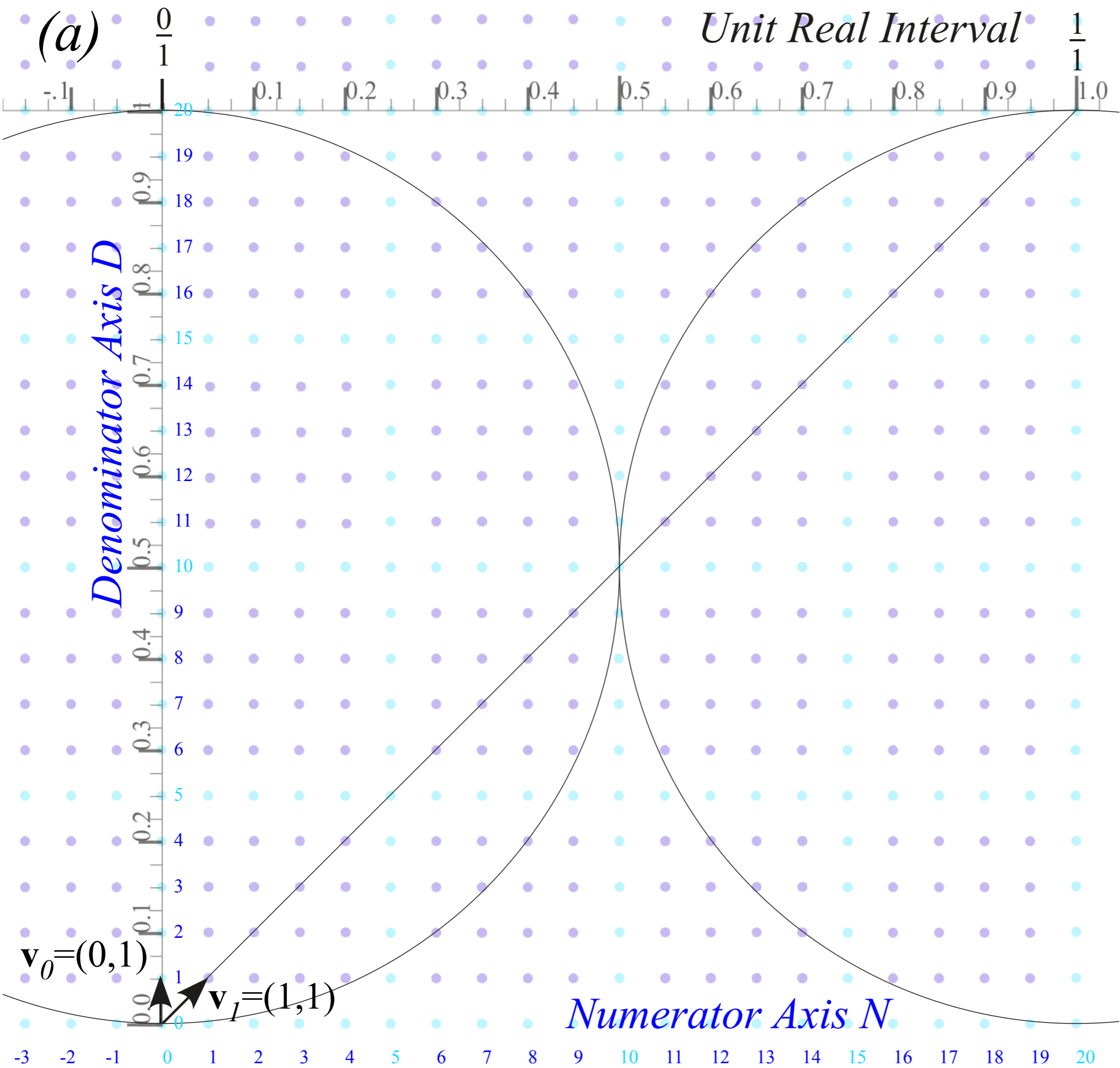

Farey Sum
 related to
 vector sum
 and
Ford Circles
 1/1-circle has
 diameter 1

A. Li and W. Harter,
 Chem. Phys. Letters,
 633, 208-213 (2015)

Harter and Alvason Li
 Int. Symposium on
 Molecular Spectroscopy
 OSU Columbus (2013)

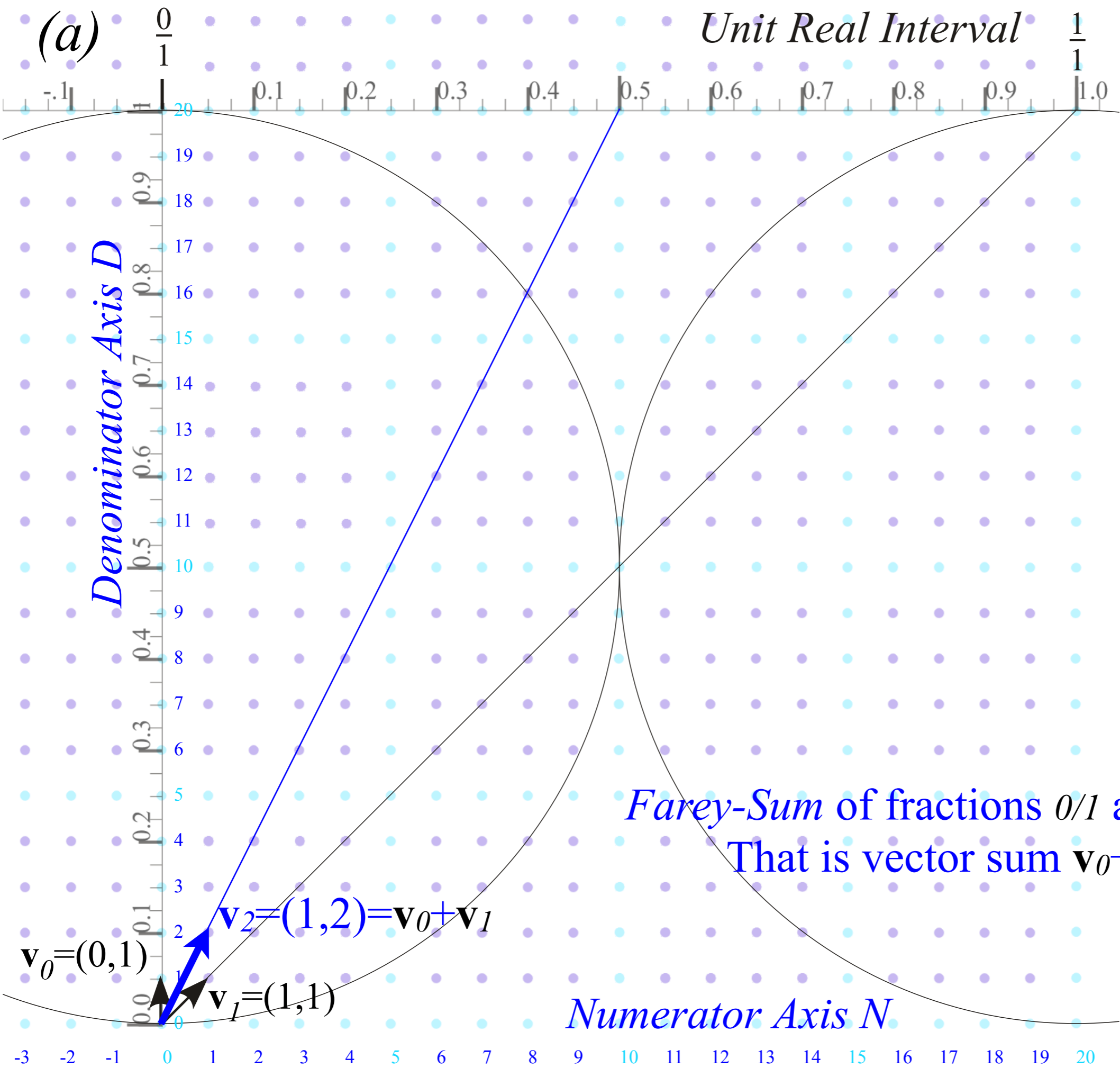

Farey Sum
 related to
 vector sum
 and
Ford Circles
 1/1-circle has
 diameter 1

Farey-Sum of fractions $0/1$ and $1/1$ is $1/2$
 That is vector sum $\mathbf{v}_0 + \mathbf{v}_1 = (1, 2) = \mathbf{v}_2$

A. Li and W. Harter,
 Chem. Phys. Letters,
 633, 208-213 (2015)

Harter and Alvason Li
 Int. Symposium on
 Molecular Spectroscopy
 OSU Columbus (2013)

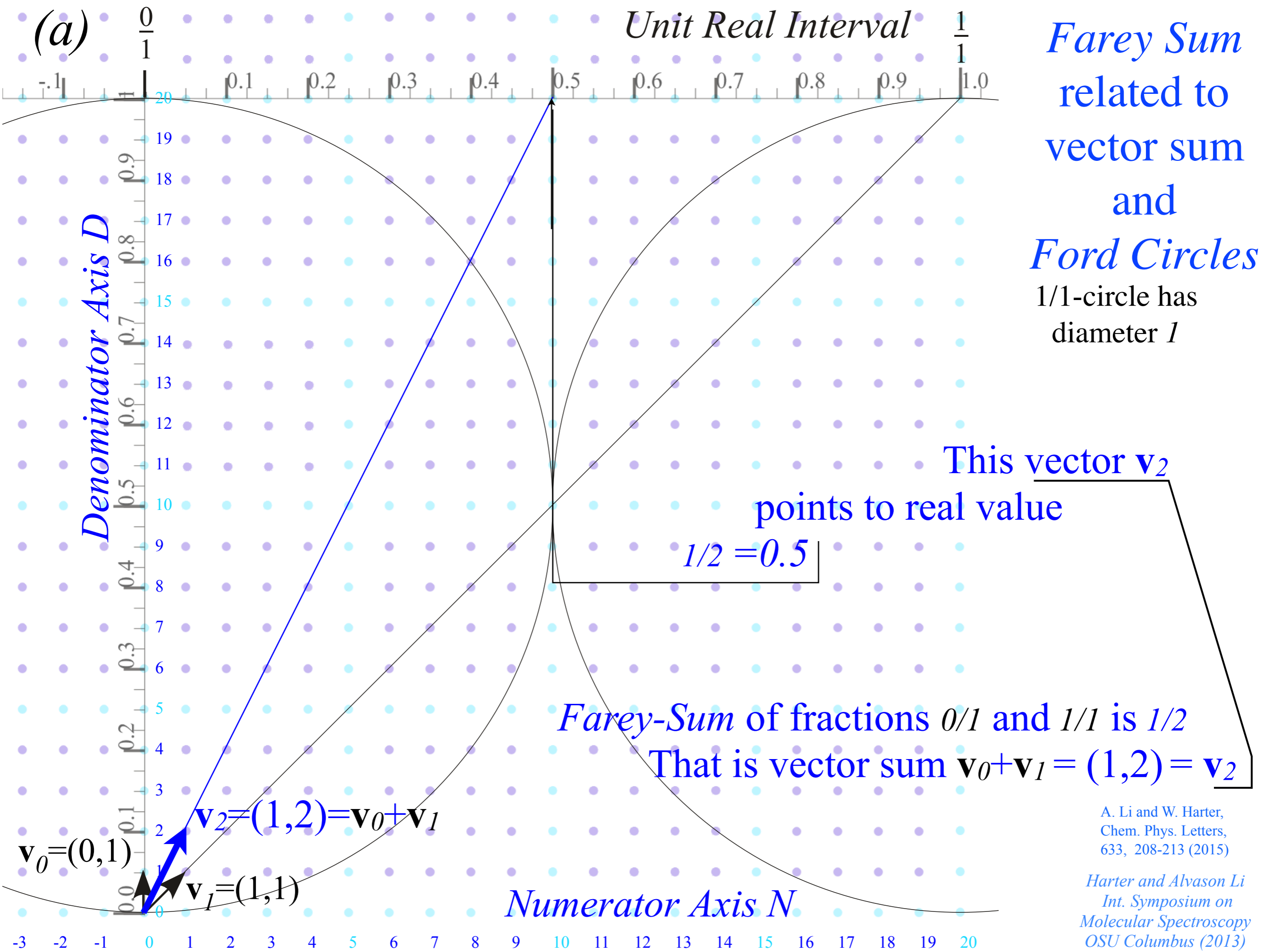

(a)

Unit Real Interval

Farey Sum
related to
vector sum
and
Ford Circles

1/1-circle has
diameter 1

Denominator Axis D

This vector \mathbf{v}_2

points to real value

$1/2 = 0.5$

Farey-Sum of fractions $0/1$ and $1/1$ is $1/2$

That is vector sum $\mathbf{v}_0 + \mathbf{v}_1 = (1,2) = \mathbf{v}_2$

Numerator Axis N

A. Li and W. Harter,
Chem. Phys. Letters,
633, 208-213 (2015)

Harter and Alvason Li
Int. Symposium on
Molecular Spectroscopy
OSU Columbus (2013)

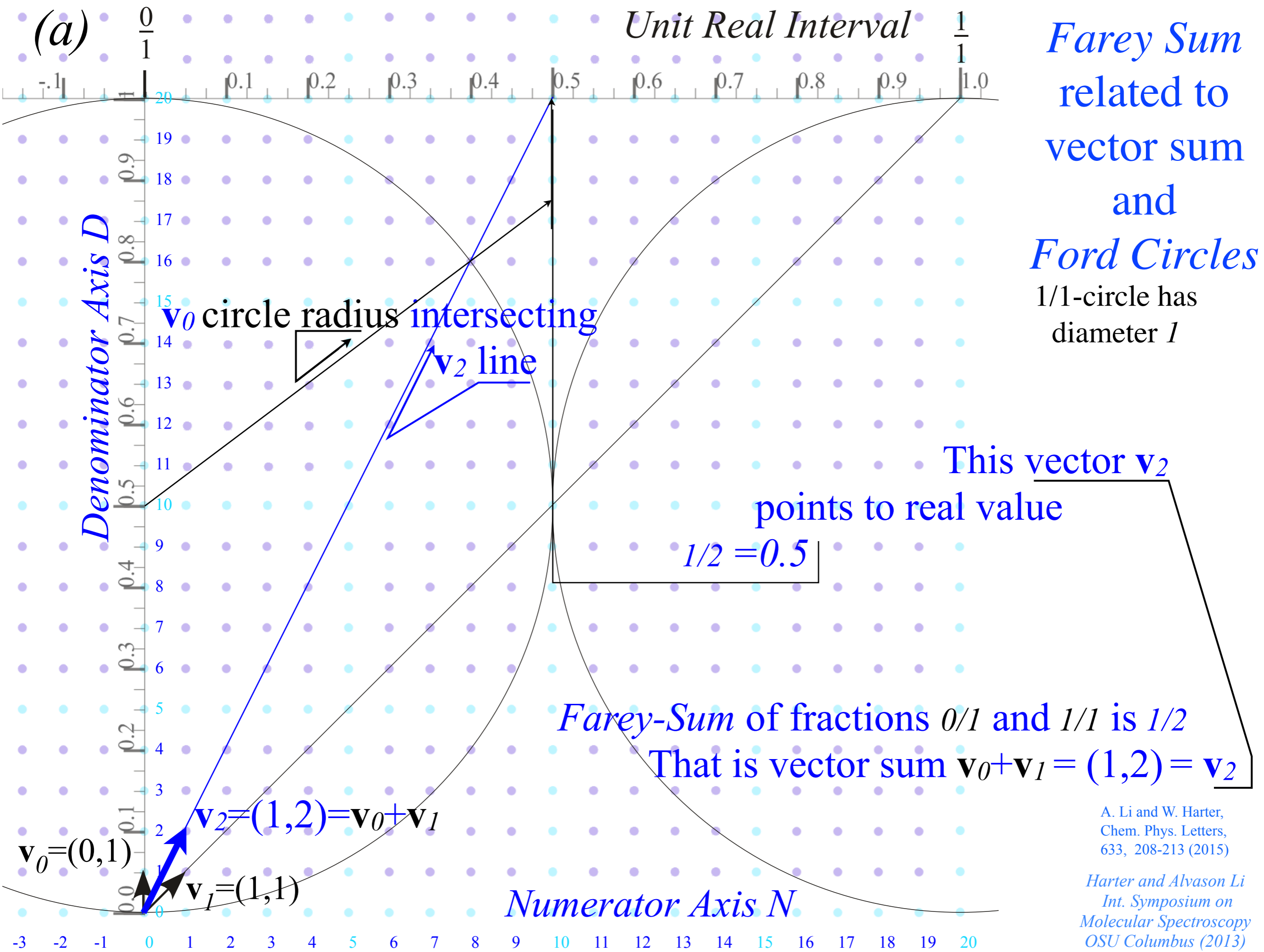

A. Li and W. Harter,
 Chem. Phys. Letters,
 633, 208-213 (2015)

Harter and Alvason Li
 Int. Symposium on
 Molecular Spectroscopy
 OSU Columbus (2013)

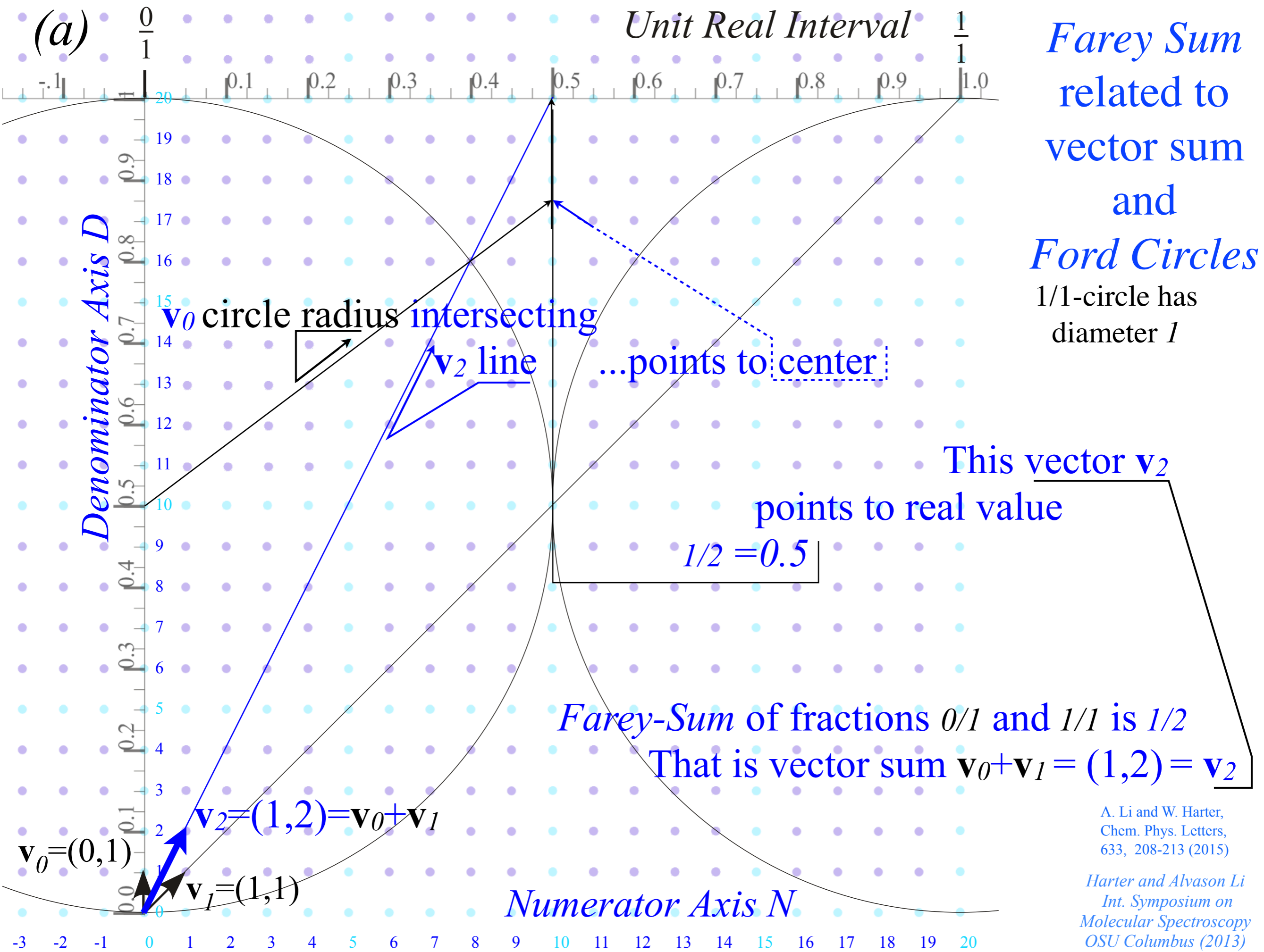

A. Li and W. Harter,
Chem. Phys. Letters,
633, 208-213 (2015)

Harter and Alvason Li
Int. Symposium on
Molecular Spectroscopy
OSU Columbus (2013)

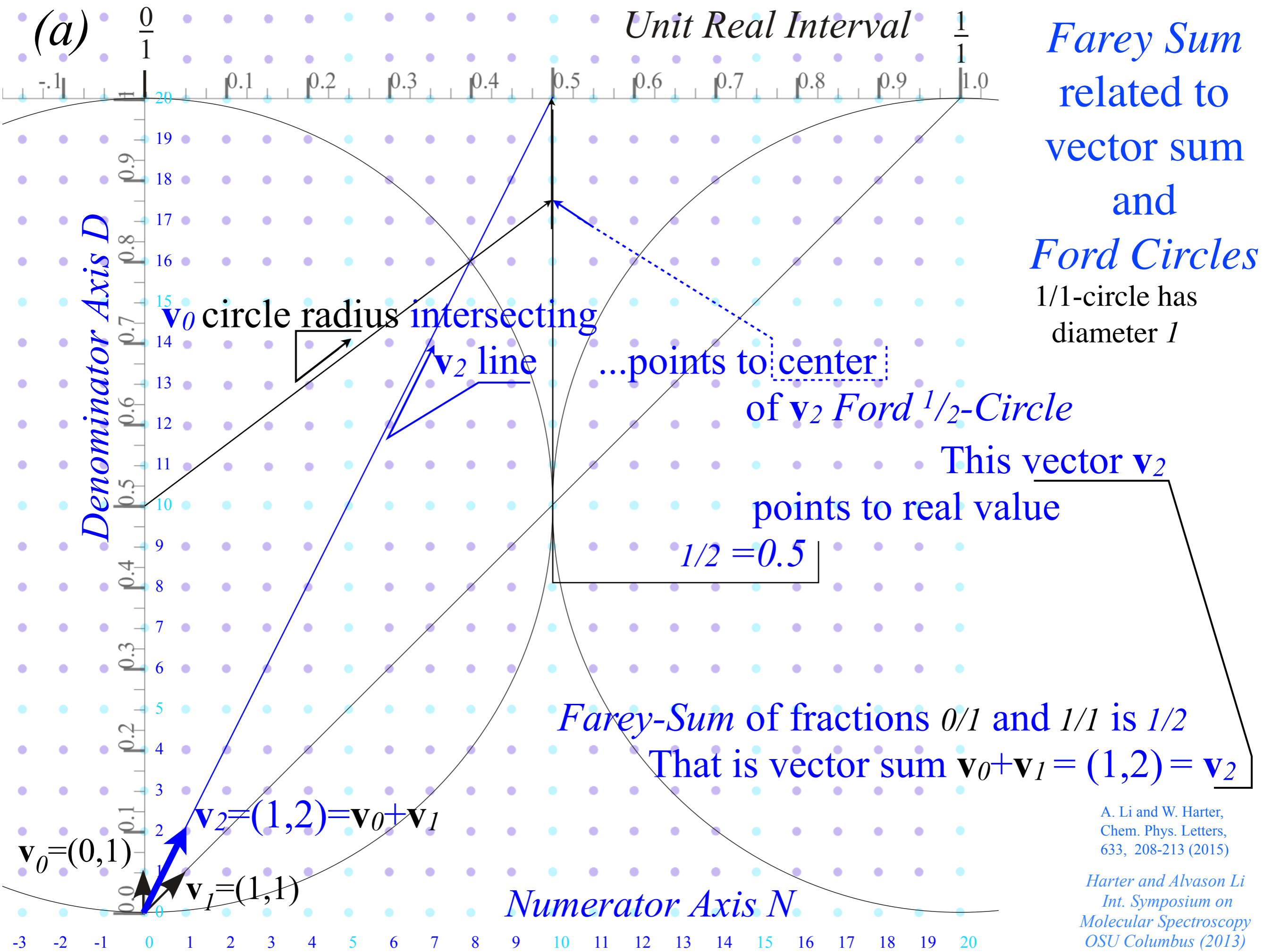

A. Li and W. Harter,
 Chem. Phys. Letters,
 633, 208-213 (2015)

Harter and Alvason Li
 Int. Symposium on
 Molecular Spectroscopy
 OSU Columbus (2013)

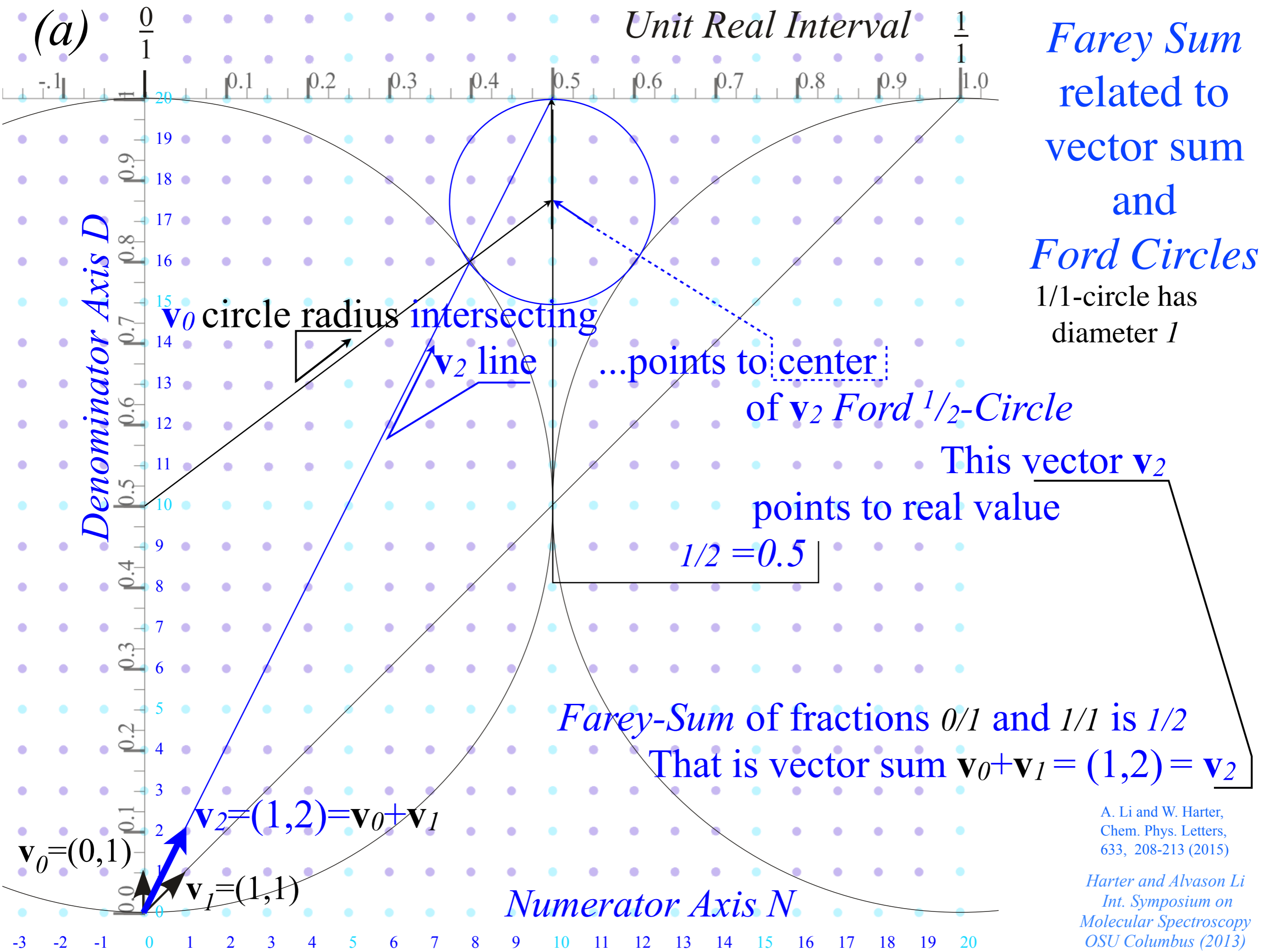

A. Li and W. Harter,
Chem. Phys. Letters,
633, 208-213 (2015)

Harter and Alvason Li
Int. Symposium on
Molecular Spectroscopy
OSU Columbus (2013)

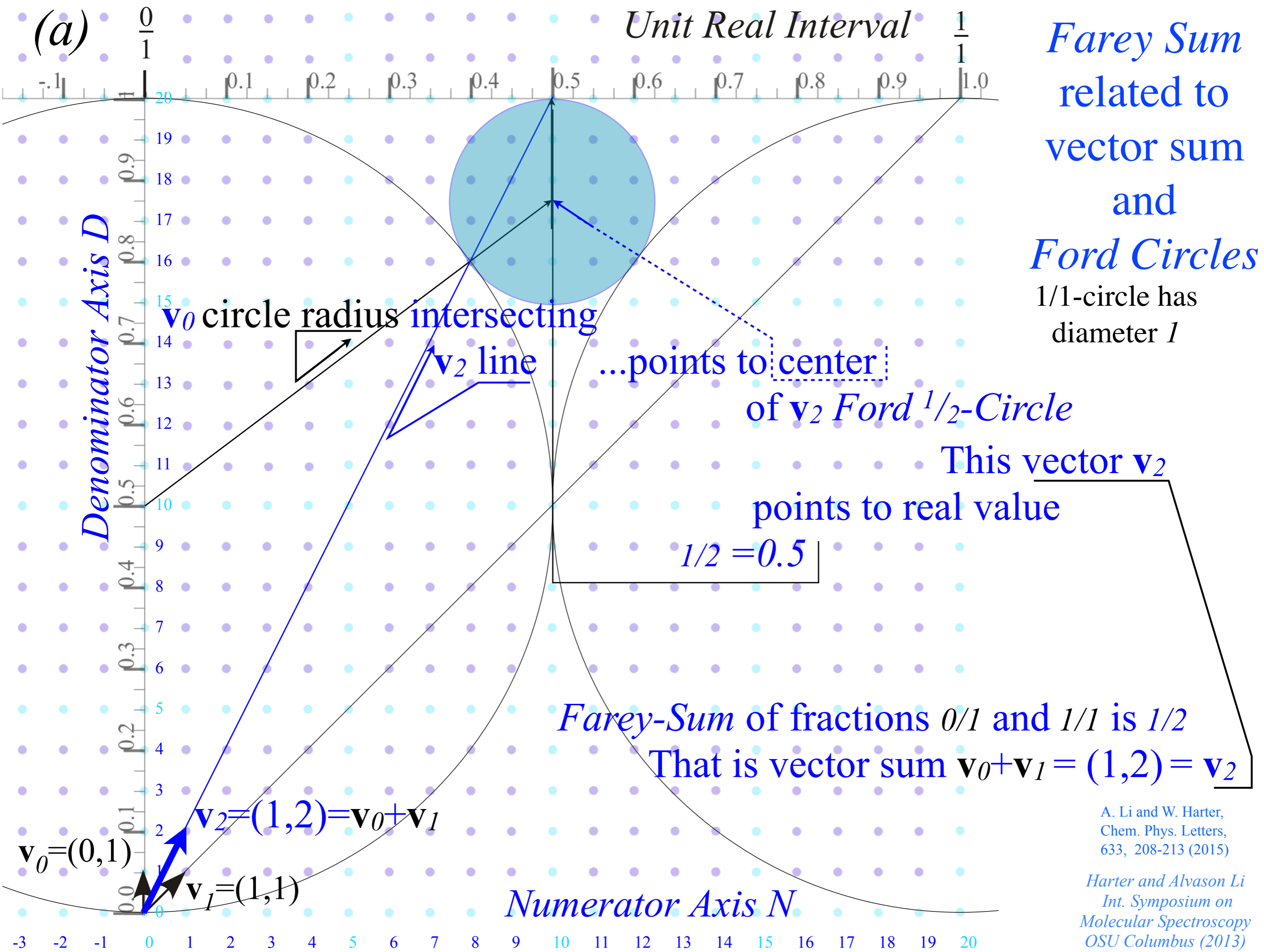

A. Li and W. Harter,
Chem. Phys. Letters,
633, 208-213 (2015)

Harter and Alvason Li
Int. Symposium on
Molecular Spectroscopy
OSU Columbus (2013)

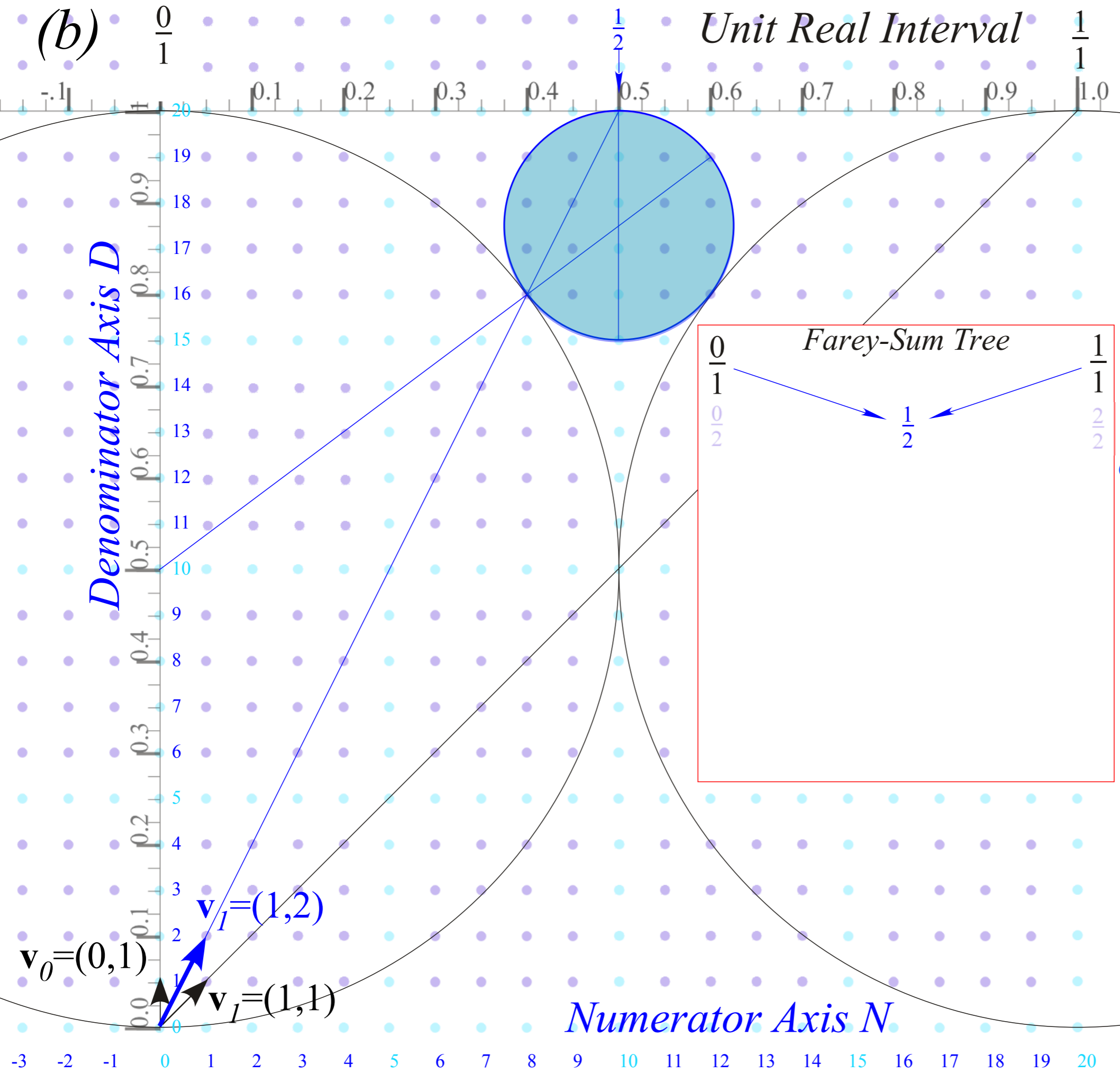

Farey Sum
related to
vector sum
and
Ford Circles

1/1-circle has
diameter 1

1/2-circle has
diameter $1/2^2=1/4$

A. Li and W. Harter,
Chem. Phys. Letters,
633, 208-213 (2015)

Harter and Alvason Li
Int. Symposium on
Molecular Spectroscopy
OSU Columbus (2013)

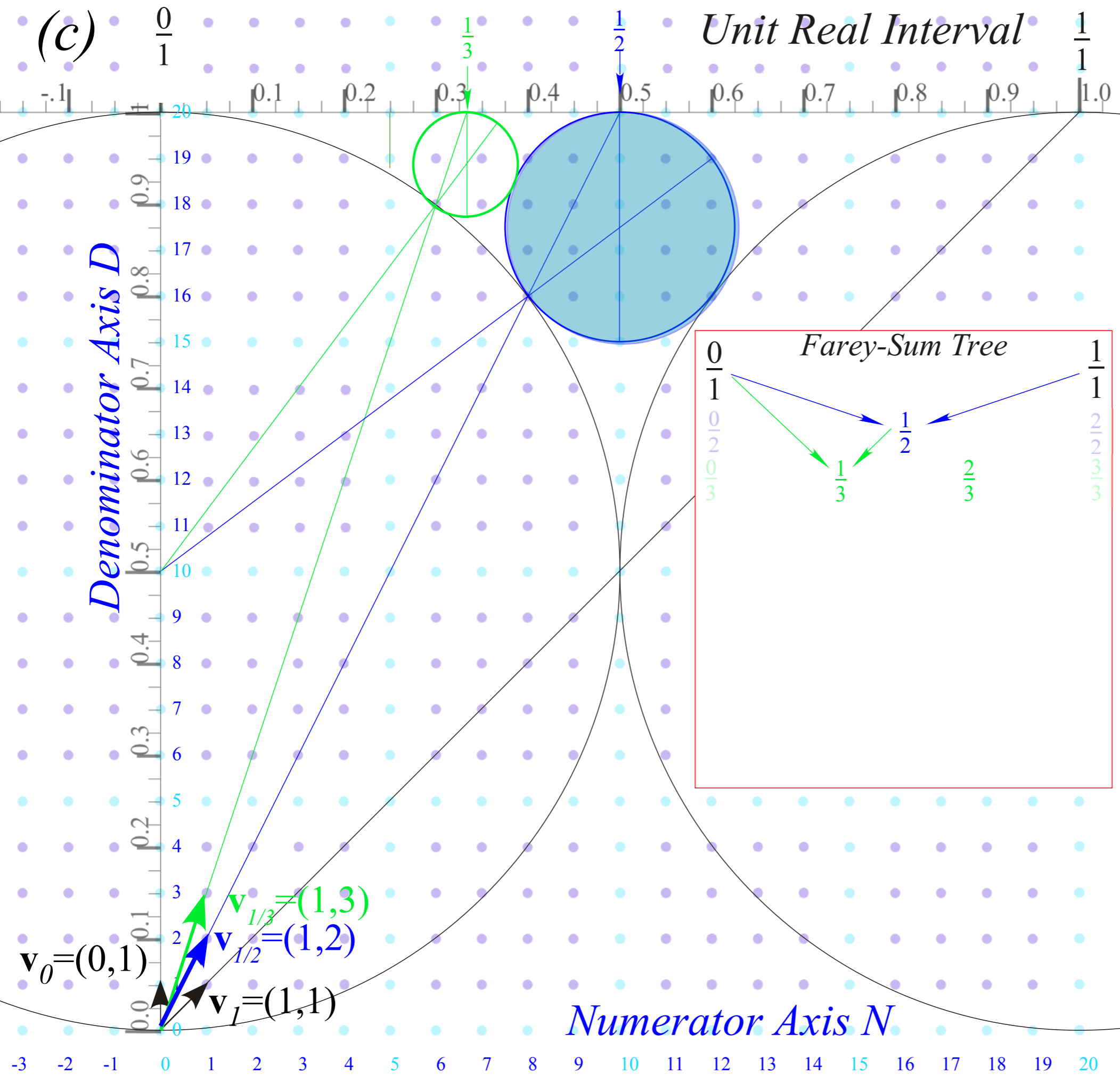

*Farey Sum
related to
vector sum
and
Ford Circles*

$1/2$ -circle has
diameter $1/2^2 = 1/4$

$1/3$ -circles have
diameter $1/3^2 = 1/9$

A. Li and W. Harter,
Chem. Phys. Letters,
633, 208-213 (2015)

Harter and Alvason Li
Int. Symposium on
Molecular Spectroscopy
OSU Columbus (2013)

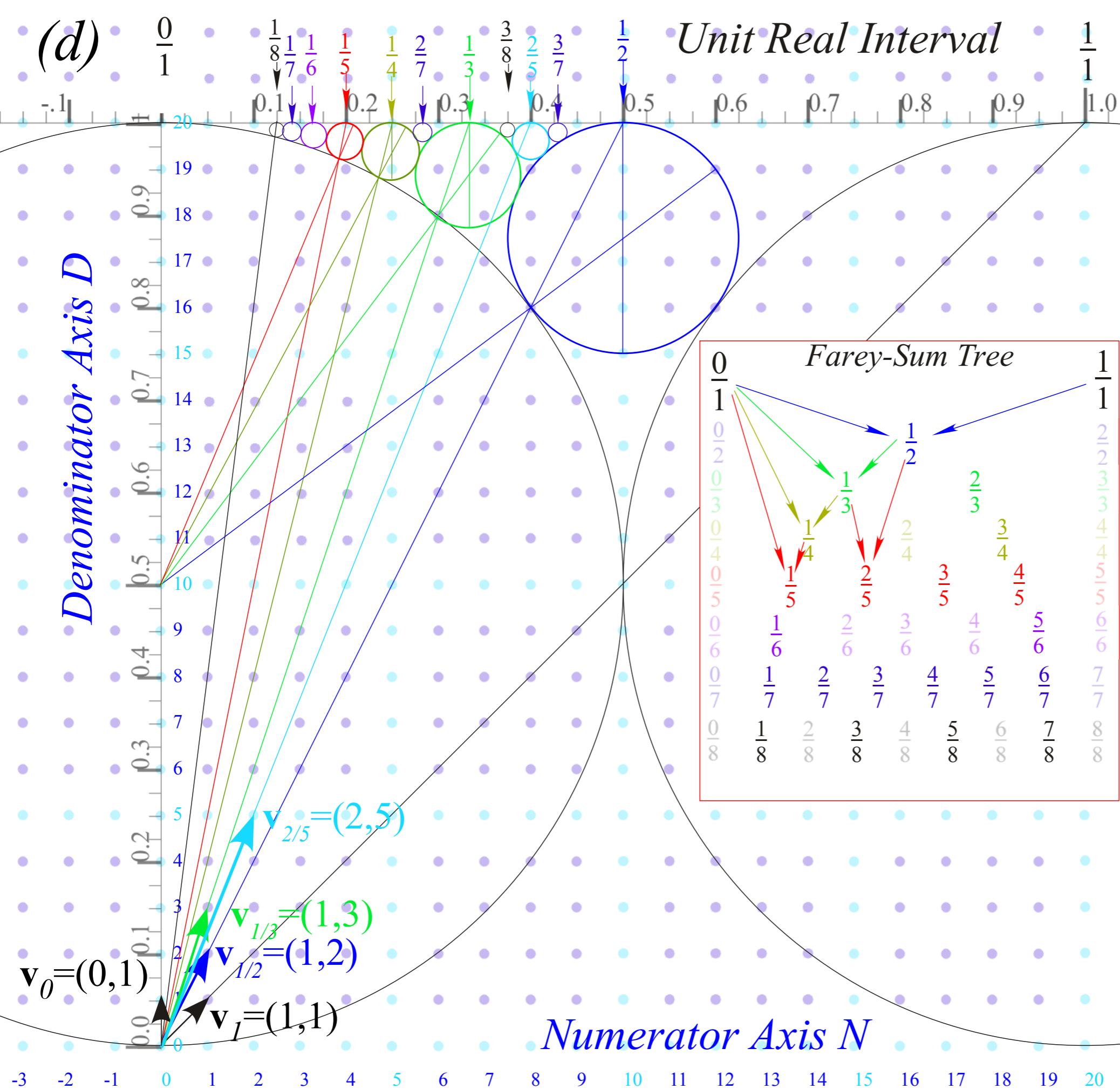

Farey Sum related to vector sum and Ford Circles

A. Li and W. Harter, Chem. Phys. Letters, 633, 208-213 (2015)

Harter and Alvason Li Int. Symposium on Molecular Spectroscopy OSU Columbus (2013)

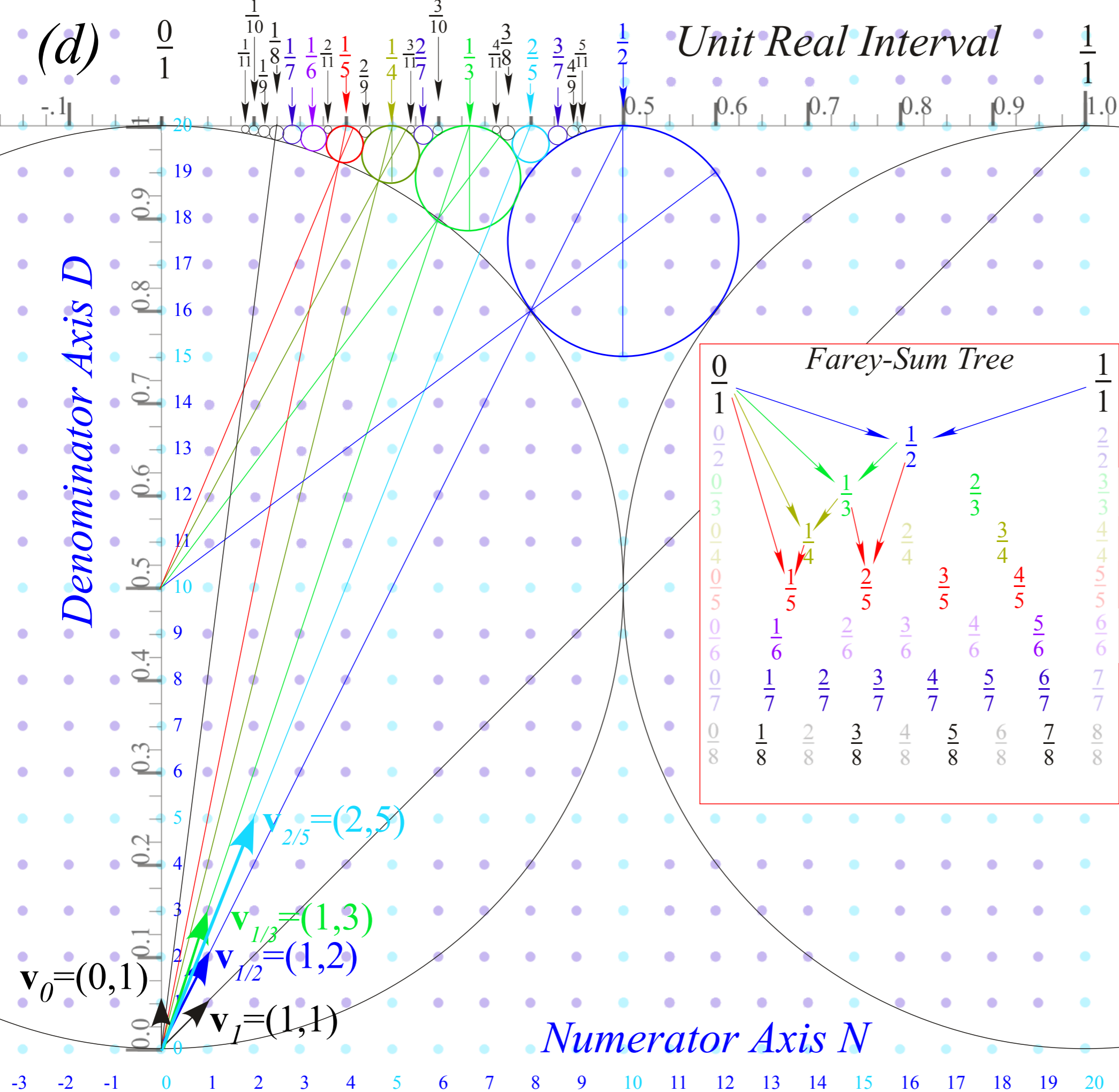

Farey Sum related to vector sum and Ford Circles

1/2-circle has diameter $1/2^2 = 1/4$

1/3-circles have diameter $1/3^2 = 1/9$

n/d-circles have diameter $1/d^2$

A. Li and W. Harter, Chem. Phys. Letters, 633, 208-213 (2015)

Harter and Alvason Li Int. Symposium on Molecular Spectroscopy OSU Columbus (2013)

Thales
Rectangles
provide
analytic geometry
of
fractal structure

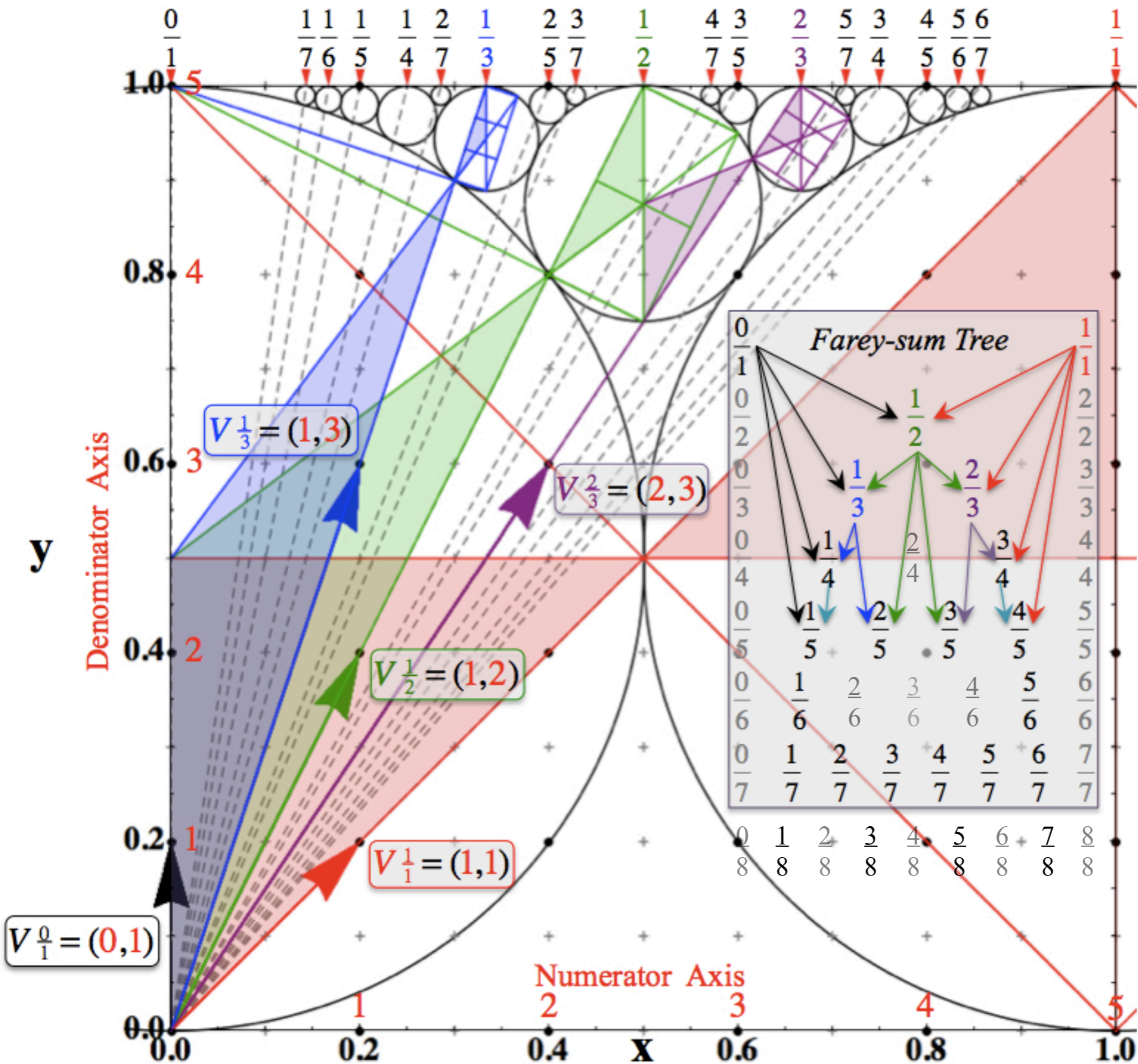

A. Li and W. Harter,
Chem. Phys. Letters,
633, 208-213 (2015)

Harter and Alvason Li
Int. Symposium on
Molecular Spectroscopy
OSU Columbus (2013)

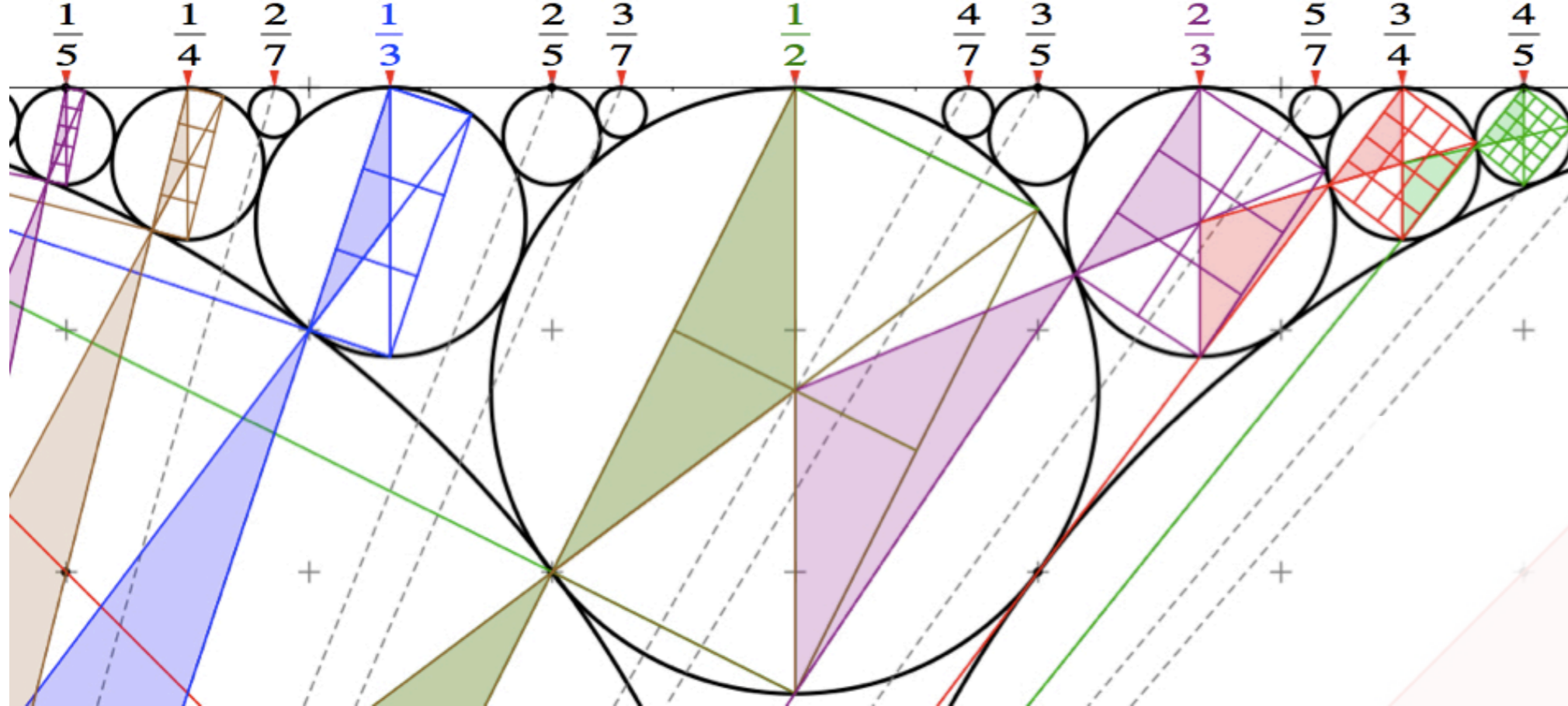

“Quantized”
Thales
Rectangles
provide
analytic geometry
of
fractal structure

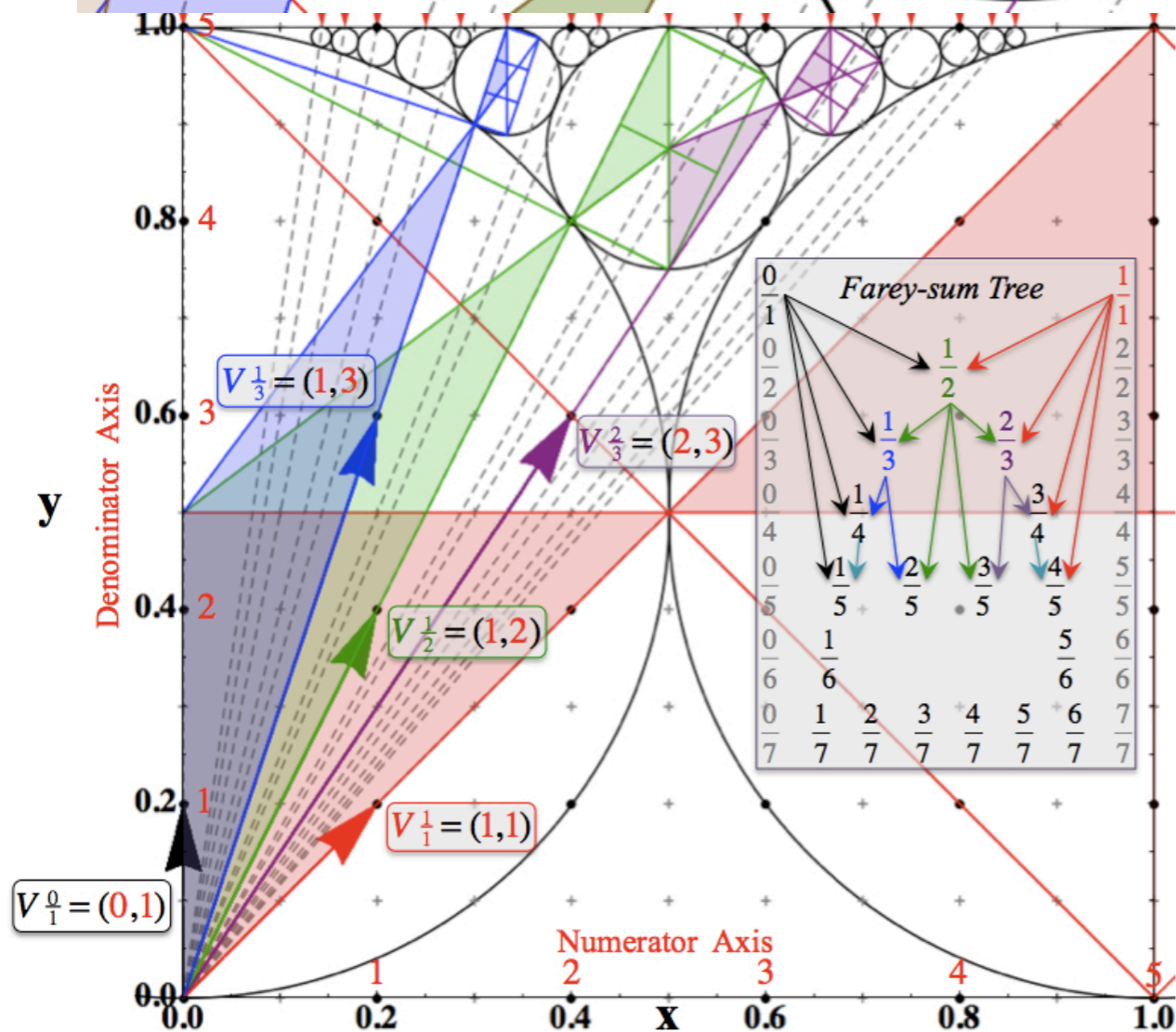

A. Li and W. Harter,
Chem. Phys. Letters,
633, 208-213 (2015)

Harter and Alvason Li
Int. Symposium on
Molecular Spectroscopy
OSU Columbus (2013)

Relating C_N symmetric H and K matrices to differential wave operators

Relating C_N symmetric \mathbf{H} and \mathbf{K} matrices to wave differential operators

The 1st neighbor \mathbf{K} matrix relates to a 2nd *finite-difference* matrix of 2nd x -derivative for high C_N .

$$\mathbf{K} = k(2\mathbf{1} - \mathbf{r} - \mathbf{r}^{-1}) \text{ analogous to: } -k \frac{\partial^2}{\partial x^2}$$

$$\text{1st derivative momentum: } p = \frac{\hbar}{i} \frac{\partial y}{\partial x} \approx \frac{\hbar}{i} \frac{y(x + \Delta x) - y(x)}{(\Delta x)}$$

$$\text{2nd derivative KE: } 2mE = -\hbar^2 \frac{\partial^2 y}{\partial x^2} \approx \frac{y(x + \Delta x) - 2y(x) + y(x - \Delta x)}{(\Delta x)^2}$$

$$\frac{\hbar}{i} \begin{pmatrix} \cdot & \cdot & \cdot & \cdot & \cdot & \cdot \\ \cdot & 1 & -1 & \cdot & \cdot & \cdot \\ \cdot & \cdot & 1 & -1 & \cdot & \cdot \\ \cdot & \cdot & \cdot & 1 & -1 & \cdot \\ \cdot & \cdot & \cdot & \cdot & 1 & \cdot \\ \cdot & \cdot & \cdot & \cdot & \cdot & \cdot \end{pmatrix} \begin{pmatrix} \cdot \\ y_1 \\ y_2 \\ y_3 \\ y_4 \\ \cdot \end{pmatrix} = \frac{\hbar}{i} \begin{pmatrix} \cdot \\ y_1 - y_0 \\ y_2 - y_1 \\ y_3 - y_2 \\ y_4 - y_3 \\ \cdot \end{pmatrix}$$

$$-\hbar^2 \begin{pmatrix} \cdot & \cdot & \cdot & \cdot & \cdot & \cdot \\ -1 & 2 & -1 & \cdot & \cdot & \cdot \\ \cdot & -1 & 2 & -1 & \cdot & \cdot \\ \cdot & \cdot & -1 & 2 & -1 & \cdot \\ \cdot & \cdot & \cdot & -1 & 2 & \cdot \\ \cdot & \cdot & \cdot & \cdot & \cdot & \cdot \end{pmatrix} \begin{pmatrix} \cdot \\ y_1 \\ y_2 \\ y_3 \\ y_4 \\ \cdot \end{pmatrix} = \hbar^2 \begin{pmatrix} \cdot \\ y_0 - 2y_1 + y_2 \\ y_1 - 2y_2 + y_3 \\ y_2 - 2y_3 + y_4 \\ y_3 - 2y_4 + y_5 \\ \cdot \end{pmatrix}$$

\mathbf{H} and \mathbf{K} matrix equations are finite-difference versions of quantum and classical wave equations.

$$i\hbar \frac{\partial}{\partial t} |\psi\rangle = \mathbf{H} |\psi\rangle \quad (\mathbf{H}\text{-matrix equation})$$

$$-\frac{\partial^2}{\partial t^2} |y\rangle = \mathbf{K} |y\rangle \quad (\mathbf{K}\text{-matrix equation})$$

$$i\hbar \frac{\partial}{\partial t} |\psi\rangle = \left(-\frac{\hbar^2}{2m} \frac{\partial^2}{\partial x^2} + V\right) |\psi\rangle \quad (\text{Scrodinger equation})$$

$$-\frac{\partial^2}{\partial t^2} |y\rangle = -k \frac{\partial^2}{\partial x^2} |y\rangle \quad (\text{Classical wave equation})$$

Square p^2 gives 1st neighbor \mathbf{K} matrix. Higher order p^3, p^4, \dots involve 2nd, 3rd, 4th..neighbor \mathbf{H}

$$\frac{\hbar}{i} \begin{pmatrix} \cdot & \cdot & \cdot & \cdot & \cdot & \cdot \\ \cdot & 1 & -1 & \cdot & \cdot & \cdot \\ \cdot & \cdot & 1 & -1 & \cdot & \cdot \\ \cdot & \cdot & \cdot & 1 & -1 & \cdot \\ \cdot & \cdot & \cdot & \cdot & 1 & \cdot \\ \cdot & \cdot & \cdot & \cdot & \cdot & \cdot \end{pmatrix} \frac{\hbar}{i} \begin{pmatrix} \cdot & \cdot & \cdot & \cdot & \cdot & \cdot \\ \cdot & 1 & -1 & \cdot & \cdot & \cdot \\ \cdot & \cdot & 1 & -1 & \cdot & \cdot \\ \cdot & \cdot & \cdot & 1 & -1 & \cdot \\ \cdot & \cdot & \cdot & \cdot & 1 & \cdot \\ \cdot & \cdot & \cdot & \cdot & \cdot & \cdot \end{pmatrix} = \hbar^2 \begin{pmatrix} \cdot & \cdot & \cdot & \cdot & \cdot & \cdot \\ -1 & 2 & -1 & \cdot & \cdot & \cdot \\ \cdot & -1 & 2 & -1 & \cdot & \cdot \\ \cdot & \cdot & -1 & 2 & -1 & \cdot \\ \cdot & \cdot & \cdot & -1 & 2 & \cdot \\ \cdot & \cdot & \cdot & \cdot & \cdot & \cdot \end{pmatrix} \quad p^4 \cong \begin{pmatrix} \cdot & \cdot & \cdot & \cdot & \cdot & \cdot \\ \cdot & \cdot & 1 & \cdot & \cdot & \cdot \\ \dots & 6 & -4 & 1 & \cdot & \cdot \\ 1 & -4 & 6 & -4 & 1 & \cdot \\ \cdot & 1 & -4 & 6 & -4 & 1 \\ \cdot & \cdot & 1 & -4 & 6 & -4 \\ \cdot & \cdot & \cdot & 1 & -4 & 6 \end{pmatrix}$$

Symmetrized finite-difference operators

$$\bar{\Delta} = \frac{1}{2} \begin{pmatrix} \ddots & \vdots & & & & & \\ \dots & 0 & 1 & & & & \\ & -1 & 0 & 1 & & & \\ & & -1 & 0 & 1 & & \\ & & & -1 & 0 & 1 & \\ & & & & -1 & 0 & \\ & & & & & -1 & 0 \end{pmatrix}, \bar{\Delta}^3 = \frac{1}{2^3} \begin{pmatrix} \ddots & \vdots & 0 & -1 & & & \\ \dots & 0 & 3 & 0 & -1 & & \\ & 0 & -3 & 0 & 3 & 0 & -1 \\ & 1 & 0 & -3 & 0 & 3 & 0 \\ & & 1 & 0 & -3 & 0 & 3 \\ & & & 1 & 0 & -3 & 0 \end{pmatrix}$$

$$\bar{\Delta}^2 = \frac{1}{2^2} \begin{pmatrix} \ddots & \vdots & 1 & & & & \\ \dots & -2 & 0 & 1 & & & \\ 1 & 0 & -2 & 0 & 1 & & \\ & 1 & 0 & -2 & 0 & 1 & \\ & & 1 & 0 & -2 & 0 & \\ & & & 1 & 0 & -2 & \end{pmatrix}, \bar{\Delta}^4 = \frac{1}{2^4} \begin{pmatrix} \ddots & \vdots & -4 & 0 & 1 & & \\ \dots & 6 & 0 & -4 & 0 & 1 & \\ -4 & 0 & 6 & 0 & -4 & 0 & \\ 0 & -4 & 0 & 6 & 0 & -4 & \\ 1 & 0 & -4 & 0 & 6 & 0 & \\ & 1 & 0 & -4 & 0 & 6 & \end{pmatrix}$$