

Group Theory in Quantum Mechanics

Lecture 7 (2.5.13)

Spectral Analysis of $U(2)$ Operators

(Quantum Theory for Computer Age - Ch. 10 of Unit 3)

(Principles of Symmetry, Dynamics, and Spectroscopy - Sec. 1-3 of Ch. 5)

Review: How C_2 (Bilateral σ_B reflection) symmetry is eigen-solver & three famous 2-state systems

$U(2)$ vs $R(3)$: 2-State Schrodinger: $i\hbar\partial_t|\Psi(t)\rangle = \mathbf{H}|\Psi(t)\rangle$ vs. Classical 2D-HO: $\partial_t^2\mathbf{x} = -\mathbf{K}\cdot\mathbf{x}$

Hamilton-Pauli spinor symmetry (σ -expansion in ABCD-Types) $\mathbf{H} = \omega_\mu \sigma_\mu$

Deriving σ -exponential time evolution (or revolution) operator $\mathbf{U} = e^{-i\mathbf{H}t} = e^{-i\sigma_\mu \omega_\mu t}$

Spinor arithmetic like complex arithmetic

Spinor vector algebra like complex vector algebra

Spinor exponentials like complex exponentials ("Crazy-Thing"-Theorem)

Geometry of $U(2)$ evolution (or $R(3)$ revolution) operator $\mathbf{U} = e^{-i\mathbf{H}t} = e^{-i\sigma_\mu \omega_\mu t}$

The "mysterious" factors of 2 (or 1/2): 2D Spinor vs 3D Spin Vector space

2D Spinor vs 3D vector rotation

NMR Hamiltonian: 3D Spin Moment \mathbf{m} in \mathbf{B} field

Euler's state definition using rotations $\mathbf{R}(\alpha, 0, 0)$, $\mathbf{R}(0, \beta, 0)$, and $\mathbf{R}(0, 0, \gamma)$

Spin-1 (3D-real vector) case

Spin-1/2 (2D-complex spinor) case

3D-real Stokes Vector defines 2D-HO polarization ellipses and spinor states

Asymmetry $S_A = S_Z$, Balance $S_B = S_X$, and Chirality $S_C = S_Y$

Polarization ellipse and spinor state dynamics

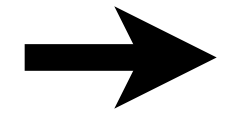

Review: How C_2 (Bilateral σ_B reflection) symmetry is eigen-solver

Review: How symmetry groups become eigen-solvers

Suppose you need to diagonalize a complicated operator \mathbf{K} and knew that \mathbf{K} commutes with some other operators \mathbf{G} and \mathbf{H} for which irreducible projectors are more easily found.

$$\begin{aligned} \mathbf{KG} = \mathbf{GK} \text{ or } \mathbf{G}^\dagger \mathbf{KG} = \mathbf{K} \text{ or } \mathbf{GKG}^\dagger = \mathbf{K} & \quad (\text{Here assuming } \textit{unitary} \\ \mathbf{KH} = \mathbf{HK} \text{ or } \mathbf{H}^\dagger \mathbf{KH} = \mathbf{K} \text{ or } \mathbf{HKH}^\dagger = \mathbf{K} & \quad \mathbf{G}^\dagger = \mathbf{G}^{-1} \text{ and } \mathbf{H}^\dagger = \mathbf{H}^{-1}.) \end{aligned}$$

This means \mathbf{K} is *invariant* to the transformation by \mathbf{G} and \mathbf{H} and all their products \mathbf{GH} , \mathbf{GH}^2 , $\mathbf{G}^2\mathbf{H}$,... *etc.* and all their inverses \mathbf{G}^\dagger , \mathbf{H}^\dagger ,... *etc.*

The group $\mathcal{G}_{\mathbf{K}} = \{\mathbf{1}, \mathbf{G}, \mathbf{H}, \dots\}$ so formed by such operators is called a *symmetry group* for \mathbf{K} .

In certain ideal cases a \mathbf{K} -matrix $\langle \mathbf{K} \rangle$ is a linear combination of matrices $\langle \mathbf{1} \rangle$, $\langle \mathbf{G} \rangle$, $\langle \mathbf{H} \rangle$,... from $\mathcal{G}_{\mathbf{K}}$. Then spectral resolution of $\{\langle \mathbf{1} \rangle, \langle \mathbf{G} \rangle, \langle \mathbf{H} \rangle, \dots\}$ also resolves $\langle \mathbf{K} \rangle$.

We will study ideal cases first. More general cases are built from this idea.

C_2 Symmetric two-dimensional harmonic oscillators (2DHO)

2D HO "binary" bases and coord. $\{x_0, x_1\}$

(a) unit base state

$$|0\rangle = |x\rangle = |2\rangle = \begin{pmatrix} 1 \\ 0 \end{pmatrix}$$

(b) unit base state

$$|1\rangle = |y\rangle = |-1\rangle = \begin{pmatrix} 0 \\ 1 \end{pmatrix}$$

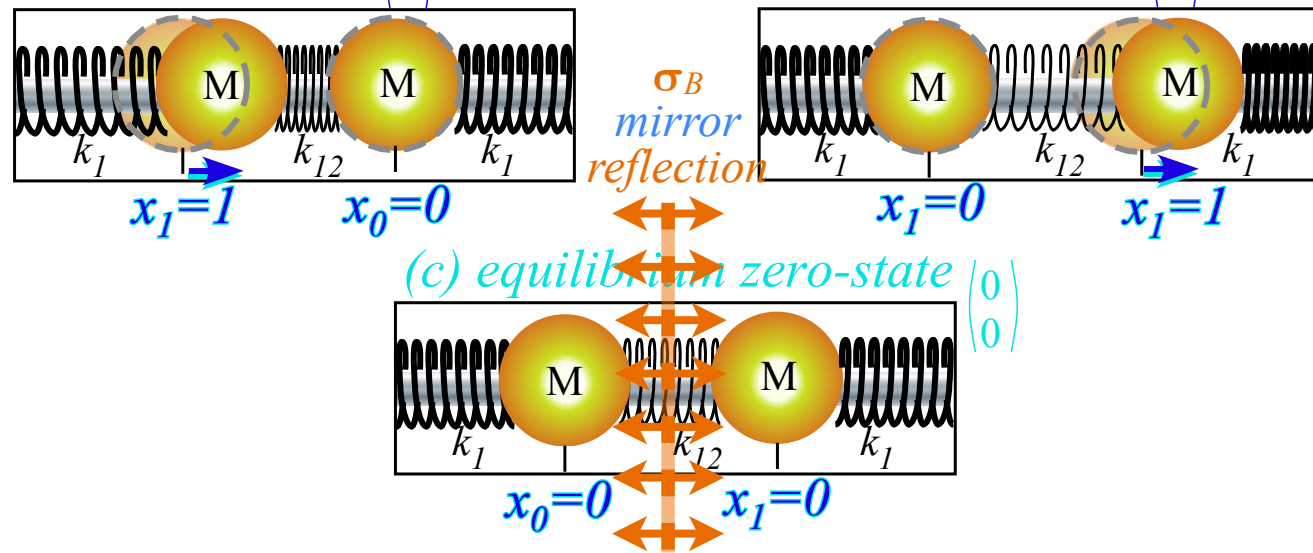

2D HO Matrix operator equations

$$\begin{pmatrix} \ddot{x}_1 \\ \ddot{x}_2 \end{pmatrix} = - \begin{pmatrix} \frac{k_1 + k_{12}}{M} & \frac{-k_{12}}{M} \\ \frac{-k_{12}}{M} & \frac{k_1 + k_{12}}{M} \end{pmatrix} \begin{pmatrix} x_1 \\ x_2 \end{pmatrix}$$

$$= - \begin{pmatrix} K_{11} & K_{12} \\ K_{21} & K_{22} \end{pmatrix} \begin{pmatrix} x_1 \\ x_2 \end{pmatrix} \quad \text{More conventional coordinate notation}$$

$$|\ddot{\mathbf{x}}\rangle = - \mathbf{K} |\mathbf{x}\rangle \quad \{x_0, x_1\} \rightarrow \{x_1, x_2\}$$

C_2 (Bilateral σ_B reflection) symmetry conditions:

$$K_{11} \equiv K \equiv K_{22} \text{ and: } K_{12} \equiv k \equiv K_{21} = -k_{12} \quad (\text{Let: } M=1)$$

$$\begin{pmatrix} K_{11} & K_{12} \\ K_{21} & K_{22} \end{pmatrix} = \begin{pmatrix} K & k \\ k & K \end{pmatrix} = K \begin{pmatrix} 1 & 0 \\ 0 & 1 \end{pmatrix} + k \begin{pmatrix} 0 & 1 \\ 1 & 0 \end{pmatrix}$$

$$\mathbf{K} = K \cdot \mathbf{1} + k \cdot \sigma_B$$

K -matrix is made of its symmetry operators in

group $C_2 = \{\mathbf{1}, \sigma_B\}$ with product table:

C_2	$\mathbf{1}$	σ_B
$\mathbf{1}$	$\mathbf{1}$	σ_B
σ_B	σ_B	$\mathbf{1}$

Symmetry product table gives C_2 group representations in group basis $\{|0\rangle = \mathbf{1}|0\rangle \equiv |\mathbf{1}\rangle, |1\rangle = \sigma_B|0\rangle \equiv |\sigma_B\rangle\}$

$$\begin{pmatrix} \langle \mathbf{1} | \mathbf{1} | \mathbf{1} \rangle & \langle \mathbf{1} | \mathbf{1} | \sigma_B \rangle \\ \langle \sigma_B | \mathbf{1} | \mathbf{1} \rangle & \langle \sigma_B | \mathbf{1} | \sigma_B \rangle \end{pmatrix} = \begin{pmatrix} 1 & 0 \\ 0 & 1 \end{pmatrix}, \quad \begin{pmatrix} \langle \mathbf{1} | \sigma_B | \mathbf{1} \rangle & \langle \mathbf{1} | \sigma_B | \sigma_B \rangle \\ \langle \sigma_B | \sigma_B | \mathbf{1} \rangle & \langle \sigma_B | \sigma_B | \sigma_B \rangle \end{pmatrix} = \begin{pmatrix} 0 & 1 \\ 1 & 0 \end{pmatrix}$$

\mathbf{P}^\pm -projectors:

$$\mathbf{P}^+ = \frac{\mathbf{1} + \sigma_B}{2} = \begin{pmatrix} \frac{1}{2} & \frac{1}{2} \\ \frac{1}{2} & \frac{1}{2} \end{pmatrix}$$

$$\mathbf{P}^- = \frac{\mathbf{1} - \sigma_B}{2} = \begin{pmatrix} \frac{1}{2} & -\frac{1}{2} \\ -\frac{1}{2} & \frac{1}{2} \end{pmatrix}$$

Minimal equation of σ_B is: $\sigma_B^2 = 1$

$$\text{or: } \sigma_B^2 - 1 = 0 = (\sigma_B - 1)(\sigma_B + 1)$$

with eigenvalues:

$$\{\chi^+(\sigma_B) = +1, \chi^-(\sigma_B) = -1\}$$

Spectral decomposition of $C_2(\sigma_B)$ into $\{\mathbf{P}^+, \mathbf{P}^-\}$

$$\mathbf{1} = \mathbf{P}^+ + \mathbf{P}^-$$

$$\sigma_B = \mathbf{P}^+ - \mathbf{P}^-$$

C_2 Symmetric 2DHO eigensolutions

$$\mathbf{K} = K \cdot \mathbf{1} - k_{12} \cdot \sigma_B$$

K -matrix is made of its symmetry operators

$$K \begin{pmatrix} 1 & 0 \\ 0 & 1 \end{pmatrix} - k_{12} \begin{pmatrix} 0 & 1 \\ 1 & 0 \end{pmatrix} = \begin{pmatrix} k_1 + k_{12} & -k_{12} \\ -k_{12} & k_1 + k_{12} \end{pmatrix}$$

in group $C_2 = \{\mathbf{1}, \sigma_B\}$ with product table:

$C_2(\sigma_B)$ spectrally decomposed into $\{\mathbf{P}^+, \mathbf{P}^-\}$ projectors:

$$\mathbf{1} = \mathbf{P}^+ + \mathbf{P}^-$$

$$\sigma_B = \mathbf{P}^+ - \mathbf{P}^-$$

Eigenvalues of σ_B :

$$\{\chi^+(\sigma_B) = +1, \chi^-(\sigma_B) = -1\}$$

Eigenvalues of $\mathbf{K} = K \cdot \mathbf{1} - k_{12} \cdot \sigma_B$:

$$\begin{aligned} \varepsilon^+(\mathbf{K}) &= K - k_{12}, & \varepsilon^-(\mathbf{K}) &= K + k_{12} \\ &= k_1, & &= k_1 + 2k_{12} \end{aligned}$$

Even mode $|+\rangle = |0_2\rangle = \begin{pmatrix} 1 \\ 1 \end{pmatrix} / \sqrt{2}$

C_2 mode phase character tables

p is position
 $p=0 \quad p=1$

$m=0$

$m=0$	1	1
$m=1$	1	-1

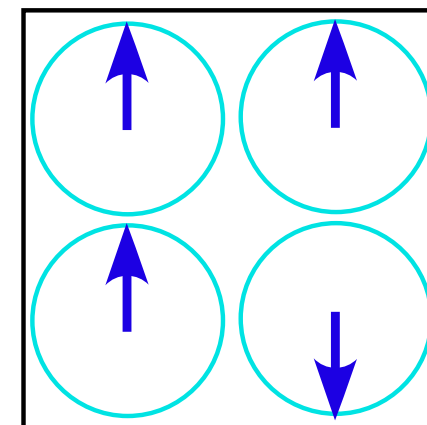

norm: $1/\sqrt{2}$

(D-tran)

$$\begin{pmatrix} \frac{1}{\sqrt{2}} & \frac{1}{\sqrt{2}} \\ \frac{1}{\sqrt{2}} & -\frac{1}{\sqrt{2}} \end{pmatrix} =$$

$$\begin{pmatrix} \langle x_1 | + \rangle & \langle x_1 | - \rangle \\ \langle x_2 | + \rangle & \langle x_2 | - \rangle \end{pmatrix}$$

(D-tran is its own inverse in this case!)

Diagonalizing transformation (D-tran) of K -matrix:

$$\begin{pmatrix} \frac{1}{\sqrt{2}} & \frac{1}{\sqrt{2}} \\ \frac{1}{\sqrt{2}} & -\frac{1}{\sqrt{2}} \end{pmatrix} \begin{pmatrix} k_1 + k_{12} & -k_{12} \\ -k_{12} & k_1 + k_{12} \end{pmatrix} \begin{pmatrix} \frac{1}{\sqrt{2}} & \frac{1}{\sqrt{2}} \\ \frac{1}{\sqrt{2}} & -\frac{1}{\sqrt{2}} \end{pmatrix} = \begin{pmatrix} k_1 & 0 \\ 0 & k_1 + 2k_{12} \end{pmatrix}$$

factored projectors

$$\mathbf{P}^+ = \frac{\mathbf{1} + \sigma_B}{2} = \begin{pmatrix} \frac{1}{2} & \frac{1}{2} \\ \frac{1}{2} & \frac{1}{2} \end{pmatrix} = \begin{pmatrix} \frac{1}{\sqrt{2}} \\ \frac{1}{\sqrt{2}} \end{pmatrix} \otimes \begin{pmatrix} \frac{1}{\sqrt{2}} & \frac{1}{\sqrt{2}} \end{pmatrix} = |+\rangle \langle +|$$

$$\mathbf{P}^- = \frac{\mathbf{1} - \sigma_B}{2} = \begin{pmatrix} \frac{1}{2} & -\frac{1}{2} \\ -\frac{1}{2} & \frac{1}{2} \end{pmatrix} = \begin{pmatrix} \frac{1}{\sqrt{2}} \\ -\frac{1}{\sqrt{2}} \end{pmatrix} \otimes \begin{pmatrix} \frac{1}{\sqrt{2}} & -\frac{1}{\sqrt{2}} \end{pmatrix} = |-\rangle \langle -|$$

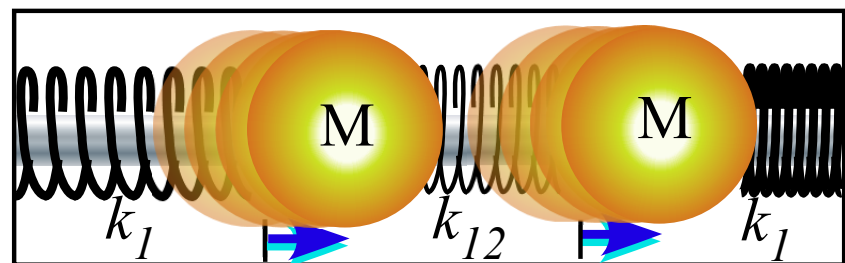

$$x_0 = 1/\sqrt{2} \quad x_1 = 1/\sqrt{2}$$

Odd mode $|-\rangle = |1_2\rangle = \begin{pmatrix} 1 \\ -1 \end{pmatrix} / \sqrt{2}$

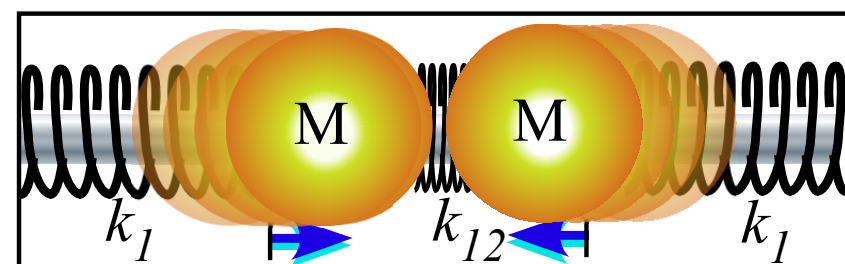

$$x_0 = 1/\sqrt{2} \quad x_1 = -1/\sqrt{2}$$

m is wave-number or "momentum"

C_2 Symmetric 2DHO uncoupling

2D HO Matrix operator equations are coupled in $\{x_1, x_2\}$ -basis ...but are **uncoupled** in $\{+, -\}$ -basis

$$\begin{pmatrix} \ddot{x}_1 \\ \ddot{x}_2 \end{pmatrix} = - \begin{pmatrix} k_1 + k_{12} & -k_{12} \\ -k_{12} & k_1 + k_{12} \end{pmatrix} \begin{pmatrix} x_1 \\ x_2 \end{pmatrix}$$

$$|\ddot{\mathbf{x}}\rangle = -\mathbf{K} |\mathbf{x}\rangle$$

$$\begin{pmatrix} \langle x_1 | \ddot{\mathbf{x}} \rangle \\ \langle x_2 | \ddot{\mathbf{x}} \rangle \end{pmatrix} = - \begin{pmatrix} \langle x_1 | \mathbf{K} | x_1 \rangle & \langle x_1 | \mathbf{K} | x_2 \rangle \\ \langle x_2 | \mathbf{K} | x_1 \rangle & \langle x_2 | \mathbf{K} | x_2 \rangle \end{pmatrix} \begin{pmatrix} \langle x_1 | \mathbf{x} \rangle \\ \langle x_2 | \mathbf{x} \rangle \end{pmatrix}$$

$$\begin{pmatrix} \ddot{x}_+ \\ \ddot{x}_- \end{pmatrix} = - \begin{pmatrix} k_1 & 0 \\ 0 & k_1 + 2k_{12} \end{pmatrix} \begin{pmatrix} x_+ \\ x_- \end{pmatrix}$$

$$|\ddot{\mathbf{x}}\rangle = -\mathbf{K} |\mathbf{x}\rangle$$

$$\begin{pmatrix} \langle + | \ddot{\mathbf{x}} \rangle \\ \langle - | \ddot{\mathbf{x}} \rangle \end{pmatrix} = - \begin{pmatrix} \langle + | \mathbf{K} | + \rangle & \langle + | \mathbf{K} | - \rangle \\ \langle - | \mathbf{K} | + \rangle & \langle - | \mathbf{K} | - \rangle \end{pmatrix} \begin{pmatrix} \langle + | \mathbf{x} \rangle \\ \langle - | \mathbf{x} \rangle \end{pmatrix}$$

Eigenbra vectors: $\langle + | = \left(\frac{1}{\sqrt{2}} \quad \frac{1}{\sqrt{2}} \right)$, $\langle - | = \left(\frac{1}{\sqrt{2}} \quad -\frac{1}{\sqrt{2}} \right)$

Eigenket vectors: $|+\rangle = \begin{pmatrix} \frac{1}{\sqrt{2}} \\ \frac{1}{\sqrt{2}} \end{pmatrix}$, $|-\rangle = \begin{pmatrix} \frac{1}{\sqrt{2}} \\ -\frac{1}{\sqrt{2}} \end{pmatrix}$

C_2 Symmetric 2DHO **uncoupled** dynamics

Each mode runs independently

$$\begin{pmatrix} M\ddot{x}_+ + (k_1)x_+ \\ M\ddot{x}_- + (k_1 + 2k_{12})x_- \end{pmatrix} = \begin{pmatrix} 0 \\ 0 \end{pmatrix}$$

(+)-mode at frequency $\omega_+ = \sqrt{k_1/M}$

(-)-mode at frequency $\omega_- = \sqrt{(k_1 + 2k_{12})/M}$

Spectral decomposition of initial state $\mathbf{x}(0) = (x_1 \ x_2) = (1, 0)$:

$$\mathbf{1} \cdot \mathbf{x}(0) = (\mathbf{P}_+ + \mathbf{P}_-) \begin{pmatrix} 1 \\ 0 \end{pmatrix} = \begin{pmatrix} \frac{1}{\sqrt{2}} \\ \frac{1}{\sqrt{2}} \end{pmatrix} \otimes \begin{pmatrix} \frac{1}{\sqrt{2}} & \frac{1}{\sqrt{2}} \end{pmatrix} \begin{pmatrix} 1 \\ 0 \end{pmatrix} + \begin{pmatrix} \frac{1}{\sqrt{2}} \\ -\frac{1}{\sqrt{2}} \end{pmatrix} \otimes \begin{pmatrix} \frac{1}{\sqrt{2}} & -\frac{1}{\sqrt{2}} \end{pmatrix} \begin{pmatrix} 1 \\ 0 \end{pmatrix}$$

$$\mathbf{x}(0) = \begin{pmatrix} \frac{1}{\sqrt{2}} \\ \frac{1}{\sqrt{2}} \end{pmatrix} \left(\frac{1}{\sqrt{2}} \right) + \begin{pmatrix} \frac{1}{\sqrt{2}} \\ -\frac{1}{\sqrt{2}} \end{pmatrix} \left(\frac{1}{\sqrt{2}} \right) = \frac{1}{\sqrt{2}} |+\rangle + \frac{1}{\sqrt{2}} |-\rangle = \begin{pmatrix} \frac{1}{2} \\ \frac{1}{2} \end{pmatrix} + \begin{pmatrix} \frac{1}{2} \\ -\frac{1}{2} \end{pmatrix}$$

$$\text{so: } \mathbf{x}(t) = e^{-i\omega_+ t} \begin{pmatrix} \frac{1}{2} \\ \frac{1}{2} \end{pmatrix} + e^{-i\omega_- t} \begin{pmatrix} \frac{1}{2} \\ -\frac{1}{2} \end{pmatrix}$$

100% AM modulation results

$$\frac{e^{ia} + e^{ib}}{2} = e^{i\frac{a+b}{2}} \frac{e^{i\frac{a-b}{2}} + e^{-i\frac{a-b}{2}}}{2} = e^{i\frac{a+b}{2}} \cos\left(\frac{a-b}{2}\right)$$

$$\begin{pmatrix} x_1(t) \\ x_2(t) \end{pmatrix} = \begin{pmatrix} \frac{e^{-i\omega_+ t} + e^{-i\omega_- t}}{2} \\ \frac{e^{-i\omega_+ t} - e^{-i\omega_- t}}{2} \end{pmatrix} = \frac{e^{-i\frac{(\omega_+ + \omega_-)t}}{2}} \begin{pmatrix} e^{-i\frac{(\omega_+ - \omega_-)t}}{2} + e^{i\frac{(\omega_+ - \omega_-)t}}{2} \\ e^{-i\frac{(\omega_+ - \omega_-)t}}{2} - e^{i\frac{(\omega_+ - \omega_-)t}}{2} \end{pmatrix} = e^{-i\frac{(\omega_+ + \omega_-)t}{2}} \begin{pmatrix} \cos\frac{(\omega_- - \omega_+)t}{2} \\ i \sin\frac{(\omega_- - \omega_+)t}{2} \end{pmatrix}$$

Note the i phase

Mixed mode dynamics

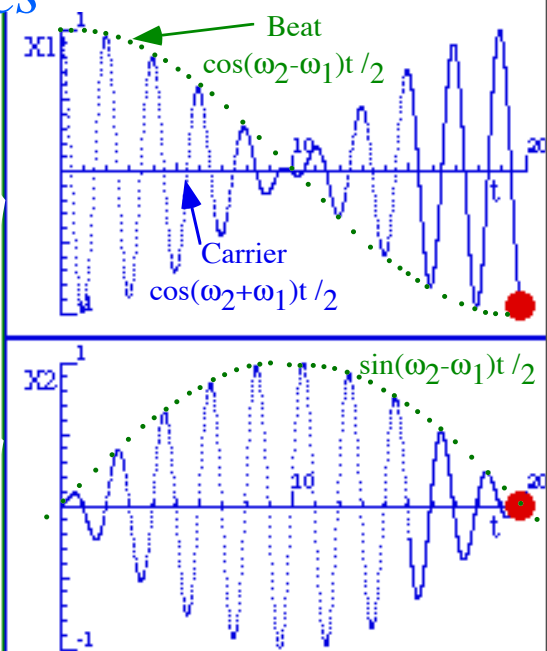
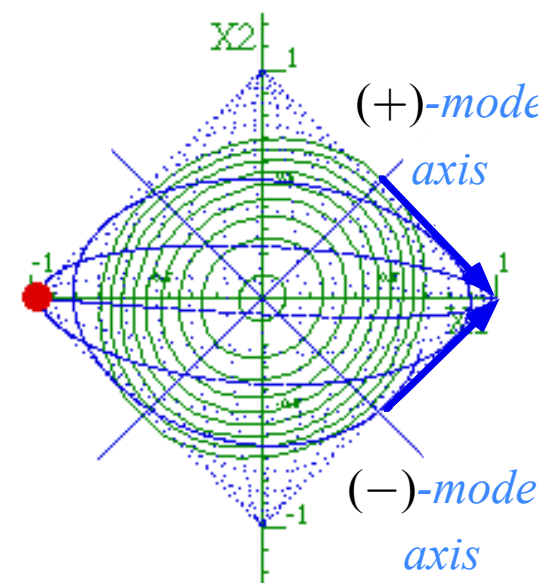

2D HO potential energy $V(x_1, x_2)$ quadratic form defines layers of elliptical V -contours (Here: $k_1 = k = k_2$)

$$V = \frac{1}{2}(k + k_{12})x_1^2 - k_{12}x_1x_2 + \frac{1}{2}(k + k_{12})x_2^2 = \frac{1}{2}\langle \mathbf{x} | \mathbf{K} | \mathbf{x} \rangle = \frac{1}{2}\mathbf{x} \cdot \mathbf{K} \cdot \mathbf{x} = \begin{pmatrix} x_1 & x_2 \end{pmatrix} \begin{pmatrix} k + k_{12} & -k_{12} \\ -k_{12} & k + k_{12} \end{pmatrix} \begin{pmatrix} x_1 \\ x_2 \end{pmatrix}$$

(a) PE Contours and gradients

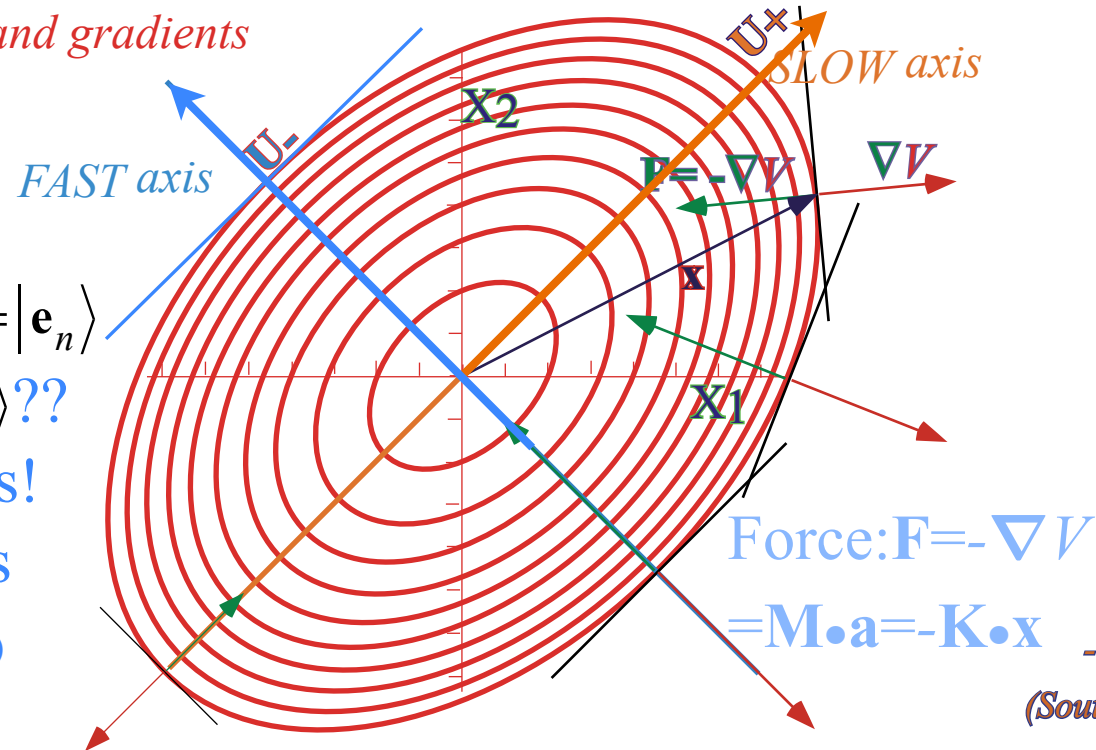

What direction $|\mathbf{x}\rangle = |\mathbf{e}_n\rangle$ is the same as $\mathbf{K}|\mathbf{x}\rangle$??
 Not most directions!
 Only extremal axes work. (major or minor axes)

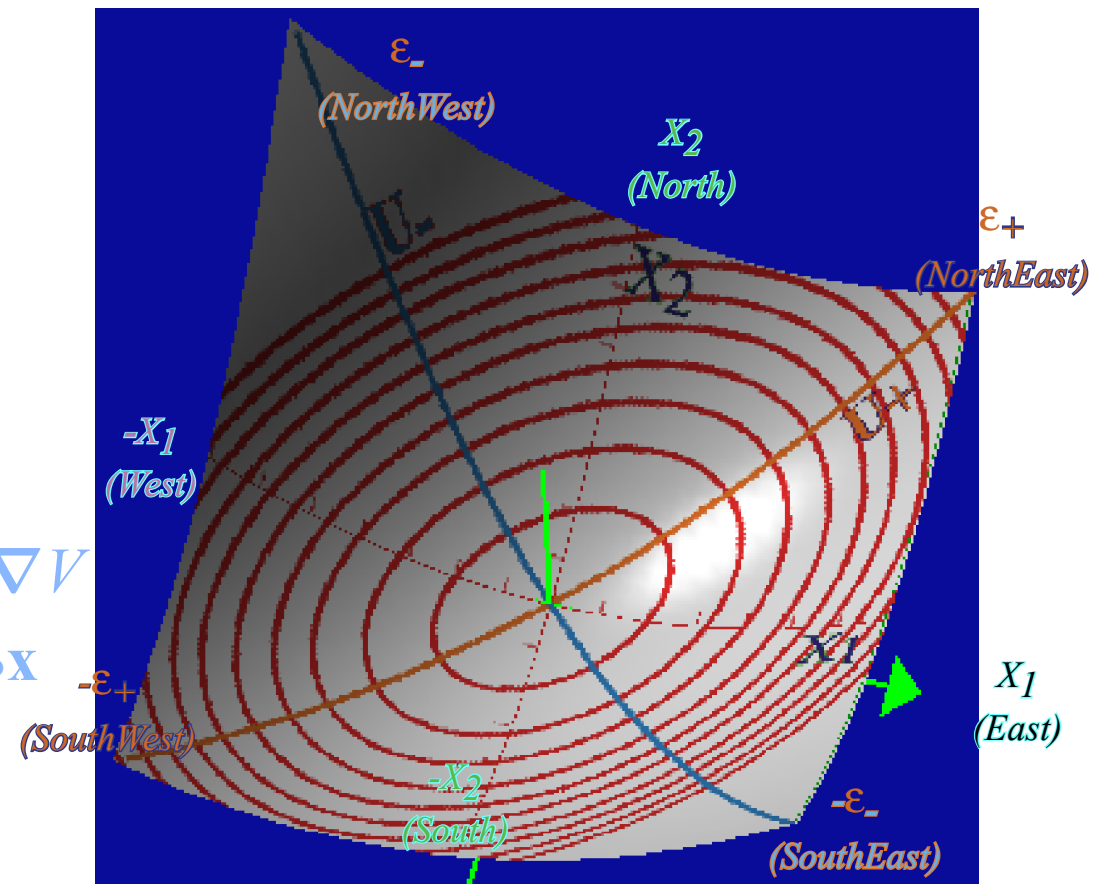
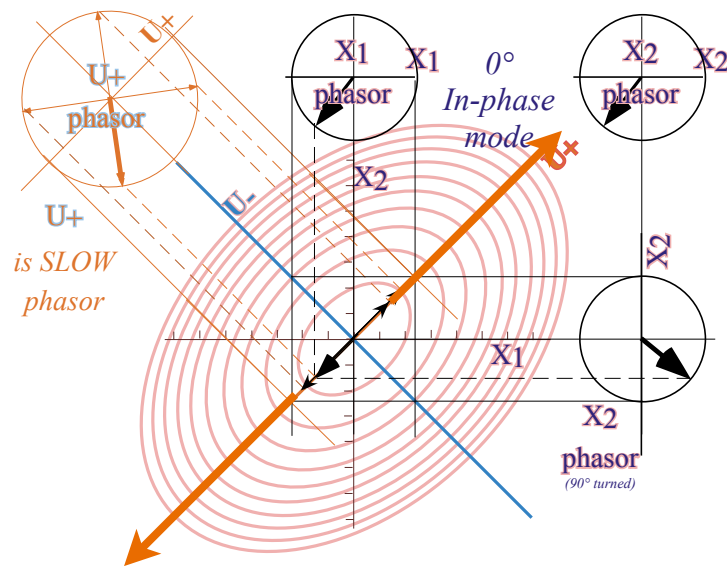
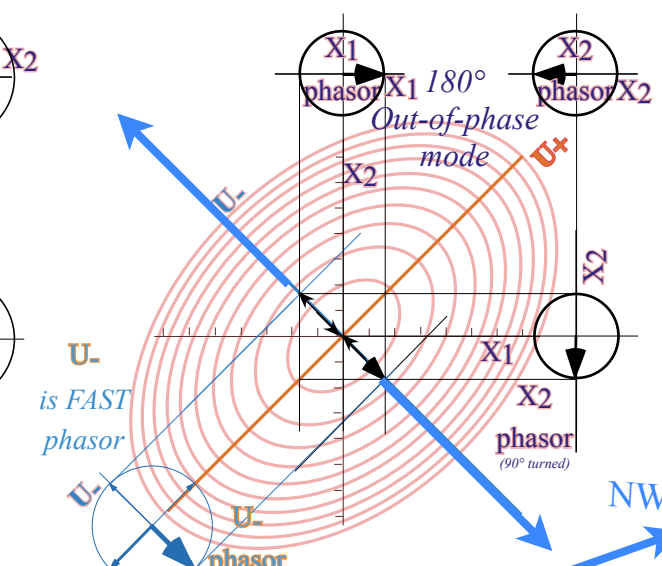

Fig. 3.3.4 Plot of potential function $V(x_1, x_2)$ showing elliptical $V(x_1, x_2) = \text{const.}$ level curves.

(b) Symmetric $U+$ Coordinate SLOW Mode



(c) Anti-symmetric $U-$ Coordinate FAST Mode



With Bilateral symmetry ($k_1 = k = k_2$) the extremal axes lie at $\pm 45^\circ$

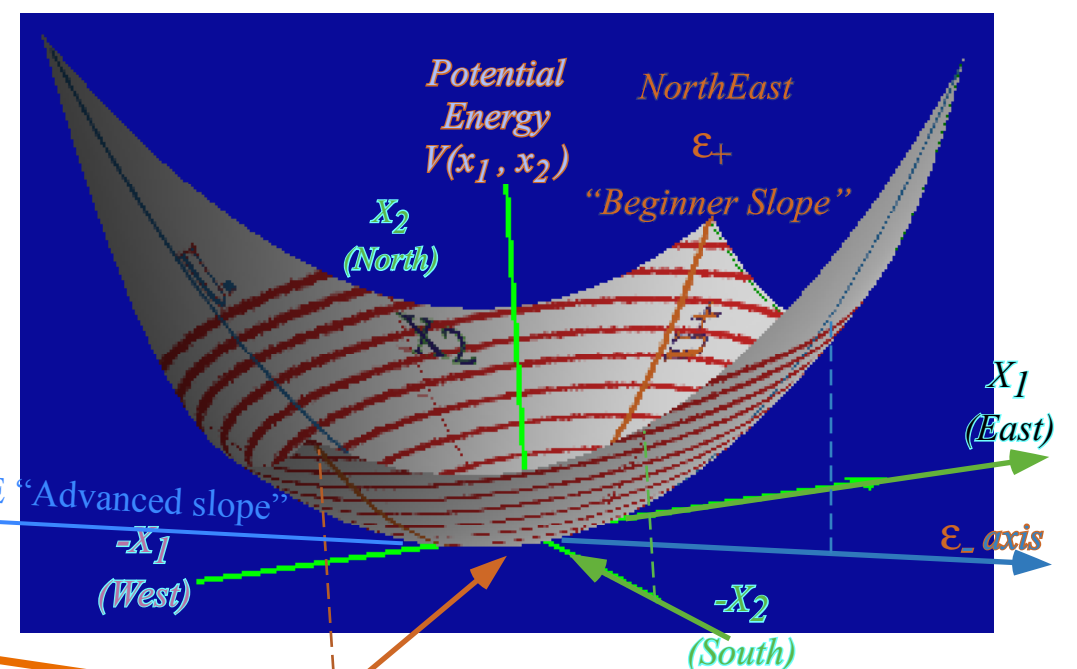
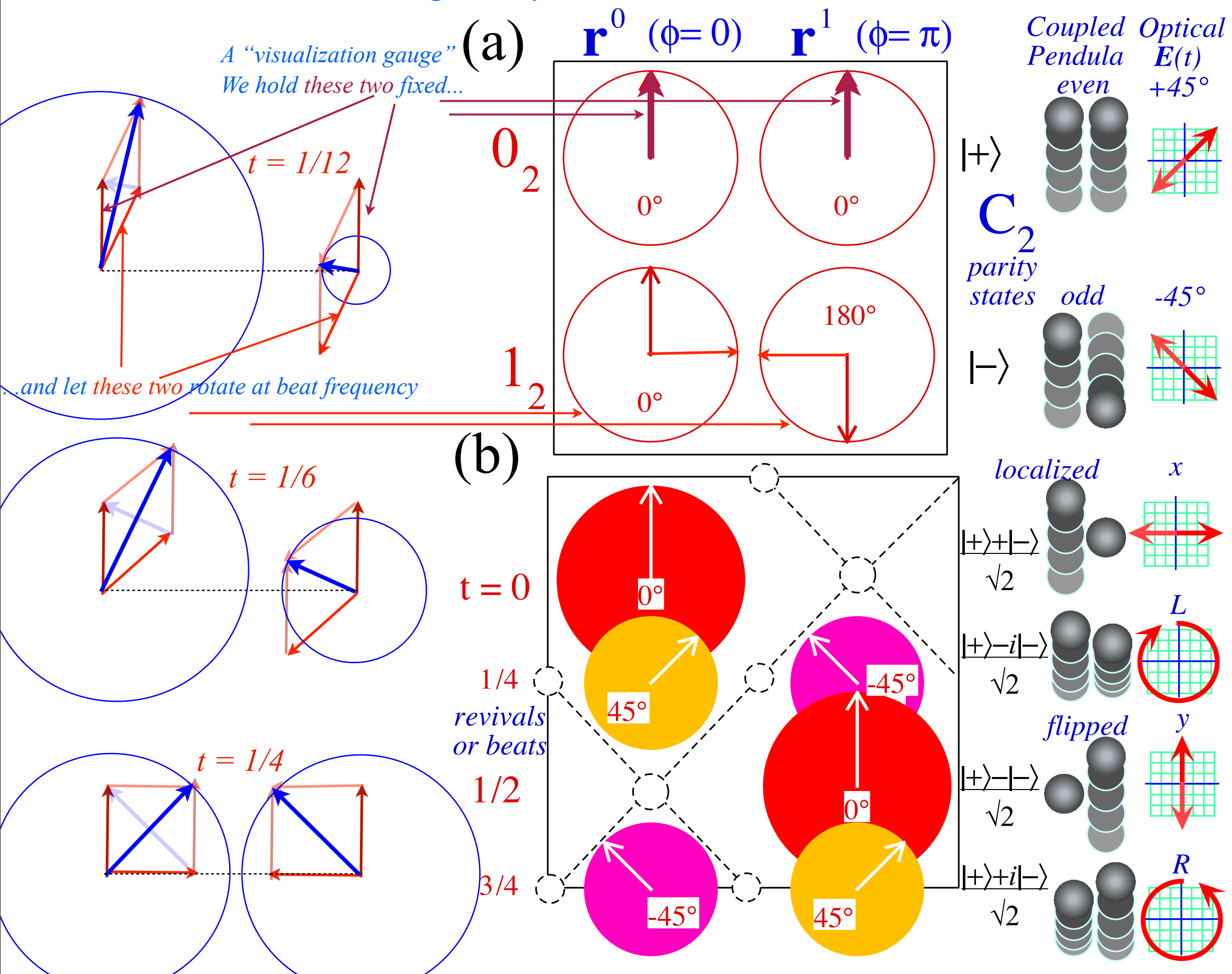
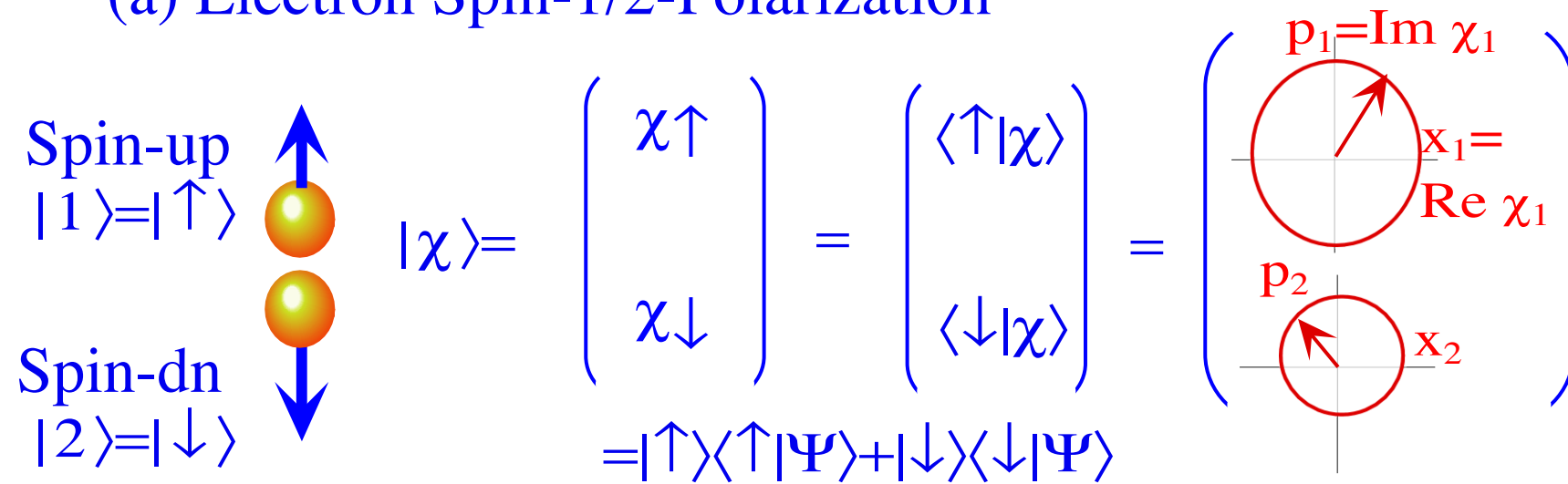

Fig. 3.3.5 Topography lines of potential function $V(x_1, x_2)$ and orthogonal ϵ_+ and ϵ_- normal mode slopes

2D-HO beats and mixed mode geometry



(a) Electron Spin-1/2-Polarization



(b) Photon Spin-1-Polarization

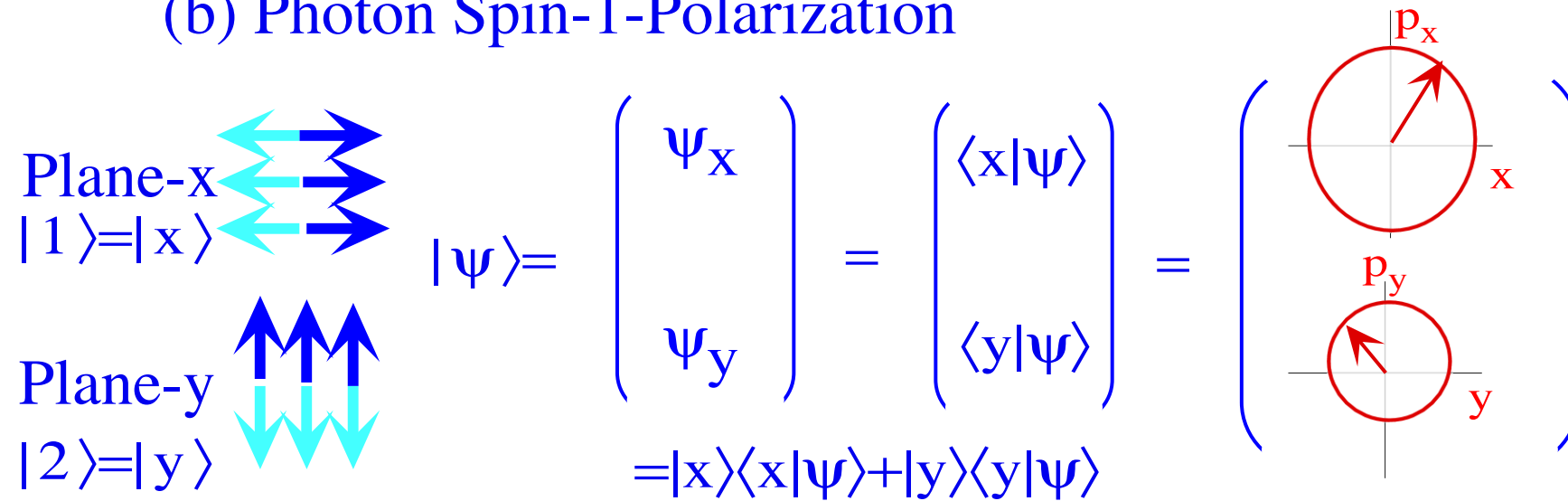

(c) Ammonia (NH₃) Inversion States

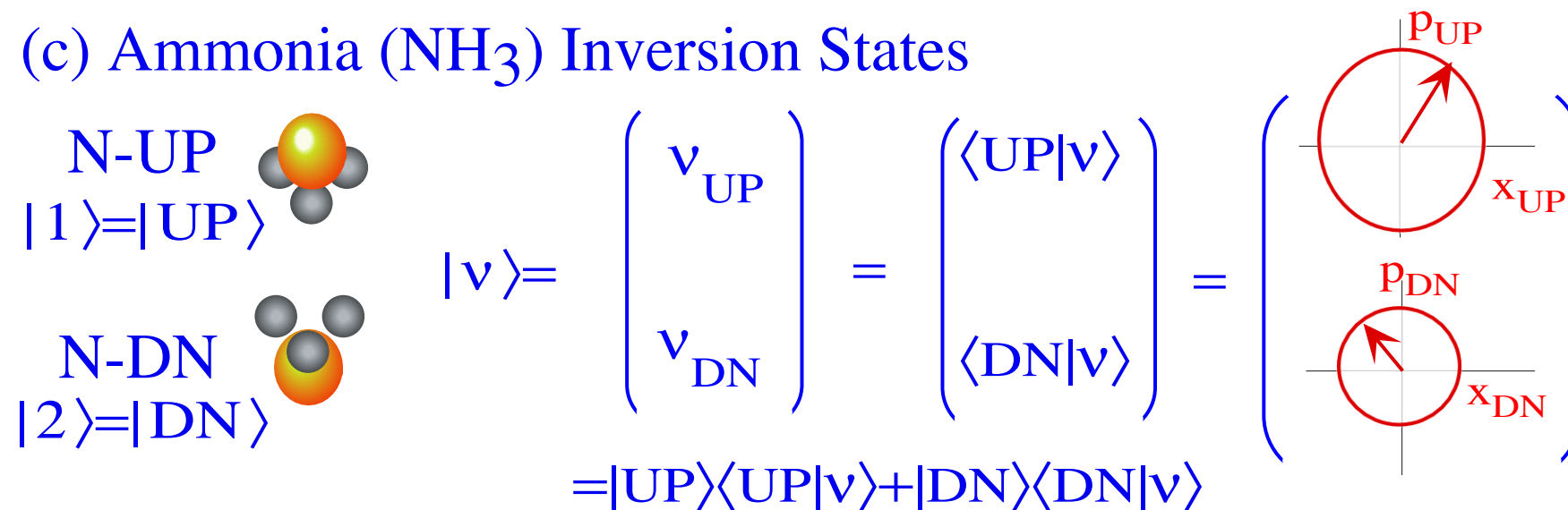



Fig. 10.5.1
QTCA Unit 3 Chapter 10

Review: How C_2 (Bilateral σ_B reflection) symmetry is eigen-solver

 $U(2)$ vs $R(3)$: 2-State Schrodinger: $i\hbar\partial_t|\Psi(t)\rangle = \mathbf{H}|\Psi(t)\rangle$ vs. Classical 2D-HO: $\partial_t^2\mathbf{x} = -\mathbf{K}\cdot\mathbf{x}$
Hamilton-Pauli spinor symmetry (σ -expansion in $ABCD$ -Types) $\mathbf{H} = \omega_\mu\sigma_\mu$

Deriving σ -exponential time evolution (or revolution) operator $\mathbf{U} = e^{-i\mathbf{H}t} = e^{-i\sigma_\mu\omega_\mu t}$

Spinor arithmetic like complex arithmetic

Spinor vector algebra like complex vector algebra

Spinor exponentials like complex exponentials (“Crazy-Thing”-Theorem)

Geometry of $U(2)$ evolution (or $R(3)$ revolution) operator $\mathbf{U} = e^{-i\mathbf{H}t} = e^{-i\sigma_\mu\omega_\mu t}$

The “mysterious” factors of 2 (or 1/2): 2D Spinor vs 3D Spin Vector space

2D Spinor vs 3D vector rotation

NMR Hamiltonian: 3D Spin Moment \mathbf{m} in \mathbf{B} field

Euler’s state definition using rotations $\mathbf{R}(\alpha, 0, 0)$, $\mathbf{R}(0, \beta, 0)$, and $\mathbf{R}(0, 0, \gamma)$

Spin-1 (3D-real vector) case

Spin-1/2 (2D-complex spinor) case

3D-real Stokes Vector defines 2D-HO polarization ellipses and spinor states

Asymmetry $S_A = S_Z$, Balance $S_B = S_X$, and Chirality $S_C = S_Y$

Polarization ellipse and spinor state dynamics

$$U(2) \text{ vs } R(3): 2\text{-State Schrodinger: } i\hbar\partial_t|\Psi(t)\rangle = \mathbf{H}|\Psi(t)\rangle \quad \text{vs.} \quad \text{Classical 2D-HO: } \partial_t^2\mathbf{x} = -\mathbf{K}\cdot\mathbf{x}$$

$$i\hbar|\dot{\Psi}(t)\rangle = \mathbf{H}|\Psi(t)\rangle \quad |\ddot{\mathbf{x}}\rangle = -\mathbf{K}\cdot|\mathbf{x}\rangle$$

First start with 2-by-2 Hermitian (self-conjugate) matrix

$$\mathbf{H} = \begin{pmatrix} A & B-iC \\ B+iC & D \end{pmatrix} = \mathbf{H}^\dagger$$

H_{jk} matrix must obey: $(H_{jk})^* = H_{kj}$

$$U(2) \text{ vs } R(3): 2\text{-State Schrodinger: } i\hbar\partial_t|\Psi(t)\rangle = \mathbf{H}|\Psi(t)\rangle \quad \text{vs.} \quad \text{Classical 2D-HO: } \partial_t^2\mathbf{x} = -\mathbf{K}\cdot\mathbf{x}$$

$$i\hbar|\dot{\Psi}(t)\rangle = \mathbf{H}|\Psi(t)\rangle \quad |\ddot{\mathbf{x}}\rangle = -\mathbf{K}\cdot|\mathbf{x}\rangle$$

First start with 2-by-2 Hermitian (self-conjugate) matrix H_{jk} matrix must obey: $(H_{jk})^* = H_{kj}$

$$\mathbf{H} = \begin{pmatrix} A & B-iC \\ B+iC & D \end{pmatrix} = \mathbf{H}^\dagger$$

that operates on 2-D complex Dirac ket vector $|\Psi\rangle$. Both have 4 parameters

$$|\Psi\rangle = \begin{pmatrix} \Psi_1 \\ \Psi_2 \end{pmatrix} = \begin{pmatrix} x_1 + ip_1 \\ x_2 + ip_2 \end{pmatrix} = \begin{pmatrix} a_1 \\ a_2 \end{pmatrix} \quad (2^2 = 2+2)$$

$$U(2) \text{ vs } R(3): 2\text{-State Schrodinger: } i\hbar\partial_t|\Psi(t)\rangle = \mathbf{H}|\Psi(t)\rangle \quad \text{vs.} \quad \text{Classical 2D-HO: } \partial_t^2\mathbf{x} = -\mathbf{K}\cdot\mathbf{x}$$

$$i\hbar|\dot{\Psi}(t)\rangle = \mathbf{H}|\Psi(t)\rangle \quad |\ddot{\mathbf{x}}\rangle = -\mathbf{K}\cdot|\mathbf{x}\rangle$$

First start with 2-by-2 Hermitian (self-conjugate) matrix H_{jk} matrix must obey: $(H_{jk})^* = H_{kj}$

$$\mathbf{H} = \begin{pmatrix} A & B - iC \\ B + iC & D \end{pmatrix} = \mathbf{H}^\dagger$$

that operates on 2-D complex Dirac ket vector $|\Psi\rangle$. Both have 4 parameters

$$|\Psi\rangle = \begin{pmatrix} \Psi_1 \\ \Psi_2 \end{pmatrix} = \begin{pmatrix} x_1 + ip_1 \\ x_2 + ip_2 \end{pmatrix} = \begin{pmatrix} a_1 \\ a_2 \end{pmatrix} \quad (2^2 = 2+2)$$

Separate real x_k and imaginary p_k parts of Ψ_k amplitudes to convert the complex 1st-order equation $i\partial_t\Psi = \mathbf{H}\Psi$ into pairs of real 1st-order differential equations.

$U(2)$ vs $R(3)$: 2-State Schrodinger: $i\hbar\partial_t|\Psi(t)\rangle = \mathbf{H}|\Psi(t)\rangle$ vs. **Classical 2D-HO: $\partial^2_t\mathbf{x} = -\mathbf{K}\cdot\mathbf{x}$**
 $i\hbar|\dot{\Psi}(t)\rangle = \mathbf{H}|\Psi(t)\rangle$ **$|\ddot{\mathbf{x}}\rangle = -\mathbf{K}\cdot|\mathbf{x}\rangle$**

First start with 2-by-2 Hermitian (self-conjugate) matrix H_{jk} matrix must obey: $(H_{jk})^* = H_{kj}$

$$\mathbf{H} = \begin{pmatrix} A & B - iC \\ B + iC & D \end{pmatrix} = \mathbf{H}^\dagger$$

that operates on 2-D complex Dirac ket vector $|\Psi\rangle$. *Both have 4 parameters ($2^2 = 2+2$)*

$$|\Psi\rangle = \begin{pmatrix} \Psi_1 \\ \Psi_2 \end{pmatrix} = \begin{pmatrix} x_1 + ip_1 \\ x_2 + ip_2 \end{pmatrix} = \begin{pmatrix} a_1 \\ a_2 \end{pmatrix}$$

Separate real x_k and imaginary p_k parts of Ψ_k amplitudes to convert the **complex 1st-order equation $i\partial_t\Psi = \mathbf{H}\Psi$** into pairs of real 1st-order differential equations.

$$i\hbar\frac{\partial}{\partial t}|\Psi(t)\rangle = \mathbf{H}|\Psi(t)\rangle$$

$$i\frac{\partial}{\partial t} \begin{pmatrix} x_1 + ip_1 \\ x_2 + ip_2 \end{pmatrix} = \begin{pmatrix} A & B - iC \\ B + iC & D \end{pmatrix} \begin{pmatrix} x_1 + ip_1 \\ x_2 + ip_2 \end{pmatrix}$$

$U(2)$ vs $R(3)$: 2-State Schrodinger: $i\hbar\partial_t|\Psi(t)\rangle = \mathbf{H}|\Psi(t)\rangle$ vs. **Classical 2D-HO: $\partial^2_t \mathbf{x} = -\mathbf{K} \cdot \mathbf{x}$**
 $i\hbar|\dot{\Psi}(t)\rangle = \mathbf{H}|\Psi(t)\rangle$ **$|\ddot{\mathbf{x}}\rangle = -\mathbf{K} \cdot |\mathbf{x}\rangle$**

First start with 2-by-2 Hermitian (self-conjugate) matrix H_{jk} matrix must obey: $(H_{jk})^* = H_{kj}$

$$\mathbf{H} = \begin{pmatrix} A & B - iC \\ B + iC & D \end{pmatrix} = \mathbf{H}^\dagger$$

that operates on 2-D complex Dirac ket vector $|\Psi\rangle$. *Both have 4 parameters ($2^2 = 2+2$)*

$$|\Psi\rangle = \begin{pmatrix} \Psi_1 \\ \Psi_2 \end{pmatrix} = \begin{pmatrix} x_1 + ip_1 \\ x_2 + ip_2 \end{pmatrix} = \begin{pmatrix} a_1 \\ a_2 \end{pmatrix}$$

Separate real x_k and imaginary p_k parts of Ψ_k amplitudes to convert the complex 1st-order equation $i\partial_t\Psi = \mathbf{H}\Psi$ into pairs of *real* 1st-order differential equations.

$$\begin{aligned} \dot{x}_1 &= Ap_1 + Bp_2 - Cx_2 & \dot{p}_1 &= -Ax_1 - Bx_2 - Cp_2 \\ \dot{x}_2 &= Bp_1 + Dp_2 + Cx_1 & \dot{p}_2 &= -Bx_1 - Dx_2 + Cp_1 \end{aligned}$$

$$i\hbar\frac{\partial}{\partial t}|\Psi(t)\rangle = \mathbf{H}|\Psi(t)\rangle$$

$$i\frac{\partial}{\partial t} \begin{pmatrix} x_1 + ip_1 \\ x_2 + ip_2 \end{pmatrix} = \begin{pmatrix} A & B - iC \\ B + iC & D \end{pmatrix} \begin{pmatrix} x_1 + ip_1 \\ x_2 + ip_2 \end{pmatrix}$$

$$\begin{pmatrix} i\dot{x}_1 - \dot{p}_1 \\ i\dot{x}_2 - \dot{p}_2 \end{pmatrix} = \begin{pmatrix} Ax_1 + Bx_2 + Cp_2 + iAp_1 + iBp_2 - iCx_2 \\ Bx_1 + Dx_2 - Cp_1 + iBp_1 + iDp_2 + iCx_1 \end{pmatrix}$$

$$U(2) \text{ vs } R(3): 2\text{-State Schrodinger: } i\hbar\partial_t|\Psi(t)\rangle = \mathbf{H}|\Psi(t)\rangle \quad \text{vs.} \quad \text{Classical 2D-HO: } \partial^2_t \mathbf{x} = -\mathbf{K} \cdot \mathbf{x}$$

$$i\hbar|\dot{\Psi}(t)\rangle = \mathbf{H}|\Psi(t)\rangle \quad |\ddot{\mathbf{x}}\rangle = -\mathbf{K} \cdot |\mathbf{x}\rangle$$

First start with 2-by-2 Hermitian (self-conjugate) matrix

$$\mathbf{H} = \begin{pmatrix} A & B - iC \\ B + iC & D \end{pmatrix} = \mathbf{H}^\dagger$$

that operates on 2-D complex Dirac ket vector $|\Psi\rangle$.

$$|\Psi\rangle = \begin{pmatrix} \Psi_1 \\ \Psi_2 \end{pmatrix} = \begin{pmatrix} x_1 + ip_1 \\ x_2 + ip_2 \end{pmatrix} = \begin{pmatrix} a_1 \\ a_2 \end{pmatrix}$$

Separate real x_k and imaginary p_k parts of Ψ_k amplitudes to convert the **complex 1st-order equation** $i\partial_t\Psi = \mathbf{H}\Psi$ into pairs of *real* 1st-order differential equations.

$$\begin{aligned} \dot{x}_1 &= Ap_1 + Bp_2 - Cx_2 & \dot{p}_1 &= -Ax_1 - Bx_2 - Cp_2 \\ \dot{x}_2 &= Bp_1 + Dp_2 + Cx_1 & \dot{p}_2 &= -Bx_1 - Dx_2 + Cp_1 \end{aligned}$$

Then start with classical Hamiltonian. (Designed to give same result.)

$$H_c = \frac{A}{2}(p_1^2 + x_1^2) + B(x_1x_2 + p_1p_2) + C(x_1p_2 - x_2p_1) + \frac{D}{2}(p_2^2 + x_2^2)$$

$$U(2) \text{ vs } R(3): 2\text{-State Schrodinger: } i\hbar\partial_t|\Psi(t)\rangle = \mathbf{H}|\Psi(t)\rangle \quad \text{vs.} \quad \text{Classical 2D-HO: } \partial^2_t \mathbf{x} = -\mathbf{K} \cdot \mathbf{x}$$

$$i\hbar|\dot{\Psi}(t)\rangle = \mathbf{H}|\Psi(t)\rangle \quad |\ddot{\mathbf{x}}\rangle = -\mathbf{K} \cdot |\mathbf{x}\rangle$$

First start with 2-by-2 Hermitian (self-conjugate) matrix

$$\mathbf{H} = \begin{pmatrix} A & B - iC \\ B + iC & D \end{pmatrix} = \mathbf{H}^\dagger$$

that operates on 2-D complex Dirac ket vector $|\Psi\rangle$.

$$|\Psi\rangle = \begin{pmatrix} \Psi_1 \\ \Psi_2 \end{pmatrix} = \begin{pmatrix} x_1 + ip_1 \\ x_2 + ip_2 \end{pmatrix} = \begin{pmatrix} a_1 \\ a_2 \end{pmatrix}$$

Separate real x_k and imaginary p_k parts of Ψ_k amplitudes to convert the complex 1st-order equation $i\partial_t\Psi = \mathbf{H}\Psi$ into pairs of *real* 1st-order differential equations.

$$\dot{x}_1 = Ap_1 + Bp_2 - Cx_2 \quad \dot{p}_1 = -Ax_1 - Bx_2 - Cp_2$$

$$\dot{x}_2 = Bp_1 + Dp_2 + Cx_1 \quad \dot{p}_2 = -Bx_1 - Dx_2 + Cp_1$$

Then start with classical Hamiltonian. (Designed to give same result.)

$$H_c = \frac{A}{2}(p_1^2 + x_1^2) + B(x_1x_2 + p_1p_2) + C(x_1p_2 - x_2p_1) + \frac{D}{2}(p_2^2 + x_2^2)$$

Then Hamilton's equations of motion are the following.

$$\dot{x}_1 = \frac{\partial H_c}{\partial p_1} = Ap_1 + Bp_2 - Cx_2 \quad \dot{p}_1 = -\frac{\partial H_c}{\partial x_1} = -(Ax_1 + Bx_2 + Cp_2)$$

$$\dot{x}_2 = \frac{\partial H_c}{\partial p_2} = Bp_1 + Dp_2 + Cx_1 \quad \dot{p}_2 = -\frac{\partial H_c}{\partial x_2} = -(Bx_1 + Dx_2 - Cp_1)$$

$$U(2) \text{ vs } R(3): 2\text{-State Schrodinger: } i\hbar\partial_t|\Psi(t)\rangle = \mathbf{H}|\Psi(t)\rangle \quad \text{vs.} \quad \text{Classical 2D-HO: } \partial^2_t \mathbf{x} = -\mathbf{K} \cdot \mathbf{x}$$

$$i\hbar|\dot{\Psi}(t)\rangle = \mathbf{H}|\Psi(t)\rangle \quad \quad \quad |\ddot{\mathbf{x}}\rangle = -\mathbf{K} \cdot |\mathbf{x}\rangle$$

First start with 2-by-2 Hermitian (self-conjugate) matrix

$$\mathbf{H} = \begin{pmatrix} A & B - iC \\ B + iC & D \end{pmatrix} = \mathbf{H}^\dagger$$

that operates on 2-D complex Dirac ket vector $|\Psi\rangle$.

$$|\Psi\rangle = \begin{pmatrix} \Psi_1 \\ \Psi_2 \end{pmatrix} = \begin{pmatrix} x_1 + ip_1 \\ x_2 + ip_2 \end{pmatrix} = \begin{pmatrix} a_1 \\ a_2 \end{pmatrix}$$

Separate real x_k and imaginary p_k parts of Ψ_k amplitudes

to convert the **complex 1st-order equation** $i\partial_t\Psi = \mathbf{H}\Psi$

into pairs of **real 1st-order differential equations**.

$$\dot{x}_1 = Ap_1 + Bp_2 - Cx_2 \quad \dot{p}_1 = -Ax_1 - Bx_2 - Cp_2$$

$$\dot{x}_2 = Bp_1 + Dp_2 + Cx_1 \quad \dot{p}_2 = -Bx_1 - Dx_2 + Cp_1$$

*QM vs. Classical
Equations are
identical*

Then start with classical Hamiltonian. (Designed to give same result.)

$$H_c = \frac{A}{2}(p_1^2 + x_1^2) + B(x_1x_2 + p_1p_2) + C(x_1p_2 - x_2p_1) + \frac{D}{2}(p_2^2 + x_2^2)$$

Then Hamilton's equations of motion are the following.

$$\dot{x}_1 = \frac{\partial H_c}{\partial p_1} = Ap_1 + Bp_2 - Cx_2 \quad \dot{p}_1 = -\frac{\partial H_c}{\partial x_1} = -(Ax_1 + Bx_2 + Cp_2)$$

$$\dot{x}_2 = \frac{\partial H_c}{\partial p_2} = Bp_1 + Dp_2 + Cx_1 \quad \dot{p}_2 = -\frac{\partial H_c}{\partial x_2} = -(Bx_1 + Dx_2 - Cp_1)$$

$U(2)$ vs $R(3)$: 2-State Schrodinger: $i\hbar\partial_t|\Psi(t)\rangle = \mathbf{H}|\Psi(t)\rangle$
 $i\hbar|\dot{\Psi}(t)\rangle = \mathbf{H}|\Psi(t)\rangle$

vs. Classical 2D-HO: $\partial^2_t \mathbf{x} = -\mathbf{K} \cdot \mathbf{x}$
 $|\ddot{\mathbf{x}}\rangle = -\mathbf{K} \cdot |\mathbf{x}\rangle$

First start with 2-by-2 Hermitian (self-conjugate) matrix

$$\mathbf{H} = \begin{pmatrix} A & B - iC \\ B + iC & D \end{pmatrix} = \mathbf{H}^\dagger$$

that operates on 2-D complex Dirac ket vector $|\Psi\rangle$.

$$|\Psi\rangle = \begin{pmatrix} \Psi_1 \\ \Psi_2 \end{pmatrix} = \begin{pmatrix} x_1 + ip_1 \\ x_2 + ip_2 \end{pmatrix} = \begin{pmatrix} a_1 \\ a_2 \end{pmatrix}$$

Separate real x_k and imaginary p_k parts of Ψ_k amplitudes to convert the complex 1st-order equation $i\partial_t\Psi = \mathbf{H}\Psi$ into pairs of *real* 1st-order differential equations.

$$\begin{cases} \dot{x}_1 = Ap_1 + Bp_2 - Cx_2 \\ \dot{x}_2 = Bp_1 + Dp_2 + Cx_1 \end{cases} \quad \begin{cases} \dot{p}_1 = -Ax_1 - Bx_2 - Cp_2 \\ \dot{p}_2 = -Bx_1 - Dx_2 + Cp_1 \end{cases}$$

QM vs. Classical Equations are identical

Then start with classical Hamiltonian. (Designed to give same result.)

$$H_c = \frac{A}{2}(p_1^2 + x_1^2) + B(x_1x_2 + p_1p_2) + C(x_1p_2 - x_2p_1) + \frac{D}{2}(p_2^2 + x_2^2)$$

Then Hamilton's equations of motion are the following.

$$\begin{aligned} \dot{x}_1 &= \frac{\partial H_c}{\partial p_1} = Ap_1 + Bp_2 - Cx_2 & \dot{p}_1 &= -\frac{\partial H_c}{\partial x_1} = -(Ax_1 + Bx_2 + Cp_2) \\ \dot{x}_2 &= \frac{\partial H_c}{\partial p_2} = Bp_1 + Dp_2 + Cx_1 & \dot{p}_2 &= -\frac{\partial H_c}{\partial x_2} = -(Bx_1 + Dx_2 - Cp_1) \end{aligned}$$

Finally a 2nd time derivative (Assume constant A, B, D , and *let* $C=0$) gives 2nd-order classical Newton-Hooke-like equation: $|\ddot{\mathbf{x}}\rangle = -\mathbf{K} \cdot |\mathbf{x}\rangle$

$$\begin{aligned} \ddot{x}_1 &= A\dot{p}_1 + B\dot{p}_2 - C\dot{x}_2 \\ &= -A(Ax_1 + Bx_2 + Cp_2) - B(Bx_1 + Dx_2 - Cp_1) - C(Bp_1 + Dp_2 + Cx_1) \\ &= -(A^2 + B^2 + C^2)x_1 - (AB + BD)x_2 - C(A + D)p_2 \end{aligned}$$

$$\begin{aligned} \ddot{x}_2 &= B\dot{p}_1 + D\dot{p}_2 + C\dot{x}_1 \\ &= -B(Ax_1 + Bx_2 + Cp_2) - D(Bx_1 + Dx_2 - Cp_1) + C(Ap_1 + Bp_2 - Cx_2) \\ &= -(AB + BD)x_1 - (B^2 + D^2 + C^2)x_2 + C(A + D)p_1 \end{aligned}$$

$U(2)$ vs $R(3)$: 2-State Schrodinger: $i\hbar\partial_t|\Psi(t)\rangle = \mathbf{H}|\Psi(t)\rangle$

vs. **Classical 2D-HO:** $\partial_t^2\mathbf{x} = -\mathbf{K}\cdot\mathbf{x}$

$$i\hbar|\dot{\Psi}(t)\rangle = \mathbf{H}|\Psi(t)\rangle$$

$$|\ddot{\mathbf{x}}\rangle = -\mathbf{K}\cdot|\mathbf{x}\rangle$$

First start with 2-by-2 Hermitian (self-conjugate) matrix

$$\mathbf{H} = \begin{pmatrix} A & B-iC \\ B+iC & D \end{pmatrix} = \mathbf{H}^\dagger$$

that operates on 2-D complex Dirac ket vector $|\Psi\rangle$.

$$|\Psi\rangle = \begin{pmatrix} \Psi_1 \\ \Psi_2 \end{pmatrix} = \begin{pmatrix} x_1 + ip_1 \\ x_2 + ip_2 \end{pmatrix} = \begin{pmatrix} a_1 \\ a_2 \end{pmatrix}$$

Separate real x_k and imaginary p_k parts of Ψ_k amplitudes

to convert the **complex 1st-order equation** $i\partial_t\Psi = \mathbf{H}\Psi$

into pairs of **real 1st-order** differential equations.

$$\begin{cases} \dot{x}_1 = Ap_1 + Bp_2 - Cx_2 \\ \dot{x}_2 = Bp_1 + Dp_2 + Cx_1 \end{cases} \quad \begin{cases} \dot{p}_1 = -Ax_1 - Bx_2 - Cp_2 \\ \dot{p}_2 = -Bx_1 - Dx_2 + Cp_1 \end{cases}$$

QM vs. Classical Equations are identical

$$\begin{aligned} \dot{x}_1 &= \frac{\partial H_c}{\partial p_1} = Ap_1 + Bp_2 - Cx_2 & \dot{p}_1 &= -\frac{\partial H_c}{\partial x_1} = -(Ax_1 + Bx_2 + Cp_2) \\ \dot{x}_2 &= \frac{\partial H_c}{\partial p_2} = Bp_1 + Dp_2 + Cx_1 & \dot{p}_2 &= -\frac{\partial H_c}{\partial x_2} = -(Bx_1 + Dx_2 - Cp_1) \end{aligned}$$

Finally a 2nd time derivative (Assume *constant* A, B, D , and **let $C=0$**) gives 2nd-order classical Newton-Hooke-like equation: $|\ddot{\mathbf{x}}\rangle = -\mathbf{K}\cdot|\mathbf{x}\rangle$

$$\begin{aligned} \ddot{x}_1 &= A\dot{p}_1 + B\dot{p}_2 - C\dot{x}_2 \\ &= -A(Ax_1 + Bx_2 + Cp_2) - B(Bx_1 + Dx_2 - Cp_1) - C(Bp_1 + Dp_2 + Cx_1) \\ &= -(A^2 + B^2 + C^2)x_1 - (AB + BD)x_2 - C(A + D)p_2 \end{aligned}$$

$$\begin{aligned} \ddot{x}_2 &= B\dot{p}_1 + D\dot{p}_2 + C\dot{x}_1 \\ &= -B(Ax_1 + Bx_2 + Cp_2) - D(Bx_1 + Dx_2 - Cp_1) + C(Ap_1 + Bp_2 - Cx_2) \\ &= -(AB + BD)x_1 - (B^2 + D^2 + C^2)x_2 + C(A + D)p_1 \end{aligned}$$

$$\begin{pmatrix} \ddot{x}_1 \\ \ddot{x}_2 \end{pmatrix} = -\begin{pmatrix} A^2 + B^2 & AB + BD \\ AB + BD & B^2 + D^2 \end{pmatrix} \begin{pmatrix} x_1 \\ x_2 \end{pmatrix}$$

For $C=0$ Is form of 2D Hooke harmonic oscillator

$$\frac{\partial^2}{\partial t^2} \begin{pmatrix} x_1 \\ x_2 \end{pmatrix} \equiv \begin{pmatrix} \ddot{x}_1 \\ \ddot{x}_2 \end{pmatrix} = -\begin{pmatrix} K_{11} & K_{12} \\ K_{21} & K_{22} \end{pmatrix} \begin{pmatrix} x_1 \\ x_2 \end{pmatrix}$$

Then start with classical Hamiltonian. (Designed to give same result.)

$$H_c = \frac{A}{2}(p_1^2 + x_1^2) + B(x_1x_2 + p_1p_2) + C(x_1p_2 - x_2p_1) + \frac{D}{2}(p_2^2 + x_2^2)$$

Then Hamilton's equations of motion are the following.

$$U(2) \text{ vs } R(3): 2\text{-State Schrodinger: } i\hbar\partial_t|\Psi(t)\rangle = \mathbf{H}|\Psi(t)\rangle \quad \text{vs.} \quad \text{Classical 2D-HO: } \partial_t^2\mathbf{x} = -\mathbf{K}\cdot\mathbf{x}$$

$$i\hbar|\dot{\Psi}(t)\rangle = \mathbf{H}|\Psi(t)\rangle \quad |\ddot{\mathbf{x}}\rangle = -\mathbf{K}\cdot|\mathbf{x}\rangle$$

First start with 2-by-2 Hermitian (self-conjugate) matrix

$$\mathbf{H} = \begin{pmatrix} A & B-iC \\ B+iC & D \end{pmatrix} = \mathbf{H}^\dagger$$

that operates on 2-D complex Dirac ket vector $|\Psi\rangle$.

$$|\Psi\rangle = \begin{pmatrix} \Psi_1 \\ \Psi_2 \end{pmatrix} = \begin{pmatrix} x_1 + ip_1 \\ x_2 + ip_2 \end{pmatrix} = \begin{pmatrix} a_1 \\ a_2 \end{pmatrix}$$

Separate real x_k and imaginary p_k parts of Ψ_k amplitudes to convert the complex 1st-order equation $i\partial_t\Psi = \mathbf{H}\Psi$ into pairs of *real* 1st-order differential equations.

$$\begin{cases} \dot{x}_1 = Ap_1 + Bp_2 - Cx_2 \\ \dot{x}_2 = Bp_1 + Dp_2 + Cx_1 \end{cases} \quad \begin{cases} \dot{p}_1 = -Ax_1 - Bx_2 - Cp_2 \\ \dot{p}_2 = -Bx_1 - Dx_2 + Cp_1 \end{cases}$$

QM vs. Classical Equations are identical

$$\begin{cases} \dot{x}_1 = \frac{\partial H_c}{\partial p_1} = Ap_1 + Bp_2 - Cx_2 \\ \dot{x}_2 = \frac{\partial H_c}{\partial p_2} = Bp_1 + Dp_2 + Cx_1 \end{cases} \quad \begin{cases} \dot{p}_1 = -\frac{\partial H_c}{\partial x_1} = -(Ax_1 + Bx_2 + Cp_2) \\ \dot{p}_2 = -\frac{\partial H_c}{\partial x_2} = -(Bx_1 + Dx_2 - Cp_1) \end{cases}$$

Finally a 2nd time derivative (Assume constant A, B, D , and *let $C=0$*) gives 2nd-order classical Newton-Hooke-like equation: $|\ddot{\mathbf{x}}\rangle = -\mathbf{K}\cdot|\mathbf{x}\rangle$

$$\begin{aligned} \ddot{x}_1 &= A\dot{p}_1 + B\dot{p}_2 - C\dot{x}_2 \\ &= -A(Ax_1 + Bx_2 + Cp_2) - B(Bx_1 + Dx_2 - Cp_1) - C(Bp_1 + Dp_2 + Cx_1) \\ &= -(A^2 + B^2 + C^2)x_1 - (AB + BD)x_2 - C(A + D)p_2 \end{aligned}$$

$$\begin{aligned} \ddot{x}_2 &= B\dot{p}_1 + D\dot{p}_2 + C\dot{x}_1 \\ &= -B(Ax_1 + Bx_2 + Cp_2) - D(Bx_1 + Dx_2 - Cp_1) + C(Ap_1 + Bp_2 - Cx_2) \\ &= -(AB + BD)x_1 - (B^2 + D^2 + C^2)x_2 + C(A + D)p_1 \end{aligned}$$

$$\begin{pmatrix} \ddot{x}_1 \\ \ddot{x}_2 \end{pmatrix} = -\begin{pmatrix} A^2 + B^2 & AB + BD \\ AB + BD & B^2 + D^2 \end{pmatrix} \begin{pmatrix} x_1 \\ x_2 \end{pmatrix}$$

For $C=0$ Is form of 2D Hooke harmonic oscillator

$$\frac{\partial^2}{\partial t^2} \begin{pmatrix} x_1 \\ x_2 \end{pmatrix} \equiv \begin{pmatrix} \ddot{x}_1 \\ \ddot{x}_2 \end{pmatrix} = -\begin{pmatrix} K_{11} & K_{12} \\ K_{21} & K_{22} \end{pmatrix} \begin{pmatrix} x_1 \\ x_2 \end{pmatrix}$$

Here is an operator view of the QM-Classical connection: Take Schrodinger operator $i\partial_t = \mathbf{H}$ (with $C=0$) and square it!

$$i\frac{\partial}{\partial t} = \begin{pmatrix} A & B \\ B & D \end{pmatrix} \Rightarrow \left(i\frac{\partial}{\partial t}\right)^2 = \begin{pmatrix} A & B \\ B & D \end{pmatrix}^2 \Rightarrow -\frac{\partial^2}{\partial t^2} = \begin{pmatrix} A^2 + B^2 & AB + BD \\ AB + BD & B^2 + D^2 \end{pmatrix}$$

$$U(2) \text{ vs } R(3): 2\text{-State Schrodinger: } i\hbar\partial_t|\Psi(t)\rangle = \mathbf{H}|\Psi(t)\rangle \quad \text{vs.} \quad \text{Classical 2D-HO: } \partial_t^2\mathbf{x} = -\mathbf{K}\cdot\mathbf{x}$$

$$i\hbar|\dot{\Psi}(t)\rangle = \mathbf{H}|\Psi(t)\rangle \quad \quad \quad |\ddot{\mathbf{x}}\rangle = -\mathbf{K}\cdot|\mathbf{x}\rangle$$

First start with 2-by-2 Hermitian (self-conjugate) matrix

$$\mathbf{H} = \begin{pmatrix} A & B - iC \\ B + iC & D \end{pmatrix} = \mathbf{H}^\dagger$$

that operates on 2-D complex Dirac ket vector $|\Psi\rangle$.

$$|\Psi\rangle = \begin{pmatrix} \Psi_1 \\ \Psi_2 \end{pmatrix} = \begin{pmatrix} x_1 + ip_1 \\ x_2 + ip_2 \end{pmatrix} = \begin{pmatrix} a_1 \\ a_2 \end{pmatrix}$$

Separate real x_k and imaginary p_k parts of Ψ_k amplitudes to convert the complex 1st-order equation $i\partial_t\Psi = \mathbf{H}\Psi$ into pairs of *real* 1st-order differential equations.

$$\begin{cases} \dot{x}_1 = Ap_1 + Bp_2 - Cx_2 \\ \dot{x}_2 = Bp_1 + Dp_2 + Cx_1 \end{cases} \quad \begin{cases} \dot{p}_1 = -Ax_1 - Bx_2 - Cp_2 \\ \dot{p}_2 = -Bx_1 - Dx_2 + Cp_1 \end{cases}$$

QM vs. Classical Equations are identical

Then start with classical Hamiltonian. (Designed to give same result.)

$$H_c = \frac{A}{2}(p_1^2 + x_1^2) + B(x_1x_2 + p_1p_2) + C(x_1p_2 - x_2p_1) + \frac{D}{2}(p_2^2 + x_2^2)$$

Then Hamilton's equations of motion are the following.

$$\begin{aligned} \dot{x}_1 &= \frac{\partial H_c}{\partial p_1} = Ap_1 + Bp_2 - Cx_2 & \dot{p}_1 &= -\frac{\partial H_c}{\partial x_1} = -(Ax_1 + Bx_2 + Cp_2) \\ \dot{x}_2 &= \frac{\partial H_c}{\partial p_2} = Bp_1 + Dp_2 + Cx_1 & \dot{p}_2 &= -\frac{\partial H_c}{\partial x_2} = -(Bx_1 + Dx_2 - Cp_1) \end{aligned}$$

Finally a 2nd time derivative (Assume constant A, B, D , and *let $C=0$*) gives 2nd-order classical Newton-Hooke-like equation: $|\ddot{\mathbf{x}}\rangle = -\mathbf{K}\cdot|\mathbf{x}\rangle$

$$\begin{aligned} \ddot{x}_1 &= A\dot{p}_1 + B\dot{p}_2 - C\dot{x}_2 \\ &= -A(Ax_1 + Bx_2 + Cp_2) - B(Bx_1 + Dx_2 - Cp_1) - C(Bp_1 + Dp_2 + Cx_1) \\ &= -(A^2 + B^2 + C^2)x_1 - (AB + BD)x_2 - C(A + D)p_2 \end{aligned}$$

$$\begin{aligned} \ddot{x}_2 &= B\dot{p}_1 + D\dot{p}_2 + C\dot{x}_1 \\ &= -B(Ax_1 + Bx_2 + Cp_2) - D(Bx_1 + Dx_2 - Cp_1) + C(Ap_1 + Bp_2 - Cx_2) \\ &= -(AB + BD)x_1 - (B^2 + D^2 + C^2)x_2 + C(A + D)p_1 \end{aligned}$$

$$\begin{pmatrix} \ddot{x}_1 \\ \ddot{x}_2 \end{pmatrix} = -\begin{pmatrix} A^2 + B^2 & AB + BD \\ AB + BD & B^2 + D^2 \end{pmatrix} \begin{pmatrix} x_1 \\ x_2 \end{pmatrix}$$

For $C=0$ Is form of 2D Hooke harmonic oscillator

$$\frac{\partial^2}{\partial t^2} \begin{pmatrix} x_1 \\ x_2 \end{pmatrix} \equiv \begin{pmatrix} \ddot{x}_1 \\ \ddot{x}_2 \end{pmatrix} = -\begin{pmatrix} K_{11} & K_{12} \\ K_{21} & K_{22} \end{pmatrix} \begin{pmatrix} x_1 \\ x_2 \end{pmatrix}$$

Here is an operator view of the QM-Classical connection: Take Schrodinger operator $i\partial_t = \mathbf{H}$ (with $C=0$) and square it!

$$i\frac{\partial}{\partial t} = \begin{pmatrix} A & B \\ B & D \end{pmatrix} \Rightarrow \left(i\frac{\partial}{\partial t}\right)^2 = \begin{pmatrix} A & B \\ B & D \end{pmatrix}^2 \Rightarrow -\frac{\partial^2}{\partial t^2} = \begin{pmatrix} A^2 + B^2 & AB + BD \\ AB + BD & B^2 + D^2 \end{pmatrix}$$

Conclusion: 2-state Schro-equation $i\hbar\frac{\partial}{\partial t}|\Psi(t)\rangle = \mathbf{H}|\Psi(t)\rangle$ is like "square-root" of Newton-Hooke. $\sqrt{|\ddot{\mathbf{x}}\rangle = -\mathbf{K}\cdot|\mathbf{x}\rangle}$

$$\begin{pmatrix} \ddot{x}_1 \\ \ddot{x}_2 \end{pmatrix} = - \begin{pmatrix} A^2 + B^2 & AB + BD \\ AB + BD & B^2 + D^2 \end{pmatrix} \begin{pmatrix} x_1 \\ x_2 \end{pmatrix} \quad \text{For } C=0 \\ \text{Is form of 2D Hooke} \\ \text{harmonic oscillator} \quad \frac{\partial^2}{\partial t^2} \begin{pmatrix} x_1 \\ x_2 \end{pmatrix} \equiv \begin{pmatrix} \ddot{x}_1 \\ \ddot{x}_2 \end{pmatrix} = - \begin{pmatrix} K_{11} & K_{12} \\ K_{21} & K_{22} \end{pmatrix} \begin{pmatrix} x_1 \\ x_2 \end{pmatrix}$$

Here is an operator view of the QM-Classical connection: Take Schrodinger operator $i\partial_t = \mathbf{H}$ (with $C=0$) and square it!

$$i\frac{\partial}{\partial t} = \begin{pmatrix} A & B \\ B & D \end{pmatrix} \Rightarrow \left(i\frac{\partial}{\partial t}\right)^2 = \begin{pmatrix} A & B \\ B & D \end{pmatrix}^2 \Rightarrow -\frac{\partial^2}{\partial t^2} = \begin{pmatrix} A^2 + B^2 & AB + BD \\ AB + BD & B^2 + D^2 \end{pmatrix}$$

Conclusion: 2-state Schro-equation $i\hbar\frac{\partial}{\partial t}|\Psi(t)\rangle = \mathbf{H}|\Psi(t)\rangle$ is like “square-root” of Newton-Hooke. $\sqrt{|\ddot{\mathbf{x}}\rangle = -\mathbf{K}\cdot|\mathbf{x}\rangle}$

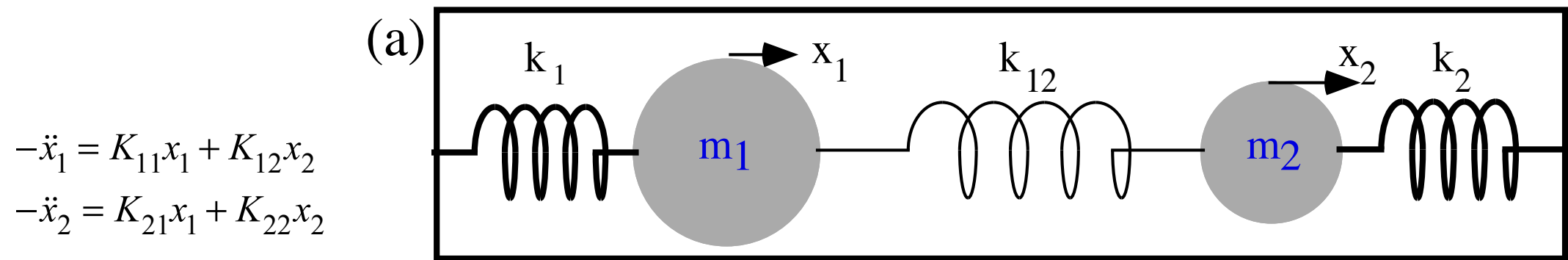

$$m_1 K_{11} = A^2 + B^2 = k_1 + k_{12}, \quad m_1 K_{12} = AB + BD = -k_{12},$$

$$m_2 K_{21} = AB + BD = -k_{12}, \quad m_2 K_{22} = B^2 + D^2 = k_2 + k_{12}.$$

Review: How C_2 (Bilateral σ_B reflection) symmetry is eigen-solver

 $U(2)$ vs $R(3)$: 2-State Schrodinger: $i\hbar\partial_t|\Psi(t)\rangle = \mathbf{H}|\Psi(t)\rangle$ vs. Classical 2D-HO: $\partial_t^2\mathbf{x} = -\mathbf{K}\cdot\mathbf{x}$
Hamilton-Pauli spinor symmetry (σ -expansion in ABCD-Types) $\mathbf{H} = \omega_\mu\sigma_\mu$

Deriving σ -exponential time evolution (or revolution) operator $\mathbf{U} = e^{-i\mathbf{H}t} = e^{-i\sigma_\mu\omega_\mu t}$

Spinor arithmetic like complex arithmetic

Spinor vector algebra like complex vector algebra

Spinor exponentials like complex exponentials ("Crazy-Thing"-Theorem)

Geometry of $U(2)$ evolution (or $R(3)$ revolution) operator $\mathbf{U} = e^{-i\mathbf{H}t} = e^{-i\sigma_\mu\omega_\mu t}$

The "mysterious" factors of 2 (or 1/2): 2D Spinor vs 3D Spin Vector space

2D Spinor vs 3D vector rotation

NMR Hamiltonian: 3D Spin Moment \mathbf{m} in \mathbf{B} field

Euler's state definition using rotations $\mathbf{R}(\alpha, 0, 0)$, $\mathbf{R}(0, \beta, 0)$, and $\mathbf{R}(0, 0, \gamma)$

Spin-1 (3D-real vector) case

Spin-1/2 (2D-complex spinor) case

3D-real Stokes Vector defines 2D-HO polarization ellipses and spinor states

Asymmetry $S_A = S_Z$, Balance $S_B = S_X$, and Chirality $S_C = S_Y$

Polarization ellipse and spinor state dynamics

ABCD Symmetry operator analysis and U(2) spinors

Decompose the Hamiltonian operator \mathbf{H} into four *ABCD symmetry operators*

(Labeled to provide dynamic mnemonics as well as colorful analogies)

$$\begin{aligned} \begin{pmatrix} A & B-iC \\ B+iC & D \end{pmatrix} &= A \begin{pmatrix} 1 & 0 \\ 0 & 0 \end{pmatrix} + B \begin{pmatrix} 0 & 1 \\ 1 & 0 \end{pmatrix} + C \begin{pmatrix} 0 & -i \\ i & 0 \end{pmatrix} + D \begin{pmatrix} 0 & 0 \\ 0 & 1 \end{pmatrix} = A\mathbf{e}_{11} + B\boldsymbol{\sigma}_B + C\boldsymbol{\sigma}_C + D\mathbf{e}_{22} \\ &= \frac{A-D}{2} \begin{pmatrix} 1 & 0 \\ 0 & -1 \end{pmatrix} + B \begin{pmatrix} 0 & 1 \\ 1 & 0 \end{pmatrix} + C \begin{pmatrix} 0 & -i \\ i & 0 \end{pmatrix} + \frac{A+D}{2} \begin{pmatrix} 1 & 0 \\ 0 & 1 \end{pmatrix} \\ \mathbf{H} &= \frac{A-D}{2} \boldsymbol{\sigma}_A + B \boldsymbol{\sigma}_B + C \boldsymbol{\sigma}_C + \frac{A+D}{2} \boldsymbol{\sigma}_0 \end{aligned}$$

Symmetry archetypes: *A (Asymmetric-diagonal)* | *B (Bilateral-balanced)* | *C (complex, circular, chiral, cyclotron, ...)*

ABCD Symmetry operator analysis and U(2) spinors

Decompose the Hamiltonian operator \mathbf{H} into four *ABCD symmetry operators*

(Labeled to provide dynamic mnemonics as well as colorful analogies)

$$\begin{aligned} \begin{pmatrix} A & B-iC \\ B+iC & D \end{pmatrix} &= A \begin{pmatrix} 1 & 0 \\ 0 & 0 \end{pmatrix} + B \begin{pmatrix} 0 & 1 \\ 1 & 0 \end{pmatrix} + C \begin{pmatrix} 0 & -i \\ i & 0 \end{pmatrix} + D \begin{pmatrix} 0 & 0 \\ 0 & 1 \end{pmatrix} = A\mathbf{e}_{11} + B\sigma_B + C\sigma_C + D\mathbf{e}_{22} \\ &= \frac{A-D}{2} \begin{pmatrix} 1 & 0 \\ 0 & -1 \end{pmatrix} + B \begin{pmatrix} 0 & 1 \\ 1 & 0 \end{pmatrix} + C \begin{pmatrix} 0 & -i \\ i & 0 \end{pmatrix} + \frac{A+D}{2} \begin{pmatrix} 1 & 0 \\ 0 & 1 \end{pmatrix} \\ \mathbf{H} &= \frac{A-D}{2} \sigma_A + B \sigma_B + C \sigma_C + \frac{A+D}{2} \sigma_0 \end{aligned}$$

Symmetry archetypes: *A (Asymmetric-diagonal) | B (Bilateral-balanced) | C (complex, circular, chiral, cyclotron, Coriolis, centrifugal,*

curly, and circulating-current-carrying...)

Motivation for coloring scheme:
The Traffic Signal

Standing waves



Moving waves

ABCD Symmetry operator analysis and U(2) spinors

Decompose the Hamiltonian operator \mathbf{H} into four *ABCD symmetry operators*

(Labeled to provide dynamic mnemonics as well as colorful analogies)

$$\begin{pmatrix} A & B-iC \\ B+iC & D \end{pmatrix} = A \begin{pmatrix} 1 & 0 \\ 0 & 0 \end{pmatrix} + B \begin{pmatrix} 0 & 1 \\ 1 & 0 \end{pmatrix} + C \begin{pmatrix} 0 & -i \\ i & 0 \end{pmatrix} + D \begin{pmatrix} 0 & 0 \\ 0 & 1 \end{pmatrix} = A\mathbf{e}_{11} + B\sigma_B + C\sigma_C + D\mathbf{e}_{22}$$

$$= \frac{A-D}{2} \begin{pmatrix} 1 & 0 \\ 0 & -1 \end{pmatrix} + B \begin{pmatrix} 0 & 1 \\ 1 & 0 \end{pmatrix} + C \begin{pmatrix} 0 & -i \\ i & 0 \end{pmatrix} + \frac{A+D}{2} \begin{pmatrix} 1 & 0 \\ 0 & 1 \end{pmatrix}$$

$$\mathbf{H} = \frac{A-D}{2} \sigma_A + B \sigma_B + C \sigma_C + \frac{A+D}{2} \sigma_0$$

Symmetry archetypes: *A (Asymmetric-diagonal) | B (Bilateral-balanced) | C (complex, circular, chiral, cyclotron, Coriolis, centrifugal, curly, and circulating-current-carrying...)*

Motivation for coloring scheme:
The Traffic Signal



Standing waves

Moving waves

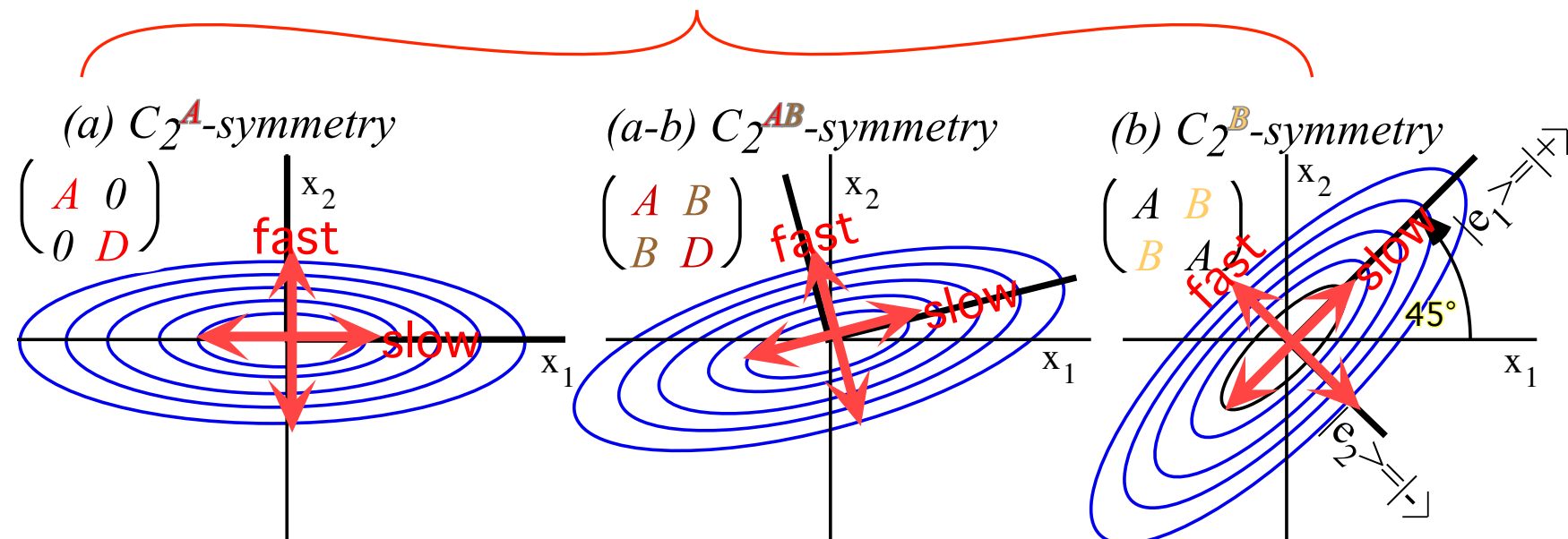

Fig. 10.1.2 Potentials for (a) C_2^A -asymmetric-diagonal, (ab) C_2^{AB} -mixed, (b) C_2^B -bilateral U(2)system.

ABCD Symmetry operator analysis and U(2) spinors

Decompose the Hamiltonian operator \mathbf{H} into four *ABCD symmetry operators*

(Labeled to provide dynamic mnemonics as well as colorful analogies)

$$\begin{aligned} \begin{pmatrix} A & B-iC \\ B+iC & D \end{pmatrix} &= A \begin{pmatrix} 1 & 0 \\ 0 & 0 \end{pmatrix} + B \begin{pmatrix} 0 & 1 \\ 1 & 0 \end{pmatrix} + C \begin{pmatrix} 0 & -i \\ i & 0 \end{pmatrix} + D \begin{pmatrix} 0 & 0 \\ 0 & 1 \end{pmatrix} = A\mathbf{e}_{11} + B\boldsymbol{\sigma}_B + C\boldsymbol{\sigma}_C + D\mathbf{e}_{22} \\ &= \frac{A-D}{2} \begin{pmatrix} 1 & 0 \\ 0 & -1 \end{pmatrix} + B \begin{pmatrix} 0 & 1 \\ 1 & 0 \end{pmatrix} + C \begin{pmatrix} 0 & -i \\ i & 0 \end{pmatrix} + \frac{A+D}{2} \begin{pmatrix} 1 & 0 \\ 0 & 1 \end{pmatrix} \\ \mathbf{H} &= \frac{A-D}{2} \boldsymbol{\sigma}_A + B \boldsymbol{\sigma}_B + C \boldsymbol{\sigma}_C + \frac{A+D}{2} \boldsymbol{\sigma}_0 \end{aligned}$$

Symmetry archetypes: *A (Asymmetric-diagonal)* | *B (Bilateral-balanced)* | *C (Chiral-circular-complex-Coriolis-cyclotron-curly...)*

The $\{\boldsymbol{\sigma}_I, \boldsymbol{\sigma}_A, \boldsymbol{\sigma}_B, \boldsymbol{\sigma}_C\}$ are best known as *Pauli-spin operators* $\{\boldsymbol{\sigma}_I = \boldsymbol{\sigma}_0, \boldsymbol{\sigma}_B = \boldsymbol{\sigma}_X, \boldsymbol{\sigma}_C = \boldsymbol{\sigma}_Y, \boldsymbol{\sigma}_A = \boldsymbol{\sigma}_Z\}$ developed in 1927.

Wolfgang Pauli (1927) Zur Quantenmechanik des magnetischen Elektrons *Zeitschrift für Physik* (43) 601-623

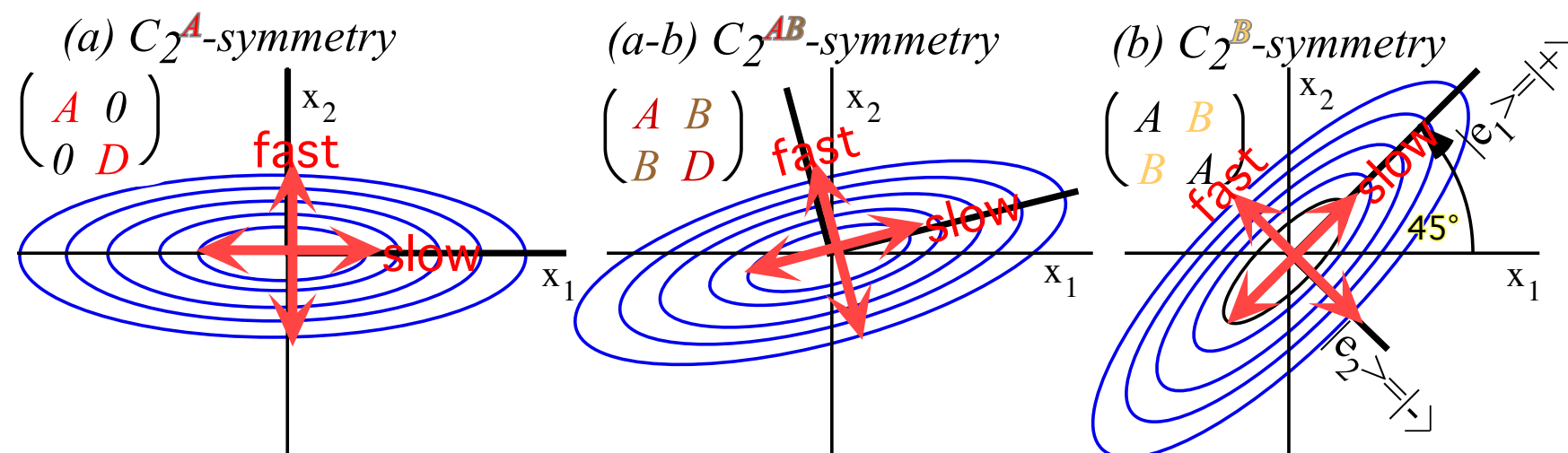

Fig. 10.1.2 Potentials for (a) C_2^A -asymmetric-diagonal, (ab) C_2^{AB} -mixed, (b) C_2^B -bilateral U(2)system.

ABCD Symmetry operator analysis and U(2) spinors

Decompose the Hamiltonian operator \mathbf{H} into four *ABCD symmetry operators*

(Labeled to provide dynamic mnemonics as well as colorful analogies)

$$\begin{aligned} \begin{pmatrix} A & B-iC \\ B+iC & D \end{pmatrix} &= A \begin{pmatrix} 1 & 0 \\ 0 & 0 \end{pmatrix} + B \begin{pmatrix} 0 & 1 \\ 1 & 0 \end{pmatrix} + C \begin{pmatrix} 0 & -i \\ i & 0 \end{pmatrix} + D \begin{pmatrix} 0 & 0 \\ 0 & 1 \end{pmatrix} = A\mathbf{e}_{11} + B\boldsymbol{\sigma}_B + C\boldsymbol{\sigma}_C + D\mathbf{e}_{22} \\ &= \frac{A-D}{2} \begin{pmatrix} 1 & 0 \\ 0 & -1 \end{pmatrix} + B \begin{pmatrix} 0 & 1 \\ 1 & 0 \end{pmatrix} + C \begin{pmatrix} 0 & -i \\ i & 0 \end{pmatrix} + \frac{A+D}{2} \begin{pmatrix} 1 & 0 \\ 0 & 1 \end{pmatrix} \\ \mathbf{H} &= \frac{A-D}{2} \boldsymbol{\sigma}_A + B \boldsymbol{\sigma}_B + C \boldsymbol{\sigma}_C + \frac{A+D}{2} \boldsymbol{\sigma}_0 \end{aligned}$$

Symmetry archetypes: *A (Asymmetric-diagonal)* | *B (Bilateral-balanced)* | *C (Chiral-circular-complex-Coriolis-cyclotron-curly...)*

The $\{\boldsymbol{\sigma}_I, \boldsymbol{\sigma}_A, \boldsymbol{\sigma}_B, \boldsymbol{\sigma}_C\}$ are best known as *Pauli-spin operators* $\{\boldsymbol{\sigma}_I = \boldsymbol{\sigma}_0, \boldsymbol{\sigma}_B = \boldsymbol{\sigma}_X, \boldsymbol{\sigma}_C = \boldsymbol{\sigma}_Y, \boldsymbol{\sigma}_A = \boldsymbol{\sigma}_Z\}$ developed in 1927.

Wolfgang Pauli (1927) Zur Quantenmechanik des magnetischen Elektrons *Zeitschrift für Physik* (43) 601-623

In 1843 Hamilton invents *quaternions* $\{1, \mathbf{i}, \mathbf{j}, \mathbf{k}\}$. $\boldsymbol{\sigma}_\mu$ related by *i*-factor: $\{\boldsymbol{\sigma}_I = 1 = \boldsymbol{\sigma}_0, i\boldsymbol{\sigma}_B = \mathbf{i} = i\boldsymbol{\sigma}_X, i\boldsymbol{\sigma}_C = \mathbf{j} = i\boldsymbol{\sigma}_Y, i\boldsymbol{\sigma}_A = \mathbf{k} = i\boldsymbol{\sigma}_Z\}$.

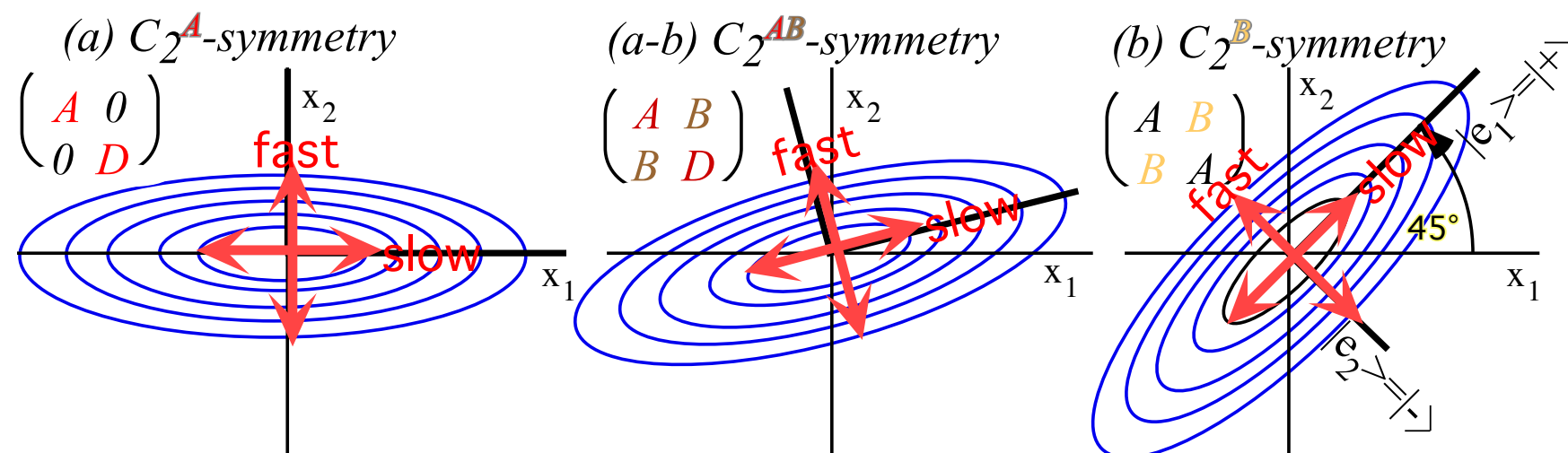

Fig. 10.1.2 Potentials for (a) C_2^A -asymmetric-diagonal, (ab) C_2^{AB} -mixed, (b) C_2^B -bilateral U(2)system.

ABCD Symmetry operator analysis and U(2) spinors

Decompose the Hamiltonian operator \mathbf{H} into four *ABCD symmetry operators*

(Labeled to provide dynamic mnemonics as well as colorful analogies)

$$\begin{aligned} \begin{pmatrix} A & B-iC \\ B+iC & D \end{pmatrix} &= A \begin{pmatrix} 1 & 0 \\ 0 & 0 \end{pmatrix} + B \begin{pmatrix} 0 & 1 \\ 1 & 0 \end{pmatrix} + C \begin{pmatrix} 0 & -i \\ i & 0 \end{pmatrix} + D \begin{pmatrix} 0 & 0 \\ 0 & 1 \end{pmatrix} = A\mathbf{e}_{11} + B\boldsymbol{\sigma}_B + C\boldsymbol{\sigma}_C + D\mathbf{e}_{22} \\ &= \frac{A-D}{2} \begin{pmatrix} 1 & 0 \\ 0 & -1 \end{pmatrix} + B \begin{pmatrix} 0 & 1 \\ 1 & 0 \end{pmatrix} + C \begin{pmatrix} 0 & -i \\ i & 0 \end{pmatrix} + \frac{A+D}{2} \begin{pmatrix} 1 & 0 \\ 0 & 1 \end{pmatrix} \\ \mathbf{H} &= \frac{A-D}{2} \boldsymbol{\sigma}_A + B \boldsymbol{\sigma}_B + C \boldsymbol{\sigma}_C + \frac{A+D}{2} \boldsymbol{\sigma}_0 \end{aligned}$$

Symmetry archetypes: *A (Asymmetric-diagonal)* | *B (Bilateral-balanced)* | *C (Chiral-circular-complex-Coriolis-cyclotron-curly...)*

The $\{\boldsymbol{\sigma}_I, \boldsymbol{\sigma}_A, \boldsymbol{\sigma}_B, \boldsymbol{\sigma}_C\}$ are best known as *Pauli-spin operators* $\{\boldsymbol{\sigma}_I = \boldsymbol{\sigma}_0, \boldsymbol{\sigma}_B = \boldsymbol{\sigma}_X, \boldsymbol{\sigma}_C = \boldsymbol{\sigma}_Y, \boldsymbol{\sigma}_A = \boldsymbol{\sigma}_Z\}$ developed in 1927.

Wolfgang Pauli (1927) Zur Quantenmechanik des magnetischen Elektrons *Zeitschrift für Physik* (43) 601-623

In 1843 Hamilton invents *quaternions* $\{\mathbf{1}, \mathbf{i}, \mathbf{j}, \mathbf{k}\}$. $\boldsymbol{\sigma}_\mu$ related by *i*-factor: $\{\boldsymbol{\sigma}_I = \mathbf{1} = \boldsymbol{\sigma}_0, i\boldsymbol{\sigma}_B = \mathbf{i} = i\boldsymbol{\sigma}_X, i\boldsymbol{\sigma}_C = \mathbf{j} = i\boldsymbol{\sigma}_Y, i\boldsymbol{\sigma}_A = \mathbf{k} = i\boldsymbol{\sigma}_Z\}$.

Each Hamilton quaternion squares to *negative-1* ($\mathbf{i}^2 = \mathbf{j}^2 = \mathbf{k}^2 = -1$) like imaginary number $i^2 = -1$. (They make up the Quaternion group.)

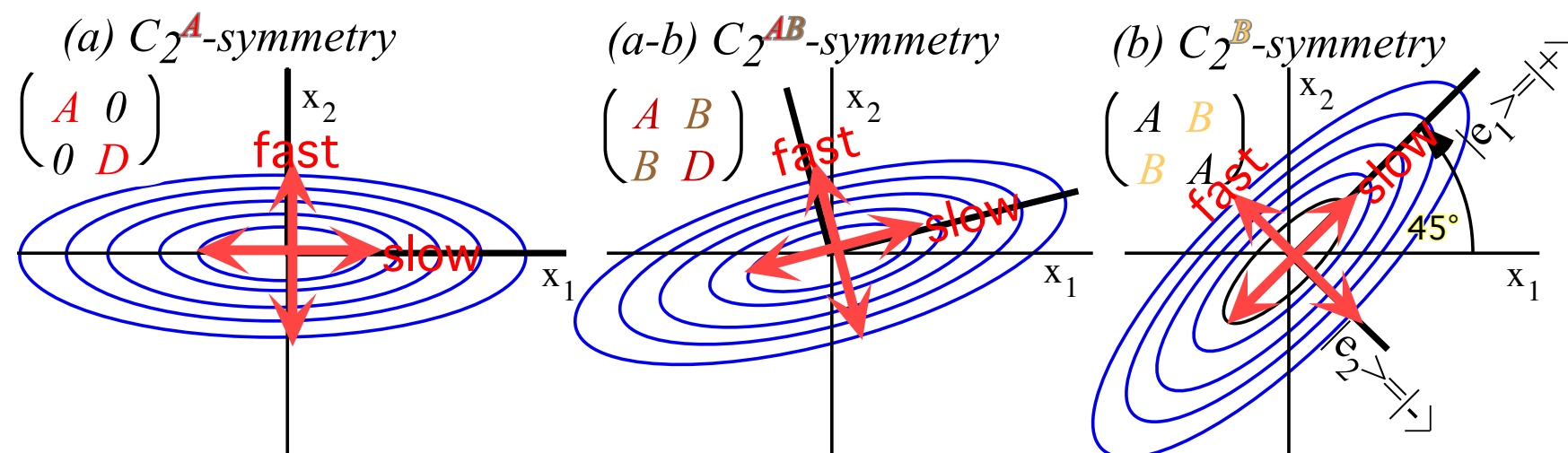

Fig. 10.1.2 Potentials for (a) C_2^A -asymmetric-diagonal, (ab) C_2^{AB} -mixed, (b) C_2^B -bilateral U(2)system.

ABCD Symmetry operator analysis and U(2) spinors

Decompose the Hamiltonian operator \mathbf{H} into four *ABCD symmetry operators*
 (Labeled to provide dynamic mnemonics as well as colorful analogies)

$$\begin{aligned} \begin{pmatrix} A & B-iC \\ B+iC & D \end{pmatrix} &= A \begin{pmatrix} 1 & 0 \\ 0 & 0 \end{pmatrix} + B \begin{pmatrix} 0 & 1 \\ 1 & 0 \end{pmatrix} + C \begin{pmatrix} 0 & -i \\ i & 0 \end{pmatrix} + D \begin{pmatrix} 0 & 0 \\ 0 & 1 \end{pmatrix} = A\mathbf{e}_{11} + B\boldsymbol{\sigma}_B + C\boldsymbol{\sigma}_C + D\mathbf{e}_{22} \\ &= \frac{A-D}{2} \begin{pmatrix} 1 & 0 \\ 0 & -1 \end{pmatrix} + B \begin{pmatrix} 0 & 1 \\ 1 & 0 \end{pmatrix} + C \begin{pmatrix} 0 & -i \\ i & 0 \end{pmatrix} + \frac{A+D}{2} \begin{pmatrix} 1 & 0 \\ 0 & 1 \end{pmatrix} \\ \mathbf{H} &= \frac{A-D}{2} \boldsymbol{\sigma}_A + B \boldsymbol{\sigma}_B + C \boldsymbol{\sigma}_C + \frac{A+D}{2} \boldsymbol{\sigma}_0 \end{aligned}$$

Symmetry archetypes: *A (Asymmetric-diagonal)* | *B (Bilateral-balanced)* | *C (Chiral-circular-complex-Coriolis-cyclotron-curly...)*
 The $\{\boldsymbol{\sigma}_I, \boldsymbol{\sigma}_A, \boldsymbol{\sigma}_B, \boldsymbol{\sigma}_C\}$ are best known as *Pauli-spin operators* $\{\boldsymbol{\sigma}_I = \boldsymbol{\sigma}_0, \boldsymbol{\sigma}_B = \boldsymbol{\sigma}_X, \boldsymbol{\sigma}_C = \boldsymbol{\sigma}_Y, \boldsymbol{\sigma}_A = \boldsymbol{\sigma}_Z\}$ developed in 1927.

Wolfgang Pauli (1927) Zur Quantenmechanik des magnetischen Elektrons *Zeitschrift für Physik* (43) 601-623

In 1843 Hamilton invents *quaternions* $\{\mathbf{1}, \mathbf{i}, \mathbf{j}, \mathbf{k}\}$. $\boldsymbol{\sigma}_\mu$ related by *i*-factor: $\{\boldsymbol{\sigma}_I = \mathbf{1} = \boldsymbol{\sigma}_0, i\boldsymbol{\sigma}_B = \mathbf{i} = i\boldsymbol{\sigma}_X, i\boldsymbol{\sigma}_C = \mathbf{j} = i\boldsymbol{\sigma}_Y, i\boldsymbol{\sigma}_A = \mathbf{k} = i\boldsymbol{\sigma}_Z\}$.

Each Hamilton quaternion squares to *negative-1* ($\mathbf{i}^2 = \mathbf{j}^2 = \mathbf{k}^2 = -1$) like imaginary number $i^2 = -1$. (They make up the Quaternion group.)

Each Pauli $\boldsymbol{\sigma}_\mu$ squares to *positive-1* ($\boldsymbol{\sigma}_X^2 = \boldsymbol{\sigma}_Y^2 = \boldsymbol{\sigma}_Z^2 = +1$) (Each makes a cyclic C_2 group $C_2^A = \{\mathbf{1}, \boldsymbol{\sigma}_A\}$, $C_2^B = \{\mathbf{1}, \boldsymbol{\sigma}_B\}$, or $C_2^C = \{\mathbf{1}, \boldsymbol{\sigma}_C\}$.)

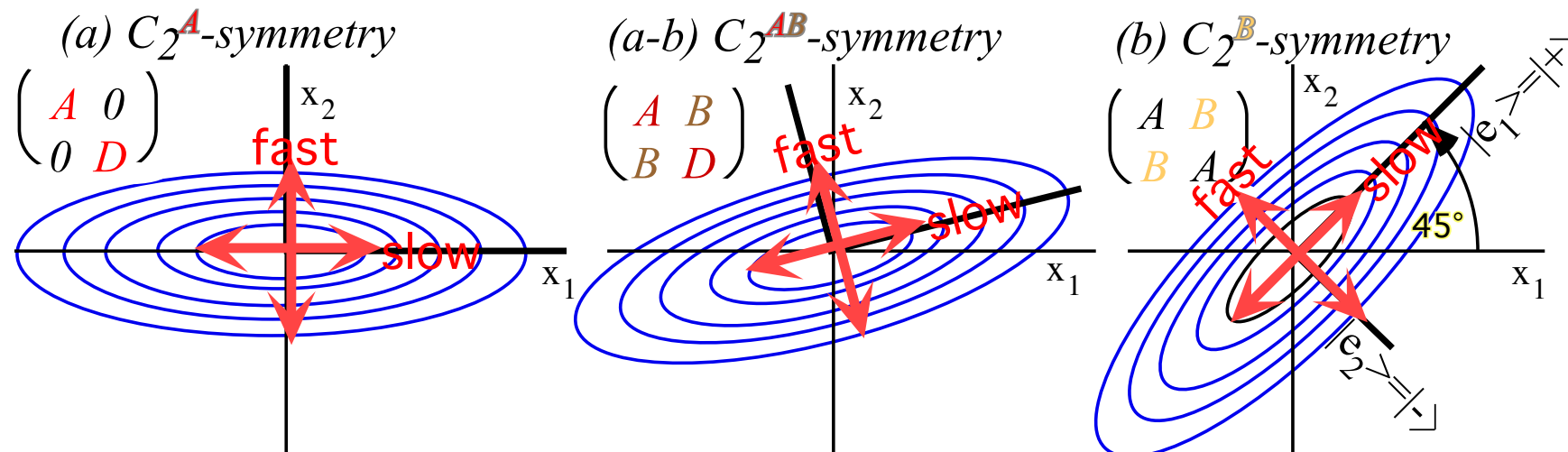
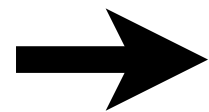

Fig. 10.1.2 Potentials for (a) C_2^A -asymmetric-diagonal, (ab) C_2^{AB} -mixed, (b) C_2^B -bilateral U(2)system.

Review: How C_2 (Bilateral σ_B reflection) symmetry is eigen-solver

$U(2)$ vs $R(3)$: 2-State Schrodinger: $i\hbar\partial_t|\Psi(t)\rangle = \mathbf{H}|\Psi(t)\rangle$ vs. Classical 2D-HO: $\partial_t^2\mathbf{x} = -\mathbf{K}\cdot\mathbf{x}$
Hamilton-Pauli spinor symmetry (σ -expansion in ABCD-Types) $\mathbf{H} = \omega_\mu\sigma_\mu$



Deriving σ -exponential time evolution (or revolution) operator $\mathbf{U} = e^{-i\mathbf{H}t} = e^{-i\sigma_\mu\omega_\mu t}$

→ Spinor arithmetic like complex arithmetic
Spinor vector algebra like complex vector algebra
Spinor exponentials like complex exponentials (“Crazy-Thing”-Theorem)

Geometry of $U(2)$ evolution (or $R(3)$ revolution) operator $\mathbf{U} = e^{-i\mathbf{H}t} = e^{-i\sigma_\mu\omega_\mu t}$

The “mysterious” factors of 2 (or 1/2): 2D Spinor vs 3D Spin Vector space

2D Spinor vs 3D vector rotation

NMR Hamiltonian: 3D Spin Moment \mathbf{m} in \mathbf{B} field

Euler’s state definition using rotations $\mathbf{R}(\alpha, 0, 0)$, $\mathbf{R}(0, \beta, 0)$, and $\mathbf{R}(0, 0, \gamma)$

Spin-1 (3D-real vector) case

Spin-1/2 (2D-complex spinor) case

3D-real Stokes Vector defines 2D-HO polarization ellipses and spinor states

Asymmetry $S_A = S_Z$, Balance $S_B = S_X$, and Chirality $S_C = S_Y$

Polarization ellipse and spinor state dynamics

OBJECTIVE: Evaluate and (*most important!*) *visualize* matrix-exponent solutions.

$$|\Psi(t)\rangle = e^{-i\mathbf{H}\cdot t} |\Psi(0)\rangle$$

Hamilton generalized Euler's expansion $e^{-i\omega t} = \cos \omega t - i \sin \omega t$ so matrix exponential becomes powerful.

*ABCD Time
evolution
operator*

OBJECTIVE: Evaluate and (*most important!*) *visualize* matrix-exponent solutions.

$$|\Psi(t)\rangle = e^{-i\mathbf{H}\cdot t} |\Psi(0)\rangle$$

Hamilton generalized Euler's expansion $e^{-i\omega t} = \cos \omega t - i \sin \omega t$ so matrix exponential becomes powerful.

$$e^{-i\mathbf{H}\cdot t} = e^{-i \begin{pmatrix} A & B-iC \\ B+iC & D \end{pmatrix} \cdot t} = e^{-i \frac{A-D}{2} \begin{pmatrix} 1 & 0 \\ 0 & -1 \end{pmatrix} \cdot t} \cdot e^{-iB \begin{pmatrix} 0 & 1 \\ 1 & 0 \end{pmatrix} \cdot t} \cdot e^{-iC \begin{pmatrix} 0 & -i \\ i & 0 \end{pmatrix} \cdot t} \cdot e^{-i \frac{A+D}{2} \begin{pmatrix} 1 & 0 \\ 0 & 1 \end{pmatrix} \cdot t}$$

$\sigma_A = \sigma_Z$ $\sigma_B = \sigma_X$ $\sigma_C = \sigma_Y$

*ABCD Time
evolution
operator*

OBJECTIVE: Evaluate and (*most important!*) *visualize* matrix-exponent solutions.

$$|\Psi(t)\rangle = e^{-i\mathbf{H}\cdot t} |\Psi(0)\rangle$$

Hamilton generalized Euler's expansion $e^{-i\omega t} = \cos \omega t - i \sin \omega t$ so matrix exponential becomes powerful.

$$e^{-i\mathbf{H}\cdot t} = e^{-i \begin{pmatrix} A & B-iC \\ B+iC & D \end{pmatrix} \cdot t} = e^{-i \frac{A-D}{2} \begin{pmatrix} 1 & 0 \\ 0 & -1 \end{pmatrix} \cdot t} e^{-iB \begin{pmatrix} 0 & 1 \\ 1 & 0 \end{pmatrix} \cdot t} e^{-iC \begin{pmatrix} 0 & -i \\ i & 0 \end{pmatrix} \cdot t} e^{-i \frac{A+D}{2} \begin{pmatrix} 1 & 0 \\ 0 & 1 \end{pmatrix} \cdot t}$$

$\sigma_A = \sigma_Z$ $\sigma_B = \sigma_X$ $\sigma_C = \sigma_Y$

$$= e^{-i\sigma_\varphi \varphi} e^{-i\omega_0 t} = e^{-i\vec{\sigma} \cdot \vec{\omega} \cdot t} e^{-i\omega_0 t} \text{ where: } \vec{\varphi} = \begin{pmatrix} \varphi_A \\ \varphi_B \\ \varphi_C \end{pmatrix} = \vec{\omega} \cdot t = \begin{pmatrix} \omega_A \\ \omega_B \\ \omega_C \end{pmatrix} \cdot t = \begin{pmatrix} \frac{A-D}{2} \\ B \\ C \end{pmatrix} \cdot t \text{ and: } \omega_0 = \frac{A+D}{2}$$

ABCD Time evolution operator

Symmetry relations make spinors $\sigma_X = \sigma_B$, $\sigma_Y = \sigma_C$, and $\sigma_Z = \sigma_A$ or quaternions $\mathbf{i} = -i\sigma_X$, $\mathbf{j} = -i\sigma_Y$, and $\mathbf{k} = -i\sigma_Z$ powerful.

OBJECTIVE: Evaluate and (*most important!*) *visualize* matrix-exponent solutions.

$$|\Psi(t)\rangle = e^{-i\mathbf{H}\cdot t} |\Psi(0)\rangle$$

Hamilton generalized Euler's expansion $e^{-i\omega t} = \cos \omega t - i \sin \omega t$ so matrix exponential becomes powerful.

$$e^{-i\mathbf{H}\cdot t} = e^{-i \begin{pmatrix} A & B-iC \\ B+iC & D \end{pmatrix} \cdot t} = e^{-i \frac{A-D}{2} \begin{pmatrix} 1 & 0 \\ 0 & -1 \end{pmatrix} \cdot t} e^{-iB \begin{pmatrix} 0 & 1 \\ 1 & 0 \end{pmatrix} \cdot t} e^{-iC \begin{pmatrix} 0 & -i \\ i & 0 \end{pmatrix} \cdot t} e^{-i \frac{A+D}{2} \begin{pmatrix} 1 & 0 \\ 0 & 1 \end{pmatrix} \cdot t}$$

$\sigma_A = \sigma_Z$ $\sigma_B = \sigma_X$ $\sigma_C = \sigma_Y$

$$= e^{-i\sigma_\varphi} e^{-i\omega_0 t} = e^{-i\vec{\sigma}\cdot\vec{\omega}\cdot t} e^{-i\omega_0 t} \text{ where: } \vec{\varphi} = \begin{pmatrix} \varphi_A \\ \varphi_B \\ \varphi_C \end{pmatrix} = \vec{\omega} \cdot t = \begin{pmatrix} \omega_A \\ \omega_B \\ \omega_C \end{pmatrix} \cdot t = \begin{pmatrix} \frac{A-D}{2} \\ B \\ C \end{pmatrix} \cdot t \text{ and: } \omega_0 = \frac{A+D}{2}$$

ABCD Time evolution operator

Symmetry relations make spinors $\sigma_X = \sigma_B$, $\sigma_Y = \sigma_C$, and $\sigma_Z = \sigma_A$ or quaternions $\mathbf{i} = -i\sigma_X$, $\mathbf{j} = -i\sigma_Y$, and $\mathbf{k} = -i\sigma_Z$ powerful.

Each σ_x squares to one (unit matrix $\mathbf{1} = \sigma_x \cdot \sigma_x$)

$$(\sigma_X^2 = \sigma_Y^2 = \sigma_Z^2 = +\mathbf{1})$$

OBJECTIVE: Evaluate and (*most important!*) *visualize* matrix-exponent solutions.

$$|\Psi(t)\rangle = e^{-i\mathbf{H}\cdot t} |\Psi(0)\rangle$$

Hamilton generalized Euler's expansion $e^{-i\omega t} = \cos \omega t - i \sin \omega t$ so matrix exponential becomes powerful.

$$e^{-i\mathbf{H}\cdot t} = e^{-i \begin{pmatrix} A & B-iC \\ B+iC & D \end{pmatrix} \cdot t} = e^{-i \frac{A-D}{2} \begin{pmatrix} 1 & 0 \\ 0 & -1 \end{pmatrix} \cdot t} e^{-iB \begin{pmatrix} 0 & 1 \\ 1 & 0 \end{pmatrix} \cdot t} e^{-iC \begin{pmatrix} 0 & -i \\ i & 0 \end{pmatrix} \cdot t} e^{-i \frac{A+D}{2} \begin{pmatrix} 1 & 0 \\ 0 & 1 \end{pmatrix} \cdot t}$$

$\sigma_A = \sigma_Z$ $\sigma_B = \sigma_X$ $\sigma_C = \sigma_Y$

$$= e^{-i\sigma_\varphi} e^{-i\omega_0 t} = e^{-i\vec{\sigma}\cdot\vec{\omega}\cdot t} e^{-i\omega_0 t} \text{ where: } \vec{\varphi} = \begin{pmatrix} \varphi_A \\ \varphi_B \\ \varphi_C \end{pmatrix} = \vec{\omega} \cdot t = \begin{pmatrix} \omega_A \\ \omega_B \\ \omega_C \end{pmatrix} \cdot t = \begin{pmatrix} \frac{A-D}{2} \\ B \\ C \end{pmatrix} \cdot t \text{ and: } \omega_0 = \frac{A+D}{2}$$

ABCD Time evolution operator

Symmetry relations make spinors $\sigma_X = \sigma_B$, $\sigma_Y = \sigma_C$, and $\sigma_Z = \sigma_A$ or quaternions $\mathbf{i} = -i\sigma_X$, $\mathbf{j} = -i\sigma_Y$, and $\mathbf{k} = -i\sigma_Z$ powerful.

Each σ_X squares to one (unit matrix $\mathbf{1} = \sigma_X \cdot \sigma_X$) and each quaternion squares to minus-one ($-\mathbf{1} = \mathbf{i}\cdot\mathbf{i} = \mathbf{j}\cdot\mathbf{j}$, etc.) just like $i = \sqrt{-1}$.

$$(\sigma_X^2 = \sigma_Y^2 = \sigma_Z^2 = +\mathbf{1})$$

OBJECTIVE: Evaluate and (*most important!*) *visualize* matrix-exponent solutions.

$$|\Psi(t)\rangle = e^{-i\mathbf{H}\cdot t} |\Psi(0)\rangle$$

Hamilton generalized Euler's expansion $e^{-i\omega t} = \cos \omega t - i \sin \omega t$ so matrix exponential becomes powerful.

$$e^{-i\mathbf{H}\cdot t} = e^{-i \begin{pmatrix} A & B-iC \\ B+iC & D \end{pmatrix} \cdot t} = e^{-i \frac{A-D}{2} \begin{pmatrix} 1 & 0 \\ 0 & -1 \end{pmatrix} \cdot t} e^{-iB \begin{pmatrix} 0 & 1 \\ 1 & 0 \end{pmatrix} \cdot t} e^{-iC \begin{pmatrix} 0 & -i \\ i & 0 \end{pmatrix} \cdot t} e^{-i \frac{A+D}{2} \begin{pmatrix} 1 & 0 \\ 0 & 1 \end{pmatrix} \cdot t}$$

$\sigma_A = \sigma_Z$ $\sigma_B = \sigma_X$ $\sigma_C = \sigma_Y$

$$= e^{-i\sigma_\varphi \varphi} e^{-i\omega_0 t} = e^{-i\vec{\sigma} \cdot \vec{\omega} \cdot t} e^{-i\omega_0 t} \text{ where: } \vec{\varphi} = \begin{pmatrix} \varphi_A \\ \varphi_B \\ \varphi_C \end{pmatrix} = \vec{\omega} \cdot t = \begin{pmatrix} \omega_A \\ \omega_B \\ \omega_C \end{pmatrix} \cdot t = \begin{pmatrix} \frac{A-D}{2} \\ B \\ C \end{pmatrix} \cdot t \text{ and: } \omega_0 = \frac{A+D}{2}$$

ABCD Time evolution operator

Symmetry relations make spinors $\sigma_X = \sigma_B$, $\sigma_Y = \sigma_C$, and $\sigma_Z = \sigma_A$ or quaternions $\mathbf{i} = -i\sigma_X$, $\mathbf{j} = -i\sigma_Y$, and $\mathbf{k} = -i\sigma_Z$ powerful.

Each σ_x squares to one (unit matrix $\mathbf{1} = \sigma_x \cdot \sigma_x$) and each quaternion squares to minus-one ($-\mathbf{1} = \mathbf{i} \cdot \mathbf{i} = \mathbf{j} \cdot \mathbf{j}$, etc.) just like $i = \sqrt{-1}$.

This is true for spinor components based on *any* unit vector $\hat{\mathbf{a}} = (a_x, a_y, a_z)$ for which $\hat{\mathbf{a}} \cdot \hat{\mathbf{a}} = 1 = a_x^2 + a_y^2 + a_z^2$.

To see this just try it out on any $\hat{\mathbf{a}}$ -component: $\sigma_a = \sigma \cdot \hat{\mathbf{a}} = a_x \sigma_X + a_y \sigma_Y + a_z \sigma_Z$. *Defining spinor/vector operator*

OBJECTIVE: Evaluate and (*most important!*) *visualize* matrix-exponent solutions.

$$|\Psi(t)\rangle = e^{-i\mathbf{H}\cdot t} |\Psi(0)\rangle$$

Hamilton generalized Euler's expansion $e^{-i\omega t} = \cos \omega t - i \sin \omega t$ so matrix exponential becomes powerful.

$$e^{-i\mathbf{H}\cdot t} = e^{-i \begin{pmatrix} A & B-iC \\ B+iC & D \end{pmatrix} \cdot t} = e^{-i \frac{A-D}{2} \begin{pmatrix} 1 & 0 \\ 0 & -1 \end{pmatrix} \cdot t} \cdot e^{-iB \begin{pmatrix} 0 & 1 \\ 1 & 0 \end{pmatrix} \cdot t} \cdot e^{-iC \begin{pmatrix} 0 & -i \\ i & 0 \end{pmatrix} \cdot t} \cdot e^{-i \frac{A+D}{2} \begin{pmatrix} 1 & 0 \\ 0 & 1 \end{pmatrix} \cdot t}$$

$\sigma_A = \sigma_Z$ $\sigma_B = \sigma_X$ $\sigma_C = \sigma_Y$

$$= e^{-i\sigma_\varphi \varphi} e^{-i\omega_0 t} = e^{-i\vec{\sigma} \cdot \vec{\omega} \cdot t} e^{-i\omega_0 t} \text{ where: } \vec{\varphi} = \begin{pmatrix} \varphi_A \\ \varphi_B \\ \varphi_C \end{pmatrix} = \vec{\omega} \cdot t = \begin{pmatrix} \omega_A \\ \omega_B \\ \omega_C \end{pmatrix} \cdot t = \begin{pmatrix} \frac{A-D}{2} \\ B \\ C \end{pmatrix} \cdot t \text{ and: } \omega_0 = \frac{A+D}{2}$$

ABCD Time evolution operator

Symmetry relations make spinors $\sigma_X = \sigma_B$, $\sigma_Y = \sigma_C$, and $\sigma_Z = \sigma_A$ or quaternions $\mathbf{i} = -i\sigma_X$, $\mathbf{j} = -i\sigma_Y$, and $\mathbf{k} = -i\sigma_Z$ powerful.

Each σ_x squares to one (unit matrix $\mathbf{1} = \sigma_x \cdot \sigma_x$) and each quaternion squares to minus-one ($-\mathbf{1} = \mathbf{i} \cdot \mathbf{i} = \mathbf{j} \cdot \mathbf{j}$, etc.) just like $i = \sqrt{-1}$.

This is true for spinor components based on *any* unit vector $\hat{\mathbf{a}} = (a_x, a_y, a_z)$ for which $\hat{\mathbf{a}} \cdot \hat{\mathbf{a}} = 1 = a_x^2 + a_y^2 + a_z^2$.

To see this just try it out on any $\hat{\mathbf{a}}$ -component: $\sigma_a = \sigma \cdot \hat{\mathbf{a}} = a_x \sigma_X + a_y \sigma_Y + a_z \sigma_Z$. *Defining spinor/vector operator*

$$\begin{aligned} \sigma_a^2 &= (\sigma \cdot \hat{\mathbf{a}})(\sigma \cdot \hat{\mathbf{a}}) = (a_x \sigma_X + a_y \sigma_Y + a_z \sigma_Z)(a_x \sigma_X + a_y \sigma_Y + a_z \sigma_Z) \\ &= \begin{matrix} a_x \sigma_X a_x \sigma_X & + a_x \sigma_X a_y \sigma_Y & + a_x \sigma_X a_z \sigma_Z & a_x a_x \sigma_X \sigma_X & + a_x a_y \sigma_X \sigma_Y & + a_x a_z \sigma_X \sigma_Z \\ + a_y \sigma_Y a_x \sigma_X & + a_y \sigma_Y a_y \sigma_Y & + a_y \sigma_Y a_z \sigma_Z & + a_y a_x \sigma_Y \sigma_X & + a_y a_y \sigma_Y \sigma_Y & + a_y a_z \sigma_Y \sigma_Z \\ + a_z \sigma_Z a_x \sigma_X & + a_z \sigma_Z a_y \sigma_Y & + a_z \sigma_Z a_z \sigma_Z & + a_z a_x \sigma_Z \sigma_X & + a_z a_y \sigma_Z \sigma_Y & + a_z a_z \sigma_Z \sigma_Z \end{matrix} \end{aligned}$$

OBJECTIVE: Evaluate and (*most important!*) *visualize* matrix-exponent solutions.

$$|\Psi(t)\rangle = e^{-i\mathbf{H}\cdot t} |\Psi(0)\rangle$$

Hamilton generalized Euler's expansion $e^{-i\omega t} = \cos \omega t - i \sin \omega t$ so matrix exponential becomes powerful.

$$e^{-i\mathbf{H}\cdot t} = e^{-i \begin{pmatrix} A & B-iC \\ B+iC & D \end{pmatrix} \cdot t} = e^{-i \frac{A-D}{2} \begin{pmatrix} 1 & 0 \\ 0 & -1 \end{pmatrix} \cdot t} e^{-iB \begin{pmatrix} 0 & 1 \\ 1 & 0 \end{pmatrix} \cdot t} e^{-iC \begin{pmatrix} 0 & -i \\ i & 0 \end{pmatrix} \cdot t} e^{-i \frac{A+D}{2} \begin{pmatrix} 1 & 0 \\ 0 & 1 \end{pmatrix} \cdot t}$$

$\sigma_A = \sigma_Z$ $\sigma_B = \sigma_X$ $\sigma_C = \sigma_Y$

$$= e^{-i\sigma_{\varphi}} e^{-i\omega_0 t} = e^{-i\vec{\sigma} \cdot \vec{\omega} \cdot t} e^{-i\omega_0 t} \text{ where: } \vec{\varphi} = \begin{pmatrix} \varphi_A \\ \varphi_B \\ \varphi_C \end{pmatrix} = \vec{\omega} \cdot t = \begin{pmatrix} \omega_A \\ \omega_B \\ \omega_C \end{pmatrix} \cdot t = \begin{pmatrix} \frac{A-D}{2} \\ B \\ C \end{pmatrix} \cdot t \text{ and: } \omega_0 = \frac{A+D}{2}$$

ABCD Time evolution operator

Symmetry relations make spinors $\sigma_X = \sigma_B$, $\sigma_Y = \sigma_C$, and $\sigma_Z = \sigma_A$ or quaternions $\mathbf{i} = -i\sigma_X$, $\mathbf{j} = -i\sigma_Y$, and $\mathbf{k} = -i\sigma_Z$ powerful.

Each σ_x squares to one (unit matrix $\mathbf{1} = \sigma_x \cdot \sigma_x$) and each quaternion squares to minus-one ($-\mathbf{1} = \mathbf{i} \cdot \mathbf{i} = \mathbf{j} \cdot \mathbf{j}$, etc.) just like $i = \sqrt{-1}$.

This is true for spinor components based on *any* unit vector $\hat{\mathbf{a}} = (a_x, a_y, a_z)$ for which $\hat{\mathbf{a}} \cdot \hat{\mathbf{a}} = 1 = a_x^2 + a_y^2 + a_z^2$.

To see this just try it out on any $\hat{\mathbf{a}}$ -component: $\sigma_a = \sigma \cdot \hat{\mathbf{a}} = a_x \sigma_X + a_y \sigma_Y + a_z \sigma_Z$.

$$\begin{aligned} \sigma_a^2 &= (\sigma \cdot \hat{\mathbf{a}})(\sigma \cdot \hat{\mathbf{a}}) = (a_x \sigma_X + a_y \sigma_Y + a_z \sigma_Z)(a_x \sigma_X + a_y \sigma_Y + a_z \sigma_Z) \\ &= a_x^2 \sigma_X \sigma_X + a_x a_y \sigma_X \sigma_Y + a_x a_z \sigma_X \sigma_Z + a_y a_x \sigma_Y \sigma_X + a_y^2 \sigma_Y \sigma_Y + a_y a_z \sigma_Y \sigma_Z \\ &\quad + a_z a_x \sigma_Z \sigma_X + a_z a_y \sigma_Z \sigma_Y + a_z^2 \sigma_Z \sigma_Z \end{aligned}$$

$$\begin{aligned} &\begin{pmatrix} \sigma_Z & \cdot & \sigma_X \\ \begin{pmatrix} 1 & 0 \\ 0 & -1 \end{pmatrix} \begin{pmatrix} 0 & 1 \\ 1 & 0 \end{pmatrix} = \begin{pmatrix} 0 & 1 \\ -1 & 0 \end{pmatrix} = i \begin{pmatrix} 0 & -i \\ i & 0 \end{pmatrix} = i\sigma_Y \\ \sigma_X & \cdot \sigma_Z \\ \begin{pmatrix} 0 & 1 \\ 1 & 0 \end{pmatrix} \begin{pmatrix} 1 & 0 \\ 0 & -1 \end{pmatrix} = \begin{pmatrix} 0 & -1 \\ 1 & 0 \end{pmatrix} = -i \begin{pmatrix} 0 & -i \\ i & 0 \end{pmatrix} = -i\sigma_Y \end{pmatrix} \end{aligned}$$

To finish we need another symmetry property called *anti-commutation*: $\sigma_x \sigma_y = -\sigma_y \sigma_x$, $\sigma_x \sigma_z = -\sigma_z \sigma_x$, etc.

$$\begin{aligned} \sigma_a^2 &= (\sigma \cdot \hat{\mathbf{a}})(\sigma \cdot \hat{\mathbf{a}}) = (a_x \sigma_X + a_y \sigma_Y + a_z \sigma_Z)(a_x \sigma_X + a_y \sigma_Y + a_z \sigma_Z) \\ &= a_x^2 \mathbf{1} + a_x a_y \sigma_X \sigma_Y + a_x a_z \sigma_X \sigma_Z \\ &\quad - a_x a_y \sigma_X \sigma_Y + a_y^2 \mathbf{1} + a_y a_z \sigma_Y \sigma_Z \\ &\quad - a_x a_z \sigma_X \sigma_Z - a_y a_z \sigma_Y \sigma_Z + a_z^2 \mathbf{1} \end{aligned}$$

$$= (a_x^2 + a_y^2 + a_z^2) \mathbf{1} = \mathbf{1}$$

So: $\sigma_a^2 = \mathbf{1}$

Review: How C_2 (Bilateral σ_B reflection) symmetry is eigen-solver

$U(2)$ vs $R(3)$: 2-State Schrodinger: $i\hbar\partial_t|\Psi(t)\rangle = \mathbf{H}|\Psi(t)\rangle$ vs. Classical 2D-HO: $\partial_t^2\mathbf{x} = -\mathbf{K}\cdot\mathbf{x}$
Hamilton-Pauli spinor symmetry (σ -expansion in $ABCD$ -Types) $\mathbf{H} = \omega_\mu\sigma_\mu$

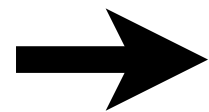

Deriving σ -exponential time evolution (or revolution) operator $\mathbf{U} = e^{-i\mathbf{H}t} = e^{-i\sigma_\mu\omega_\mu t}$

Spinor arithmetic like complex arithmetic

→ Spinor vector algebra like complex vector algebra

Spinor exponentials like complex exponentials ("Crazy-Thing"-Theorem)

Geometry of $U(2)$ evolution (or $R(3)$ revolution) operator $\mathbf{U} = e^{-i\mathbf{H}t} = e^{-i\sigma_\mu\omega_\mu t}$

The "mysterious" factors of 2 (or 1/2): 2D Spinor vs 3D Spin Vector space

2D Spinor vs 3D vector rotation

NMR Hamiltonian: 3D Spin Moment \mathbf{m} in \mathbf{B} field

Euler's state definition using rotations $\mathbf{R}(\alpha, 0, 0)$, $\mathbf{R}(0, \beta, 0)$, and $\mathbf{R}(0, 0, \gamma)$

Spin-1 (3D-real vector) case

Spin-1/2 (2D-complex spinor) case

3D-real Stokes Vector defines 2D-HO polarization ellipses and spinor states

Asymmetry $S_A = S_Z$, Balance $S_B = S_X$, and Chirality $S_C = S_Y$

Polarization ellipse and spinor state dynamics

OBJECTIVE: Evaluate and (*most important!*) *visualize* matrix-exponent solutions.

$$|\Psi(t)\rangle = e^{-i\mathbf{H}\cdot t} |\Psi(0)\rangle$$

Hamilton generalized Euler's expansion $e^{-i\omega t} = \cos \omega t - i \sin \omega t$ so matrix exponential becomes powerful.

$$e^{-i\mathbf{H}\cdot t} = e^{-i \begin{pmatrix} A & B-iC \\ B+iC & D \end{pmatrix} \cdot t} = e^{-i \frac{A-D}{2} \begin{pmatrix} 1 & 0 \\ 0 & -1 \end{pmatrix} \cdot t} e^{-iB \begin{pmatrix} 0 & 1 \\ 1 & 0 \end{pmatrix} \cdot t} e^{-iC \begin{pmatrix} 0 & -i \\ i & 0 \end{pmatrix} \cdot t} e^{-i \frac{A+D}{2} \begin{pmatrix} 1 & 0 \\ 0 & 1 \end{pmatrix} \cdot t}$$

$\sigma_A = \sigma_Z$ $\sigma_B = \sigma_X$ $\sigma_C = \sigma_Y$

$$= e^{-i\sigma_\varphi \varphi} e^{-i\omega_0 t} = e^{-i\vec{\sigma} \cdot \vec{\omega} \cdot t} e^{-i\omega_0 t} \text{ where: } \vec{\varphi} = \begin{pmatrix} \varphi_A \\ \varphi_B \\ \varphi_C \end{pmatrix} = \vec{\omega} \cdot t = \begin{pmatrix} \omega_A \\ \omega_B \\ \omega_C \end{pmatrix} \cdot t = \begin{pmatrix} \frac{A-D}{2} \\ B \\ C \end{pmatrix} \cdot t \text{ and: } \omega_0 = \frac{A+D}{2}$$

ABCD Time evolution operator

Symmetry relations make spinors $\sigma_X = \sigma_B$, $\sigma_Y = \sigma_C$, and $\sigma_Z = \sigma_A$ or quaternions $\mathbf{i} = -i\sigma_X$, $\mathbf{j} = -i\sigma_Y$, and $\mathbf{k} = -i\sigma_Z$ powerful.

σ -products do dot \cdot and cross \times products by symmetries: $\sigma_X \sigma_Y = i\sigma_Z = -\sigma_Y \sigma_X$, $\sigma_Z \sigma_X = i\sigma_Y = -\sigma_X \sigma_Z$, $\sigma_Y \sigma_Z = i\sigma_X = -\sigma_Z \sigma_Y$

OBJECTIVE: Evaluate and (*most important!*) *visualize* matrix-exponent solutions.

$$|\Psi(t)\rangle = e^{-i\mathbf{H}\cdot t} |\Psi(0)\rangle$$

Hamilton generalized Euler's expansion $e^{-i\omega t} = \cos \omega t - i \sin \omega t$ so matrix exponential becomes powerful.

$$e^{-i\mathbf{H}\cdot t} = e^{-i \begin{pmatrix} A & B-iC \\ B+iC & D \end{pmatrix} \cdot t} = e^{-i \frac{A-D}{2} \begin{pmatrix} 1 & 0 \\ 0 & -1 \end{pmatrix} \cdot t} e^{-iB \begin{pmatrix} 0 & 1 \\ 1 & 0 \end{pmatrix} \cdot t} e^{-iC \begin{pmatrix} 0 & -i \\ i & 0 \end{pmatrix} \cdot t} e^{-i \frac{A+D}{2} \begin{pmatrix} 1 & 0 \\ 0 & 1 \end{pmatrix} \cdot t}$$

$\sigma_A = \sigma_Z$ $\sigma_B = \sigma_X$ $\sigma_C = \sigma_Y$

$$= e^{-i\sigma_\varphi \varphi} e^{-i\omega_0 t} = e^{-i\vec{\sigma} \cdot \vec{\omega} \cdot t} e^{-i\omega_0 t} \text{ where: } \vec{\varphi} = \begin{pmatrix} \varphi_A \\ \varphi_B \\ \varphi_C \end{pmatrix} = \vec{\omega} \cdot t = \begin{pmatrix} \omega_A \\ \omega_B \\ \omega_C \end{pmatrix} \cdot t = \begin{pmatrix} \frac{A-D}{2} \\ B \\ C \end{pmatrix} \cdot t \text{ and: } \omega_0 = \frac{A+D}{2}$$

ABCD Time evolution operator

Symmetry relations make spinors $\sigma_X = \sigma_B$, $\sigma_Y = \sigma_C$, and $\sigma_Z = \sigma_A$ or quaternions $\mathbf{i} = -i\sigma_X$, $\mathbf{j} = -i\sigma_Y$, and $\mathbf{k} = -i\sigma_Z$ powerful.

σ -products do dot \cdot and cross \times products by symmetries: $\sigma_X \sigma_Y = i\sigma_Z = -\sigma_Y \sigma_X$, $\sigma_Z \sigma_X = i\sigma_Y = -\sigma_X \sigma_Z$, $\sigma_Y \sigma_Z = i\sigma_X = -\sigma_Z \sigma_Y$

$$\sigma_a \sigma_b = (\sigma \cdot \mathbf{a})(\sigma \cdot \mathbf{b}) = (a_X \sigma_X + a_Y \sigma_Y + a_Z \sigma_Z)(b_X \sigma_X + b_Y \sigma_Y + b_Z \sigma_Z)$$

OBJECTIVE: Evaluate and (*most important!*) *visualize* matrix-exponent solutions.

$$|\Psi(t)\rangle = e^{-i\mathbf{H}\cdot t} |\Psi(0)\rangle$$

Hamilton generalized Euler's expansion $e^{-i\omega t} = \cos \omega t - i \sin \omega t$ so matrix exponential becomes powerful.

$$e^{-i\mathbf{H}\cdot t} = e^{-i \begin{pmatrix} A & B-iC \\ B+iC & D \end{pmatrix} \cdot t} = e^{-i \frac{A-D}{2} \begin{pmatrix} 1 & 0 \\ 0 & -1 \end{pmatrix} \cdot t} e^{-iB \begin{pmatrix} 0 & 1 \\ 1 & 0 \end{pmatrix} \cdot t} e^{-iC \begin{pmatrix} 0 & -i \\ i & 0 \end{pmatrix} \cdot t} e^{-i \frac{A+D}{2} \begin{pmatrix} 1 & 0 \\ 0 & 1 \end{pmatrix} \cdot t}$$

$\sigma_A = \sigma_Z$ $\sigma_B = \sigma_X$ $\sigma_C = \sigma_Y$

$$= e^{-i\sigma_\varphi \varphi} e^{-i\omega_0 t} = e^{-i\vec{\sigma} \cdot \vec{\omega} \cdot t} e^{-i\omega_0 t} \text{ where: } \vec{\varphi} = \begin{pmatrix} \varphi_A \\ \varphi_B \\ \varphi_C \end{pmatrix} = \vec{\omega} \cdot t = \begin{pmatrix} \omega_A \\ \omega_B \\ \omega_C \end{pmatrix} \cdot t = \begin{pmatrix} \frac{A-D}{2} \\ B \\ C \end{pmatrix} \cdot t \text{ and: } \omega_0 = \frac{A+D}{2}$$

ABCD Time evolution operator

Symmetry relations make spinors $\sigma_X = \sigma_B$, $\sigma_Y = \sigma_C$, and $\sigma_Z = \sigma_A$ or quaternions $\mathbf{i} = -i\sigma_X$, $\mathbf{j} = -i\sigma_Y$, and $\mathbf{k} = -i\sigma_Z$ powerful.

σ -products do dot \cdot and cross \times products by symmetries: $\sigma_X \sigma_Y = i\sigma_Z = -\sigma_Y \sigma_X$, $\sigma_Z \sigma_X = i\sigma_Y = -\sigma_X \sigma_Z$, $\sigma_Y \sigma_Z = i\sigma_X = -\sigma_Z \sigma_Y$

$$\sigma_a \sigma_b = (\sigma \cdot \mathbf{a})(\sigma \cdot \mathbf{b}) = (a_X \sigma_X + a_Y \sigma_Y + a_Z \sigma_Z)(b_X \sigma_X + b_Y \sigma_Y + b_Z \sigma_Z)$$

$$= \begin{matrix} a_X b_X \mathbf{1} & + a_X b_Y \sigma_X \sigma_Y & - a_X b_Z \sigma_Z \sigma_X \\ - a_Y b_X \sigma_X \sigma_Y & + a_Y b_Y \mathbf{1} & + a_Y b_Z \sigma_Y \sigma_Z \\ + a_Z b_X \sigma_Z \sigma_X & - a_Z b_Y \sigma_Y \sigma_Z & + a_Z b_Z \mathbf{1} \end{matrix}$$

$$\begin{matrix} \sigma_Z \cdot \sigma_X \\ \begin{pmatrix} 1 & 0 \\ 0 & -1 \end{pmatrix} \begin{pmatrix} 0 & 1 \\ 1 & 0 \end{pmatrix} = \begin{pmatrix} 0 & 1 \\ -1 & 0 \end{pmatrix} = i \begin{pmatrix} 0 & -i \\ i & 0 \end{pmatrix} = i\sigma_Y \\ \sigma_X \cdot \sigma_Z \\ \begin{pmatrix} 0 & 1 \\ 1 & 0 \end{pmatrix} \begin{pmatrix} 1 & 0 \\ 0 & -1 \end{pmatrix} = \begin{pmatrix} 0 & -1 \\ 1 & 0 \end{pmatrix} = -i \begin{pmatrix} 0 & -i \\ i & 0 \end{pmatrix} = -i\sigma_Y \end{matrix}$$

OBJECTIVE: Evaluate and (*most important!*) *visualize* matrix-exponent solutions.

$$|\Psi(t)\rangle = e^{-i\mathbf{H}\cdot t} |\Psi(0)\rangle$$

Hamilton generalized Euler's expansion $e^{-i\omega t} = \cos \omega t - i \sin \omega t$ so matrix exponential becomes powerful.

$$e^{-i\mathbf{H}\cdot t} = e^{-i \begin{pmatrix} A & B-iC \\ B+iC & D \end{pmatrix} \cdot t} = e^{-i \frac{A-D}{2} \begin{pmatrix} 1 & 0 \\ 0 & -1 \end{pmatrix} \cdot t} e^{-iB \begin{pmatrix} 0 & 1 \\ 1 & 0 \end{pmatrix} \cdot t} e^{-iC \begin{pmatrix} 0 & -i \\ i & 0 \end{pmatrix} \cdot t} e^{-i \frac{A+D}{2} \begin{pmatrix} 1 & 0 \\ 0 & 1 \end{pmatrix} \cdot t}$$

$\sigma_A = \sigma_Z$ $\sigma_B = \sigma_X$ $\sigma_C = \sigma_Y$

$$= e^{-i\sigma_{\varphi}} e^{-i\omega_0 t} = e^{-i\vec{\sigma} \cdot \vec{\omega} \cdot t} e^{-i\omega_0 t} \text{ where: } \vec{\varphi} = \begin{pmatrix} \varphi_A \\ \varphi_B \\ \varphi_C \end{pmatrix} = \vec{\omega} \cdot t = \begin{pmatrix} \omega_A \\ \omega_B \\ \omega_C \end{pmatrix} \cdot t = \begin{pmatrix} \frac{A-D}{2} \\ B \\ C \end{pmatrix} \cdot t \text{ and: } \omega_0 = \frac{A+D}{2}$$

ABCD Time evolution operator

Symmetry relations make spinors $\sigma_X = \sigma_B$, $\sigma_Y = \sigma_C$, and $\sigma_Z = \sigma_A$ or quaternions $\mathbf{i} = -i\sigma_X$, $\mathbf{j} = -i\sigma_Y$, and $\mathbf{k} = -i\sigma_Z$ powerful.

σ -products do dot \cdot and cross \times products by symmetries: $\sigma_X \sigma_Y = i\sigma_Z = -\sigma_Y \sigma_X$, $\sigma_Z \sigma_X = i\sigma_Y = -\sigma_X \sigma_Z$, $\sigma_Y \sigma_Z = i\sigma_X = -\sigma_Z \sigma_Y$

$$\sigma_a \sigma_b = (\sigma \cdot \mathbf{a})(\sigma \cdot \mathbf{b}) = (a_X \sigma_X + a_Y \sigma_Y + a_Z \sigma_Z)(b_X \sigma_X + b_Y \sigma_Y + b_Z \sigma_Z)$$

$$= \begin{matrix} a_X b_X \mathbf{1} & + a_X b_Y \sigma_X \sigma_Y & - a_X b_Z \sigma_Z \sigma_X & + i(a_Y b_Z - a_Z b_Y) \sigma_X \\ - a_Y b_X \sigma_X \sigma_Y & + a_Y b_Y \mathbf{1} & + a_Y b_Z \sigma_Y \sigma_Z & + i(a_Z b_X - a_X b_Z) \sigma_Y \\ + a_Z b_X \sigma_Z \sigma_X & - a_Z b_Y \sigma_Y \sigma_Z & + a_Z b_Z \mathbf{1} & + i(a_X b_Y - a_Y b_X) \sigma_Z \end{matrix}$$

$$\begin{matrix} \sigma_Z \cdot \sigma_X \\ \begin{pmatrix} 1 & 0 \\ 0 & -1 \end{pmatrix} \begin{pmatrix} 0 & 1 \\ 1 & 0 \end{pmatrix} = \begin{pmatrix} 0 & 1 \\ -1 & 0 \end{pmatrix} = i \begin{pmatrix} 0 & -i \\ i & 0 \end{pmatrix} = i\sigma_Y \\ \sigma_X \cdot \sigma_Z \\ \begin{pmatrix} 0 & 1 \\ 1 & 0 \end{pmatrix} \begin{pmatrix} 1 & 0 \\ 0 & -1 \end{pmatrix} = \begin{pmatrix} 0 & -1 \\ 1 & 0 \end{pmatrix} = -i \begin{pmatrix} 0 & -i \\ i & 0 \end{pmatrix} = -i\sigma_Y \end{matrix}$$

OBJECTIVE: Evaluate and (*most important!*) *visualize* matrix-exponent solutions.

$$|\Psi(t)\rangle = e^{-i\mathbf{H}\cdot t} |\Psi(0)\rangle$$

Hamilton generalized Euler's expansion $e^{-i\omega t} = \cos \omega t - i \sin \omega t$ so matrix exponential becomes powerful.

$$e^{-i\mathbf{H}\cdot t} = e^{-i \begin{pmatrix} A & B-iC \\ B+iC & D \end{pmatrix} \cdot t} = e^{-i \frac{A-D}{2} \begin{pmatrix} 1 & 0 \\ 0 & -1 \end{pmatrix} \cdot t} \cdot e^{-iB \begin{pmatrix} 0 & 1 \\ 1 & 0 \end{pmatrix} \cdot t} \cdot e^{-iC \begin{pmatrix} 0 & -i \\ i & 0 \end{pmatrix} \cdot t} \cdot e^{-i \frac{A+D}{2} \begin{pmatrix} 1 & 0 \\ 0 & 1 \end{pmatrix} \cdot t}$$

$\sigma_A = \sigma_Z$ $\sigma_B = \sigma_X$ $\sigma_C = \sigma_Y$

$$= e^{-i\sigma_\varphi \varphi} e^{-i\omega_0 t} = e^{-i\vec{\sigma} \cdot \vec{\omega} t} e^{-i\omega_0 t} \text{ where: } \vec{\varphi} = \begin{pmatrix} \varphi_A \\ \varphi_B \\ \varphi_C \end{pmatrix} = \vec{\omega} \cdot t = \begin{pmatrix} \omega_A \\ \omega_B \\ \omega_C \end{pmatrix} \cdot t = \begin{pmatrix} \frac{A-D}{2} \\ B \\ C \end{pmatrix} \cdot t \text{ and: } \omega_0 = \frac{A+D}{2}$$

ABCD Time evolution operator

Symmetry relations make spinors $\sigma_X = \sigma_B$, $\sigma_Y = \sigma_C$, and $\sigma_Z = \sigma_A$ or quaternions $\mathbf{i} = -i\sigma_X$, $\mathbf{j} = -i\sigma_Y$, and $\mathbf{k} = -i\sigma_Z$ powerful.

σ -products do dot \cdot and cross \times products by symmetries: $\sigma_X \sigma_Y = i\sigma_Z = -\sigma_Y \sigma_X$, $\sigma_Z \sigma_X = i\sigma_Y = -\sigma_X \sigma_Z$, $\sigma_Y \sigma_Z = i\sigma_X = -\sigma_Z \sigma_Y$

$$\begin{aligned} \sigma_a \sigma_b &= (\sigma \cdot \mathbf{a})(\sigma \cdot \mathbf{b}) = (a_X \sigma_X + a_Y \sigma_Y + a_Z \sigma_Z)(b_X \sigma_X + b_Y \sigma_Y + b_Z \sigma_Z) \\ &= \begin{matrix} a_X b_X \mathbf{1} & +a_X b_Y \sigma_X \sigma_Y & -a_X b_Z \sigma_Z \sigma_X & +i(a_Y b_Z - a_Z b_Y) \sigma_X \\ -a_Y b_X \sigma_X \sigma_Y & +a_Y b_Y \mathbf{1} & +a_Y b_Z \sigma_Y \sigma_Z & +i(a_Z b_X - a_X b_Z) \sigma_Y \\ +a_Z b_X \sigma_Z \sigma_X & -a_Z b_Y \sigma_Y \sigma_Z & +a_Z b_Z \mathbf{1} & +i(a_X b_Y - a_Y b_X) \sigma_Z \end{matrix} \\ &= (a_X b_X + a_Y b_Y + a_Z b_Z) \mathbf{1} + i(a_Y b_Z - a_Z b_Y) \sigma_X + i(a_Z b_X - a_X b_Z) \sigma_Y + i(a_X b_Y - a_Y b_X) \sigma_Z \end{aligned}$$

Write the product in Gibbs notation. (This is where Gibbs got his $\{\mathbf{i}, \mathbf{j}, \mathbf{k}\}$ notation!)

$$\sigma_a \sigma_b = (\sigma \cdot \mathbf{a})(\sigma \cdot \mathbf{b}) = (\mathbf{a} \cdot \mathbf{b}) \mathbf{1} + i(\mathbf{a} \times \mathbf{b}) \cdot \sigma$$

$$\begin{aligned} \sigma_Z \cdot \sigma_X &= \begin{pmatrix} 1 & 0 \\ 0 & -1 \end{pmatrix} \begin{pmatrix} 0 & 1 \\ 1 & 0 \end{pmatrix} = \begin{pmatrix} 0 & 1 \\ -1 & 0 \end{pmatrix} = i \begin{pmatrix} 0 & -i \\ i & 0 \end{pmatrix} = i\sigma_Y \\ \sigma_X \cdot \sigma_Z &= \begin{pmatrix} 0 & 1 \\ 1 & 0 \end{pmatrix} \begin{pmatrix} 1 & 0 \\ 0 & -1 \end{pmatrix} = \begin{pmatrix} 0 & -1 \\ 1 & 0 \end{pmatrix} = -i \begin{pmatrix} 0 & -i \\ i & 0 \end{pmatrix} = -i\sigma_Y \end{aligned}$$

OBJECTIVE: Evaluate and (*most important!*) *visualize* matrix-exponent solutions.

$$|\Psi(t)\rangle = e^{-i\mathbf{H}\cdot t} |\Psi(0)\rangle$$

Hamilton generalized Euler's expansion $e^{-i\omega t} = \cos \omega t - i \sin \omega t$ so matrix exponential becomes powerful.

$$e^{-i\mathbf{H}\cdot t} = e^{-i \begin{pmatrix} A & B-iC \\ B+iC & D \end{pmatrix} \cdot t} = e^{-i \frac{A-D}{2} \begin{pmatrix} 1 & 0 \\ 0 & -1 \end{pmatrix} \cdot t} e^{-iB \begin{pmatrix} 0 & 1 \\ 1 & 0 \end{pmatrix} \cdot t} e^{-iC \begin{pmatrix} 0 & -i \\ i & 0 \end{pmatrix} \cdot t} e^{-i \frac{A+D}{2} \begin{pmatrix} 1 & 0 \\ 0 & 1 \end{pmatrix} \cdot t}$$

$\sigma_A = \sigma_Z$ $\sigma_B = \sigma_X$ $\sigma_C = \sigma_Y$

$$= e^{-i\sigma_\varphi \varphi} e^{-i\omega_0 t} = e^{-i\vec{\sigma} \cdot \vec{\omega} t} e^{-i\omega_0 t} \text{ where: } \vec{\varphi} = \begin{pmatrix} \varphi_A \\ \varphi_B \\ \varphi_C \end{pmatrix} = \vec{\omega} \cdot t = \begin{pmatrix} \omega_A \\ \omega_B \\ \omega_C \end{pmatrix} \cdot t = \begin{pmatrix} \frac{A-D}{2} \\ B \\ C \end{pmatrix} \cdot t \text{ and: } \omega_0 = \frac{A+D}{2}$$

ABCD Time evolution operator

Symmetry relations make spinors $\sigma_X = \sigma_B$, $\sigma_Y = \sigma_C$, and $\sigma_Z = \sigma_A$ or quaternions $\mathbf{i} = -i\sigma_X$, $\mathbf{j} = -i\sigma_Y$, and $\mathbf{k} = -i\sigma_Z$ powerful.

σ -products do dot \bullet and cross \times products by symmetries: $\sigma_X \sigma_Y = i\sigma_Z = -\sigma_Y \sigma_X$, $\sigma_Z \sigma_X = i\sigma_Y = -\sigma_X \sigma_Z$, $\sigma_Y \sigma_Z = i\sigma_X = -\sigma_Z \sigma_Y$

$$\begin{aligned} \sigma_a \sigma_b &= (\sigma \bullet \mathbf{a})(\sigma \bullet \mathbf{b}) = (a_X \sigma_X + a_Y \sigma_Y + a_Z \sigma_Z)(b_X \sigma_X + b_Y \sigma_Y + b_Z \sigma_Z) \\ &= a_X b_X \mathbf{1} + a_X b_Y \sigma_X \sigma_Y - a_X b_Z \sigma_Z \sigma_X + i(a_Y b_Z - a_Z b_Y) \sigma_X \\ &\quad - a_Y b_X \sigma_X \sigma_Y + a_Y b_Y \mathbf{1} + a_Y b_Z \sigma_Y \sigma_Z + i(a_Z b_X - a_X b_Z) \sigma_Y \\ &\quad + a_Z b_X \sigma_Z \sigma_X - a_Z b_Y \sigma_Y \sigma_Z + a_Z b_Z \mathbf{1} + i(a_X b_Y - a_Y b_X) \sigma_Z \end{aligned}$$

Write the product in Gibbs notation. (This is where Gibbs got his $\{\mathbf{i}, \mathbf{j}, \mathbf{k}\}$ notation!)

$$\sigma_a \sigma_b = (\sigma \bullet \mathbf{a})(\sigma \bullet \mathbf{b}) = (\mathbf{a} \bullet \mathbf{b}) \mathbf{1} + i(\mathbf{a} \times \mathbf{b}) \bullet \sigma$$

$$\begin{aligned} \sigma_Z \cdot \sigma_X &= \begin{pmatrix} 1 & 0 \\ 0 & -1 \end{pmatrix} \begin{pmatrix} 0 & 1 \\ 1 & 0 \end{pmatrix} = \begin{pmatrix} 0 & 1 \\ -1 & 0 \end{pmatrix} = i \begin{pmatrix} 0 & -i \\ i & 0 \end{pmatrix} = i\sigma_Y \\ \sigma_X \cdot \sigma_Z &= \begin{pmatrix} 0 & 1 \\ 1 & 0 \end{pmatrix} \begin{pmatrix} 1 & 0 \\ 0 & -1 \end{pmatrix} = \begin{pmatrix} 0 & -1 \\ 1 & 0 \end{pmatrix} = -i \begin{pmatrix} 0 & -i \\ i & 0 \end{pmatrix} = -i\sigma_Y \end{aligned}$$

(Recall complex variable result.)

$$\begin{aligned} A^* B &= (A_X + iA_Y)^*(B_X + iB_Y) = (A_X - iA_Y)(B_X + iB_Y) \\ &= (A_X B_X + A_Y B_Y) + i(A_X B_Y - A_Y B_X) = (\mathbf{A} \bullet \mathbf{B}) + i(\mathbf{A} \times \mathbf{B})_Z \end{aligned}$$

Review: How C_2 (Bilateral σ_B reflection) symmetry is eigen-solver

$U(2)$ vs $R(3)$: 2-State Schrodinger: $i\hbar\partial_t|\Psi(t)\rangle = \mathbf{H}|\Psi(t)\rangle$ vs. Classical 2D-HO: $\partial_t^2\mathbf{x} = -\mathbf{K}\cdot\mathbf{x}$
Hamilton-Pauli spinor symmetry (σ -expansion in $ABCD$ -Types) $\mathbf{H} = \omega_\mu\sigma_\mu$

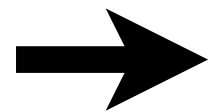

Deriving σ -exponential time evolution (or revolution) operator $\mathbf{U} = e^{-i\mathbf{H}t} = e^{-i\sigma_\mu\omega_\mu t}$

Spinor arithmetic like complex arithmetic

Spinor vector algebra like complex vector algebra

→ Spinor exponentials like complex exponentials (“Crazy-Thing”-Theorem)

Geometry of $U(2)$ evolution (or $R(3)$ revolution) operator $\mathbf{U} = e^{-i\mathbf{H}t} = e^{-i\sigma_\mu\omega_\mu t}$

The “mysterious” factors of 2 (or 1/2): 2D Spinor vs 3D Spin Vector space

2D Spinor vs 3D vector rotation

NMR Hamiltonian: 3D Spin Moment \mathbf{m} in \mathbf{B} field

Euler’s state definition using rotations $\mathbf{R}(\alpha, 0, 0)$, $\mathbf{R}(0, \beta, 0)$, and $\mathbf{R}(0, 0, \gamma)$

Spin-1 (3D-real vector) case

Spin-1/2 (2D-complex spinor) case

3D-real Stokes Vector defines 2D-HO polarization ellipses and spinor states

Asymmetry $S_A = S_Z$, Balance $S_B = S_X$, and Chirality $S_C = S_Y$

Polarization ellipse and spinor state dynamics

OBJECTIVE: Evaluate and (*most important!*) *visualize* matrix-exponent solutions.

$$|\Psi(t)\rangle = e^{-i\mathbf{H}\cdot t} |\Psi(0)\rangle$$

Hamilton generalized Euler's expansion $e^{-i\omega t} = \cos \omega t - i \sin \omega t$ so matrix exponential becomes powerful.

$$e^{-i\mathbf{H}\cdot t} = e^{-i \begin{pmatrix} A & B-iC \\ B+iC & D \end{pmatrix} \cdot t} = e^{-i \frac{A-D}{2} \begin{pmatrix} 1 & 0 \\ 0 & -1 \end{pmatrix} \cdot t} e^{-iB \begin{pmatrix} 0 & 1 \\ 1 & 0 \end{pmatrix} \cdot t} e^{-iC \begin{pmatrix} 0 & -i \\ i & 0 \end{pmatrix} \cdot t} e^{-i \frac{A+D}{2} \begin{pmatrix} 1 & 0 \\ 0 & 1 \end{pmatrix} \cdot t}$$

$\sigma_A = \sigma_Z$ $\sigma_B = \sigma_X$ $\sigma_C = \sigma_Y$

$$= e^{-i\sigma_\varphi \varphi} e^{-i\omega_0 t} = e^{-i\vec{\sigma} \cdot \vec{\omega} t} e^{-i\omega_0 t} \text{ where: } \vec{\varphi} = \begin{pmatrix} \varphi_A \\ \varphi_B \\ \varphi_C \end{pmatrix} = \vec{\omega} \cdot t = \begin{pmatrix} \omega_A \\ \omega_B \\ \omega_C \end{pmatrix} \cdot t = \begin{pmatrix} \frac{A-D}{2} \\ B \\ C \end{pmatrix} \cdot t \text{ and: } \omega_0 = \frac{A+D}{2}$$

ABCD Time evolution operator

Symmetry relations make spinors $\sigma_X = \sigma_B$, $\sigma_Y = \sigma_C$, and $\sigma_Z = \sigma_A$ or quaternions $\mathbf{i} = -i\sigma_X$, $\mathbf{j} = -i\sigma_Y$, and $\mathbf{k} = -i\sigma_Z$ powerful.

Hamilton is able to generalize Euler's complex rotation operators $e^{+i\varphi}$ and $e^{-i\varphi}$. (Recall Euler - DeMoivre Theorem.)

$$e^{-i\varphi} = 1 + (-i\varphi) + \frac{1}{2!}(-i\varphi)^2 + \frac{1}{3!}(-i\varphi)^3 + \frac{1}{4!}(-i\varphi)^4 \dots = [1 \quad -\frac{1}{2!}\varphi^2 \quad +\frac{1}{4!}\varphi^4 \dots] = [\cos \varphi]$$

$$[-i(\varphi) \quad +\frac{1}{3!}\varphi^3 \quad \dots] = -i(\sin \varphi)$$

OBJECTIVE: Evaluate and (*most important!*) *visualize* matrix-exponent solutions.

$$|\Psi(t)\rangle = e^{-i\mathbf{H}\cdot t} |\Psi(0)\rangle$$

Hamilton generalized Euler's expansion $e^{-i\omega t} = \cos \omega t - i \sin \omega t$ so matrix exponential becomes powerful.

$$e^{-i\mathbf{H}\cdot t} = e^{-i \begin{pmatrix} A & B-iC \\ B+iC & D \end{pmatrix} \cdot t} = e^{-i \frac{A-D}{2} \begin{pmatrix} 1 & 0 \\ 0 & -1 \end{pmatrix} \cdot t} \cdot e^{-iB \begin{pmatrix} 0 & 1 \\ 1 & 0 \end{pmatrix} \cdot t} \cdot e^{-iC \begin{pmatrix} 0 & -i \\ i & 0 \end{pmatrix} \cdot t} \cdot e^{-i \frac{A+D}{2} \begin{pmatrix} 1 & 0 \\ 0 & 1 \end{pmatrix} \cdot t}$$

$\sigma_A = \sigma_Z$ $\sigma_B = \sigma_X$ $\sigma_C = \sigma_Y$

$$= e^{-i\sigma_\varphi \varphi} e^{-i\omega_0 t} = e^{-i\vec{\sigma} \cdot \vec{\omega} t} e^{-i\omega_0 t} \text{ where: } \vec{\varphi} = \begin{pmatrix} \varphi_A \\ \varphi_B \\ \varphi_C \end{pmatrix} = \vec{\omega} \cdot t = \begin{pmatrix} \omega_A \\ \omega_B \\ \omega_C \end{pmatrix} \cdot t = \begin{pmatrix} \frac{A-D}{2} \\ B \\ C \end{pmatrix} \cdot t \text{ and: } \omega_0 = \frac{A+D}{2}$$

ABCD Time evolution operator

Symmetry relations make spinors $\sigma_X = \sigma_B$, $\sigma_Y = \sigma_C$, and $\sigma_Z = \sigma_A$ or quaternions $\mathbf{i} = -i\sigma_X$, $\mathbf{j} = -i\sigma_Y$, and $\mathbf{k} = -i\sigma_Z$ powerful.

Hamilton is able to generalize Euler's complex rotation operators $e^{+i\varphi}$ and $e^{-i\varphi}$. (Recall Euler - DeMoivre Theorem.)

$$e^{-i\varphi} = 1 + (-i\varphi) + \frac{1}{2!}(-i\varphi)^2 + \frac{1}{3!}(-i\varphi)^3 + \frac{1}{4!}(-i\varphi)^4 \dots = [1 - \frac{1}{2!}\varphi^2 + \frac{1}{4!}\varphi^4 \dots] = [\cos \varphi]$$

Note even powers of $(-i)$ are ± 1
and odd powers of $(-i)$ are $\pm i$:

$$(-i)^0 = +1, \quad (-i)^1 = -i, \quad (-i)^2 = -1, \quad (-i)^3 = +i, \quad (-i)^4 = +1, \quad (-i)^5 = -i, \text{ etc.}$$

OBJECTIVE: Evaluate and (*most important!*) *visualize* matrix-exponent solutions.

$$|\Psi(t)\rangle = e^{-i\mathbf{H}\cdot t} |\Psi(0)\rangle$$

Hamilton generalized Euler's expansion $e^{-i\omega t} = \cos \omega t - i \sin \omega t$ so matrix exponential becomes powerful.

$$e^{-i\mathbf{H}\cdot t} = e^{-i \begin{pmatrix} A & B-iC \\ B+iC & D \end{pmatrix} \cdot t} = e^{-i \frac{A-D}{2} \begin{pmatrix} 1 & 0 \\ 0 & -1 \end{pmatrix} \cdot t} e^{-iB \begin{pmatrix} 0 & 1 \\ 1 & 0 \end{pmatrix} \cdot t} e^{-iC \begin{pmatrix} 0 & -i \\ i & 0 \end{pmatrix} \cdot t} e^{-i \frac{A+D}{2} \begin{pmatrix} 1 & 0 \\ 0 & 1 \end{pmatrix} \cdot t}$$

$\sigma_A = \sigma_Z$ $\sigma_B = \sigma_X$ $\sigma_C = \sigma_Y$

$$= e^{-i\sigma_\varphi \varphi} e^{-i\omega_0 t} = e^{-i\vec{\sigma} \cdot \vec{\omega} t} e^{-i\omega_0 t} \text{ where: } \vec{\varphi} = \begin{pmatrix} \varphi_A \\ \varphi_B \\ \varphi_C \end{pmatrix} = \vec{\omega} \cdot t = \begin{pmatrix} \omega_A \\ \omega_B \\ \omega_C \end{pmatrix} \cdot t = \begin{pmatrix} \frac{A-D}{2} \\ B \\ C \end{pmatrix} \cdot t \text{ and: } \omega_0 = \frac{A+D}{2}$$

ABCD Time evolution operator

Symmetry relations make spinors $\sigma_X = \sigma_B$, $\sigma_Y = \sigma_C$, and $\sigma_Z = \sigma_A$ or quaternions $\mathbf{i} = -i\sigma_X$, $\mathbf{j} = -i\sigma_Y$, and $\mathbf{k} = -i\sigma_Z$ powerful.

Hamilton is able to generalize Euler's complex rotation operators $e^{+i\varphi}$ and $e^{-i\varphi}$. (Recall Euler - DeMoivre Theorem.)

$$e^{-i\varphi} = 1 + (-i\varphi) + \frac{1}{2!}(-i\varphi)^2 + \frac{1}{3!}(-i\varphi)^3 + \frac{1}{4!}(-i\varphi)^4 \dots = [1 - \frac{1}{2!}\varphi^2 + \frac{1}{4!}\varphi^4 \dots] = [\cos \varphi]$$

Note even powers of $(-i)$ are ± 1
and odd powers of $(-i)$ are $\pm i$:

$$(-i)^0 = +1, (-i)^1 = -i, (-i)^2 = -1, (-i)^3 = +i, (-i)^4 = +1, (-i)^5 = -i, \text{ etc.}$$

Hamilton replaces $(-i)$ with $-i\sigma_\varphi$ in the $e^{-i\varphi}$ power series above to get a sequence of terms just like it.

$$(-i\sigma_\varphi)^0 = +1, (-i\sigma_\varphi)^1 = -i\sigma_\varphi, (-i\sigma_\varphi)^2 = -1, (-i\sigma_\varphi)^3 = +i\sigma_\varphi, (-i\sigma_\varphi)^4 = +1, (-i\sigma_\varphi)^5 = -i\sigma_\varphi, \text{ etc.}$$

Unit spinor vector

$$\sigma_\varphi = \frac{(\vec{\sigma} \cdot \vec{\varphi})}{\varphi} = (\vec{\sigma} \cdot \hat{\varphi})\varphi$$

$$= \frac{\varphi_A \sigma_A + \varphi_B \sigma_B + \varphi_C \sigma_C}{\sqrt{\varphi_A^2 + \varphi_B^2 + \varphi_C^2}}$$

OBJECTIVE: Evaluate and (*most important!*) *visualize* matrix-exponent solutions.

$$|\Psi(t)\rangle = e^{-i\mathbf{H}\cdot t} |\Psi(0)\rangle$$

Hamilton generalized Euler's expansion $e^{-i\omega t} = \cos \omega t - i \sin \omega t$ so matrix exponential becomes powerful.

$$e^{-i\mathbf{H}\cdot t} = e^{-i \begin{pmatrix} A & B-iC \\ B+iC & D \end{pmatrix} \cdot t} = e^{-i \frac{A-D}{2} \begin{pmatrix} 1 & 0 \\ 0 & -1 \end{pmatrix} \cdot t} e^{-iB \begin{pmatrix} 0 & 1 \\ 1 & 0 \end{pmatrix} \cdot t} e^{-iC \begin{pmatrix} 0 & -i \\ i & 0 \end{pmatrix} \cdot t} e^{-i \frac{A+D}{2} \begin{pmatrix} 1 & 0 \\ 0 & 1 \end{pmatrix} \cdot t}$$

$\sigma_A = \sigma_Z$ $\sigma_B = \sigma_X$ $\sigma_C = \sigma_Y$

$$= e^{-i\sigma_\varphi \varphi} e^{-i\omega_0 t} = e^{-i\vec{\sigma} \cdot \vec{\omega} t} e^{-i\omega_0 t} \text{ where: } \vec{\varphi} = \begin{pmatrix} \varphi_A \\ \varphi_B \\ \varphi_C \end{pmatrix} = \vec{\omega} \cdot t = \begin{pmatrix} \omega_A \\ \omega_B \\ \omega_C \end{pmatrix} \cdot t = \begin{pmatrix} \frac{A-D}{2} \\ B \\ C \end{pmatrix} \cdot t \text{ and: } \omega_0 = \frac{A+D}{2}$$

ABCD Time evolution operator

Symmetry relations make spinors $\sigma_X = \sigma_B$, $\sigma_Y = \sigma_C$, and $\sigma_Z = \sigma_A$ or quaternions $\mathbf{i} = -i\sigma_X$, $\mathbf{j} = -i\sigma_Y$, and $\mathbf{k} = -i\sigma_Z$ powerful.

Hamilton is able to generalize Euler's complex rotation operators $e^{+i\varphi}$ and $e^{-i\varphi}$. (Recall Euler - DeMoivre Theorem.)

$$e^{-i\varphi} = 1 + (-i\varphi) + \frac{1}{2!}(-i\varphi)^2 + \frac{1}{3!}(-i\varphi)^3 + \frac{1}{4!}(-i\varphi)^4 \dots = [1 - \frac{1}{2!}\varphi^2 + \frac{1}{4!}\varphi^4 \dots] = [\cos \varphi]$$

$$-i(\varphi + \frac{1}{3!}\varphi^3 \dots) = -i(\sin \varphi)$$

Note even powers of $(-i)$ are ± 1 and odd powers of $(-i)$ are $\pm i$: $(-i)^0 = +1$, $(-i)^1 = -i$, $(-i)^2 = -1$, $(-i)^3 = +i$, $(-i)^4 = +1$, $(-i)^5 = -i$, etc.

Hamilton replaces $(-i)$ with $-i\sigma_\varphi$ in the $e^{-i\varphi}$ power series above to get a sequence of terms just like it.

$$(-i\sigma_\varphi)^0 = +1, (-i\sigma_\varphi)^1 = -i\sigma_\varphi, (-i\sigma_\varphi)^2 = -1, (-i\sigma_\varphi)^3 = +i\sigma_\varphi, (-i\sigma_\varphi)^4 = +1, (-i\sigma_\varphi)^5 = -i\sigma_\varphi, \text{ etc.}$$

This allows Hamilton to generalize Euler's rotation $e^{-i\varphi}$ to $e^{-i\sigma_\varphi \varphi}$ for any $\sigma_\varphi \varphi = (\sigma \cdot \vec{\varphi}) = \varphi_A \sigma_A + \varphi_B \sigma_B + \varphi_Z \sigma_Z = (\sigma \cdot \hat{\varphi}) \varphi$

$$e^{-i\varphi} = 1 \cos \varphi - i \sin \varphi$$

generalizes to: $e^{-i\sigma_\varphi \varphi} = 1 \cos \varphi - i \sigma_\varphi \sin \varphi$

Unit spinor vector

$$\sigma_\varphi = \frac{(\sigma \cdot \vec{\varphi})}{\varphi} = (\sigma \cdot \hat{\varphi}) \varphi$$

$$= \frac{\varphi_A \sigma_A + \varphi_B \sigma_B + \varphi_C \sigma_C}{\sqrt{\varphi_A^2 + \varphi_B^2 + \varphi_C^2}}$$

OBJECTIVE: Evaluate and (*most important!*) *visualize* matrix-exponent solutions.

$$|\Psi(t)\rangle = e^{-i\mathbf{H}\cdot t} |\Psi(0)\rangle$$

Hamilton generalized Euler's expansion $e^{-i\omega t} = \cos \omega t - i \sin \omega t$ so matrix exponential becomes powerful.

$$e^{-i\mathbf{H}\cdot t} = e^{-i \begin{pmatrix} A & B-iC \\ B+iC & D \end{pmatrix} \cdot t} = e^{-i \frac{A-D}{2} \begin{pmatrix} 1 & 0 \\ 0 & -1 \end{pmatrix} \cdot t} e^{-iB \begin{pmatrix} 0 & 1 \\ 1 & 0 \end{pmatrix} \cdot t} e^{-iC \begin{pmatrix} 0 & -i \\ i & 0 \end{pmatrix} \cdot t} e^{-i \frac{A+D}{2} \begin{pmatrix} 1 & 0 \\ 0 & 1 \end{pmatrix} \cdot t}$$

$\sigma_A = \sigma_Z$ $\sigma_B = \sigma_X$ $\sigma_C = \sigma_Y$

$$= e^{-i\sigma_\varphi \varphi} e^{-i\omega_0 t} = e^{-i\vec{\sigma} \cdot \vec{\omega} t} e^{-i\omega_0 t} \text{ where: } \vec{\varphi} = \begin{pmatrix} \varphi_A \\ \varphi_B \\ \varphi_C \end{pmatrix} = \vec{\omega} \cdot t = \begin{pmatrix} \omega_A \\ \omega_B \\ \omega_C \end{pmatrix} \cdot t = \begin{pmatrix} \frac{A-D}{2} \\ B \\ C \end{pmatrix} \cdot t \text{ and: } \omega_0 = \frac{A+D}{2}$$

$$= (\mathbf{1} \cos \varphi - i \sigma_\varphi \sin \varphi) e^{-i\omega_0 t}$$

ABCD Time evolution operator

Symmetry relations make spinors $\sigma_X = \sigma_B$, $\sigma_Y = \sigma_C$, and $\sigma_Z = \sigma_A$ or quaternions $\mathbf{i} = -i\sigma_X$, $\mathbf{j} = -i\sigma_Y$, and $\mathbf{k} = -i\sigma_Z$ powerful.

Hamilton is able to generalize Euler's complex rotation operators $e^{+i\varphi}$ and $e^{-i\varphi}$. (Recall Euler - DeMoivre Theorem.)

$$e^{-i\varphi} = 1 + (-i\varphi) + \frac{1}{2!}(-i\varphi)^2 + \frac{1}{3!}(-i\varphi)^3 + \frac{1}{4!}(-i\varphi)^4 \dots = [1 - \frac{1}{2!}\varphi^2 + \frac{1}{4!}\varphi^4 \dots] = [\cos \varphi]$$

$$[-i\varphi + \frac{1}{3!}\varphi^3 \dots] = -i(\sin \varphi)$$

Note even powers of $(-i)$ are ± 1 and odd powers of $(-i)$ are $\pm i$: $(-i)^0 = +1$, $(-i)^1 = -i$, $(-i)^2 = -1$, $(-i)^3 = +i$, $(-i)^4 = +1$, $(-i)^5 = -i$, etc.

Hamilton replaces $(-i)$ with $-i\sigma_\varphi$ in the $e^{-i\varphi}$ power series above to get a sequence of terms just like it.

$$(-i\sigma_\varphi)^0 = +\mathbf{1}, (-i\sigma_\varphi)^1 = -i\sigma_\varphi, (-i\sigma_\varphi)^2 = -\mathbf{1}, (-i\sigma_\varphi)^3 = +i\sigma_\varphi, (-i\sigma_\varphi)^4 = +\mathbf{1}, (-i\sigma_\varphi)^5 = -i\sigma_\varphi, \text{ etc.}$$

This allows Hamilton to generalize Euler's rotation $e^{-i\varphi}$ to $e^{-i\sigma_\varphi \varphi}$ for any $\sigma_\varphi \varphi = (\vec{\sigma} \cdot \vec{\varphi}) = \varphi_A \sigma_A + \varphi_B \sigma_B + \varphi_C \sigma_C = (\vec{\sigma} \cdot \vec{\hat{\varphi}}) \varphi$

$$e^{-i\varphi} = \mathbf{1} \cos \varphi - i \sin \varphi \quad \text{generalizes to:} \quad e^{-i\sigma_\varphi \varphi} = \mathbf{1} \cos \varphi - i \sigma_\varphi \sin \varphi$$

The Crazy Thing Theorem:
 If $(\text{smiley})^2 = -\mathbf{1}$
 Then:
 $e^{(\text{smiley})\varphi} = \mathbf{1} \cos \varphi + (\text{smiley}) \sin \varphi$

OBJECTIVE: Evaluate and (*most important!*) *visualize* matrix-exponent solutions.

$$|\Psi(t)\rangle = e^{-i\mathbf{H}\cdot t} |\Psi(0)\rangle$$

Hamilton generalized Euler's expansion $e^{-i\omega t} = \cos \omega t - i \sin \omega t$ so matrix exponential becomes powerful.

$$e^{-i\mathbf{H}\cdot t} = e^{-i \begin{pmatrix} A & B-iC \\ B+iC & D \end{pmatrix} \cdot t} = e^{-i \frac{A-D}{2} \begin{pmatrix} 1 & 0 \\ 0 & -1 \end{pmatrix} \cdot t} e^{-iB \begin{pmatrix} 0 & 1 \\ 1 & 0 \end{pmatrix} \cdot t} e^{-iC \begin{pmatrix} 0 & -i \\ i & 0 \end{pmatrix} \cdot t} e^{-i \frac{A+D}{2} \begin{pmatrix} 1 & 0 \\ 0 & 1 \end{pmatrix} \cdot t}$$

$\sigma_A = \sigma_Z$ $\sigma_B = \sigma_X$ $\sigma_C = \sigma_Y$

$$= e^{-i\sigma_\varphi \varphi} e^{-i\omega_0 t} = e^{-i\vec{\sigma} \cdot \vec{\omega} t} e^{-i\omega_0 t} \text{ where: } \vec{\varphi} = \begin{pmatrix} \varphi_A \\ \varphi_B \\ \varphi_C \end{pmatrix} = \vec{\omega} \cdot t = \begin{pmatrix} \omega_A \\ \omega_B \\ \omega_C \end{pmatrix} \cdot t = \begin{pmatrix} \frac{A-D}{2} \\ B \\ C \end{pmatrix} \cdot t \text{ and: } \omega_0 = \frac{A+D}{2}$$

$$= (\mathbf{1} \cos \varphi - i \sigma_\varphi \sin \varphi) e^{-i\omega_0 t}$$

ABCD Time evolution operator

Symmetry relations make spinors $\sigma_X = \sigma_B$, $\sigma_Y = \sigma_C$, and $\sigma_Z = \sigma_A$ or quaternions $\mathbf{i} = -i\sigma_X$, $\mathbf{j} = -i\sigma_Y$, and $\mathbf{k} = -i\sigma_Z$ powerful.

Hamilton is able to generalize Euler's complex rotation operators $e^{+i\varphi}$ and $e^{-i\varphi}$. (Recall Euler - DeMoivre Theorem.)

$$e^{-i\varphi} = 1 + (-i\varphi) + \frac{1}{2!}(-i\varphi)^2 + \frac{1}{3!}(-i\varphi)^3 + \frac{1}{4!}(-i\varphi)^4 \dots = [1 - \frac{1}{2!}\varphi^2 + \frac{1}{4!}\varphi^4 \dots] = [\cos \varphi]$$

$$[-i\varphi + \frac{1}{3!}\varphi^3 \dots] = [-i(\sin \varphi)]$$

Note even powers of $(-i)$ are ± 1 and odd powers of $(-i)$ are $\pm i$: $(-i)^0 = +1$, $(-i)^1 = -i$, $(-i)^2 = -1$, $(-i)^3 = +i$, $(-i)^4 = +1$, $(-i)^5 = -i$, etc.

Hamilton replaces $(-i)$ with $-i\sigma_\varphi$ in the $e^{-i\varphi}$ power series above to get a sequence of terms just like it.

$$(-i\sigma_\varphi)^0 = +1, (-i\sigma_\varphi)^1 = -i\sigma_\varphi, (-i\sigma_\varphi)^2 = -1, (-i\sigma_\varphi)^3 = +i\sigma_\varphi, (-i\sigma_\varphi)^4 = +1, (-i\sigma_\varphi)^5 = -i\sigma_\varphi, \text{ etc.}$$

This allows Hamilton to generalize Euler's rotation $e^{-i\varphi}$ to $e^{-i\sigma_\varphi \varphi}$ for any $\sigma_\varphi \varphi = (\sigma \cdot \vec{\varphi}) = \varphi_A \sigma_A + \varphi_B \sigma_B + \varphi_Z \sigma_Z = (\sigma \cdot \hat{\varphi}) \varphi$

$$e^{-i\varphi} = 1 \cos \varphi - i \sin \varphi \quad \text{generalizes to:} \quad e^{-i\sigma_\varphi \varphi} = 1 \cos \varphi - i \sigma_\varphi \sin \varphi$$

Here:  = $-i$
Crazy thing is just $-\sqrt{-1}$

Here:  = $-i\sigma_\varphi = -i(\sigma \cdot \hat{\varphi}) = -i \frac{(\sigma \cdot \vec{\varphi})}{\varphi}$

The Crazy Thing Theorem:
If $(\text{smiley face})^2 = -1$
Then:
 $e^{(\text{smiley face})\varphi} = 1 \cos \varphi + (\text{smiley face}) \sin \varphi$

Review: How C_2 (Bilateral σ_B reflection) symmetry is eigen-solver

$U(2)$ vs $R(3)$: 2-State Schrodinger: $i\hbar\partial_t|\Psi(t)\rangle = \mathbf{H}|\Psi(t)\rangle$ vs. Classical 2D-HO: $\partial_t^2\mathbf{x} = -\mathbf{K}\cdot\mathbf{x}$

Hamilton-Pauli spinor symmetry (σ -expansion in $ABCD$ -Types) $\mathbf{H} = \omega_\mu \sigma_\mu$

Deriving σ -exponential time evolution (or revolution) operator $\mathbf{U} = e^{-i\mathbf{H}t} = e^{-i\sigma_\mu \omega_\mu t}$

Spinor arithmetic like complex arithmetic

Spinor vector algebra like complex vector algebra

Spinor exponentials like complex exponentials ("Crazy-Thing"-Theorem)

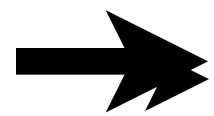

Geometry of $U(2)$ evolution (or $R(3)$ revolution) operator $\mathbf{U} = e^{-i\mathbf{H}t} = e^{-i\sigma_\mu \omega_\mu t}$

The "mysterious" factors of 2 (or 1/2): 2D Spinor vs 3D Spin Vector space

2D Spinor vs 3D vector rotation

NMR Hamiltonian: 3D Spin Moment \mathbf{m} in \mathbf{B} field

Euler's state definition using rotations $\mathbf{R}(\alpha, 0, 0)$, $\mathbf{R}(0, \beta, 0)$, and $\mathbf{R}(0, 0, \gamma)$

Spin-1 (3D-real vector) case

Spin-1/2 (2D-complex spinor) case

3D-real Stokes Vector defines 2D-HO polarization ellipses and spinor states

Asymmetry $S_A = S_Z$, Balance $S_B = S_X$, and Chirality $S_C = S_Y$

Polarization ellipse and spinor state dynamics

OBJECTIVE: Evaluate and (*most important!*) *visualize* matrix-exponent solutions.

ABCD Time evolution operator

$$|\Psi(t)\rangle = e^{-i\mathbf{H}\cdot t} |\Psi(0)\rangle$$

Hamilton generalized Euler's expansion $e^{-i\Omega t} = \cos \Omega t - i \sin \Omega t$ so matrix exponential becomes powerful.

$$e^{-i\mathbf{H}\cdot t} = e^{-i \begin{pmatrix} A & B-iC \\ B+iC & D \end{pmatrix} \cdot t} = e^{-i \frac{A-D}{2} \begin{pmatrix} 1 & 0 \\ 0 & -1 \end{pmatrix} \cdot t} \cdot e^{-iB \begin{pmatrix} 0 & 1 \\ 1 & 0 \end{pmatrix} \cdot t} \cdot e^{-iC \begin{pmatrix} 0 & -i \\ i & 0 \end{pmatrix} \cdot t} \cdot e^{-i \frac{A+D}{2} \begin{pmatrix} 1 & 0 \\ 0 & 1 \end{pmatrix} \cdot t} = e^{-i(\omega_0 \sigma_0 + \vec{\omega} \cdot \vec{\sigma}) \cdot t} = e^{-i\omega_0 t} (\mathbf{1} \cos \omega t - i \sigma_\varphi \sin \omega t)$$

$\sigma_A = \sigma_Z$ $\sigma_B = \sigma_X$ $\sigma_C = \sigma_Y$

where: $\vec{\varphi} = \begin{pmatrix} \varphi_A \\ \varphi_B \\ \varphi_C \end{pmatrix} = \vec{\omega} \cdot t = \begin{pmatrix} \omega_A \\ \omega_B \\ \omega_C \end{pmatrix} \cdot t = \begin{pmatrix} \frac{A-D}{2} \\ B \\ C \end{pmatrix} \cdot t$ and: $\omega_0 = \frac{A+D}{2}$

$$e^{-i\varphi} = \mathbf{1} \cos \varphi - i \sin \varphi$$

generalizes to:

$$e^{-i\sigma_\varphi \varphi} = \mathbf{1} \cos \varphi - i \sigma_\varphi \sin \varphi$$

$$e^{-i \begin{pmatrix} 1 & 0 \\ 0 & -1 \end{pmatrix} \varphi_A} = \begin{pmatrix} 1 & 0 \\ 0 & 1 \end{pmatrix} \cos \varphi_A - i \begin{pmatrix} 1 & 0 \\ 0 & -1 \end{pmatrix} \sin \varphi_A$$

$$= \begin{pmatrix} \cos \varphi_A - i \sin \varphi_A & 0 \\ 0 & \cos \varphi_A + i \sin \varphi_A \end{pmatrix} = \begin{pmatrix} e^{-i\varphi_A} & 0 \\ 0 & e^{i\varphi_A} \end{pmatrix}$$

Example 1:
A or Z rotation

The Crazy Thing Theorem:
If $(i)^2 = -1$
Then:
 $e^{i\varphi} = \mathbf{1} \cos \varphi + i \sin \varphi$

OBJECTIVE: Evaluate and (*most important!*) *visualize* matrix-exponent solutions.

ABCD Time evolution operator

$$|\Psi(t)\rangle = e^{-i\mathbf{H}\cdot t} |\Psi(0)\rangle$$

Hamilton generalized Euler's expansion $e^{-i\Omega t} = \cos \Omega t - i \sin \Omega t$ so matrix exponential becomes powerful.

$$e^{-i\mathbf{H}\cdot t} = e^{-i \begin{pmatrix} A & B-iC \\ B+iC & D \end{pmatrix} \cdot t} = e^{-i \frac{A-D}{2} \begin{pmatrix} 1 & 0 \\ 0 & -1 \end{pmatrix} \cdot t - iB \begin{pmatrix} 0 & 1 \\ 1 & 0 \end{pmatrix} \cdot t - iC \begin{pmatrix} 0 & -i \\ i & 0 \end{pmatrix} \cdot t - i \frac{A+D}{2} \begin{pmatrix} 1 & 0 \\ 0 & 1 \end{pmatrix} \cdot t} = e^{-i(\omega_0 \sigma_0 + \vec{\omega} \cdot \vec{\sigma}) \cdot t} = e^{-i\omega_0 t} (1 \cos \omega t - i \sigma_\varphi \sin \omega t)$$

$\sigma_A = \sigma_Z$ $\sigma_B = \sigma_X$ $\sigma_C = \sigma_Y$

where: $\vec{\varphi} = \begin{pmatrix} \varphi_A \\ \varphi_B \\ \varphi_C \end{pmatrix} = \vec{\omega} \cdot t = \begin{pmatrix} \omega_A \\ \omega_B \\ \omega_C \end{pmatrix} \cdot t = \begin{pmatrix} \frac{A-D}{2} \\ B \\ C \end{pmatrix} \cdot t$ and: $\omega_0 = \frac{A+D}{2}$

$$e^{-i\varphi} = 1 \cos \varphi - i \sin \varphi$$

generalizes to:

$$e^{-i\sigma_\varphi \varphi} = 1 \cos \varphi - i \sigma_\varphi \sin \varphi$$

$$e^{-i \begin{pmatrix} 1 & 0 \\ 0 & -1 \end{pmatrix} \varphi_A} = \begin{pmatrix} 1 & 0 \\ 0 & 1 \end{pmatrix} \cos \varphi_A - i \begin{pmatrix} 1 & 0 \\ 0 & -1 \end{pmatrix} \sin \varphi_A$$

$$= \begin{pmatrix} \cos \varphi_A & -i \sin \varphi_A & 0 \\ 0 & \cos \varphi_A & -i \sin \varphi_A \end{pmatrix} = \begin{pmatrix} e^{-i\varphi_A} & 0 \\ 0 & e^{i\varphi_A} \end{pmatrix}$$

Example 1:
A or Z
rotation

$$e^{-i \begin{pmatrix} 0 & -i \\ i & 0 \end{pmatrix} \varphi_C} = \begin{pmatrix} 1 & 0 \\ 0 & 1 \end{pmatrix} \cos \varphi_C - i \begin{pmatrix} 0 & -i \\ i & 0 \end{pmatrix} \sin \varphi_C$$

$$= \begin{pmatrix} \cos \varphi_C & -\sin \varphi_C \\ \sin \varphi_C & \cos \varphi_C \end{pmatrix}$$

Example 2:
C or Y
rotation

The Crazy Thing Theorem:

If $(\text{🤪})^2 = -\mathbf{1}$

Then:

$$e^{(\text{🤪})\varphi} = 1 \cos \varphi + (\text{🤪}) \sin \varphi$$

OBJECTIVE: Evaluate and (*most important!*) *visualize* matrix-exponent solutions.

ABCD Time evolution operator

$$|\Psi(t)\rangle = e^{-i\mathbf{H}\cdot t} |\Psi(0)\rangle$$

Hamilton generalized Euler's expansion $e^{-i\Omega t} = \cos \Omega t - i \sin \Omega t$ so matrix exponential becomes powerful.

$$e^{-i\mathbf{H}\cdot t} = e^{-i \begin{pmatrix} A & B-iC \\ B+iC & D \end{pmatrix} \cdot t} = e^{-i \frac{A-D}{2} \begin{pmatrix} 1 & 0 \\ 0 & -1 \end{pmatrix} \cdot t} e^{-iB \begin{pmatrix} 0 & 1 \\ 1 & 0 \end{pmatrix} \cdot t} e^{-iC \begin{pmatrix} 0 & -i \\ i & 0 \end{pmatrix} \cdot t} e^{-i \frac{A+D}{2} \begin{pmatrix} 1 & 0 \\ 0 & 1 \end{pmatrix} \cdot t} = e^{-i(\omega_0 \sigma_0 + \vec{\omega} \cdot \vec{\sigma}) \cdot t} = e^{-i\omega_0 t} \left(\mathbf{1} \cos \omega t - i \sigma_\varphi \sin \omega t \right)$$

$\sigma_A = \sigma_Z$ $\sigma_B = \sigma_X$ $\sigma_C = \sigma_Y$

$$e^{-i\varphi} = 1 \cos \varphi - i \sin \varphi$$

generalizes to:

$$e^{-i\sigma_\varphi \varphi} = \mathbf{1} \cos \varphi - i \sigma_\varphi \sin \varphi$$

where: $\vec{\varphi} = \begin{pmatrix} \varphi_A \\ \varphi_B \\ \varphi_C \end{pmatrix} = \vec{\omega} \cdot t = \begin{pmatrix} \omega_A \\ \omega_B \\ \omega_C \end{pmatrix} \cdot t = \begin{pmatrix} \frac{A-D}{2} \\ B \\ C \end{pmatrix} \cdot t$ and: $\omega_0 = \frac{A+D}{2}$

$$e^{-i \begin{pmatrix} 1 & 0 \\ 0 & -1 \end{pmatrix} \varphi_A} = \begin{pmatrix} 1 & 0 \\ 0 & 1 \end{pmatrix} \cos \varphi_A - i \begin{pmatrix} 1 & 0 \\ 0 & -1 \end{pmatrix} \sin \varphi_A$$

$$= \begin{pmatrix} \cos \varphi_A - i \sin \varphi_A & 0 \\ 0 & \cos \varphi_A - i \sin \varphi_A \end{pmatrix} = \begin{pmatrix} e^{-i\varphi_A} & 0 \\ 0 & e^{i\varphi_A} \end{pmatrix}$$

Example 1:
A or Z
rotation

$$e^{-i \begin{pmatrix} 0 & -i \\ i & 0 \end{pmatrix} \varphi_C} = \begin{pmatrix} 1 & 0 \\ 0 & 1 \end{pmatrix} \cos \varphi_C - i \begin{pmatrix} 0 & -i \\ i & 0 \end{pmatrix} \sin \varphi_C$$

$$= \begin{pmatrix} \cos \varphi_C & -\sin \varphi_C \\ \sin \varphi_C & \cos \varphi_C \end{pmatrix}$$

Example 2:
C or Y
rotation

Example 3:
Any $\varphi = \omega t$ -axial rotation

Let: $\vec{\varphi} = \vec{\omega} \cdot t$

$$e^{-i(\sigma \cdot \vec{\varphi})t} = \mathbf{1} \cos \varphi - i \sigma_\varphi \sin \varphi = \mathbf{1} \cos \varphi - i (\sigma \cdot \hat{\varphi}) \sin \varphi$$

$$= \mathbf{1} \cos \varphi - i (\sigma_A \hat{\varphi}_A) \sin \varphi - i (\sigma_B \hat{\varphi}_B) \sin \varphi - i (\sigma_C \hat{\varphi}_C) \sin \varphi$$

$$= \begin{pmatrix} 1 & 0 \\ 0 & 1 \end{pmatrix} \cos \varphi - i \begin{pmatrix} 1 & 0 \\ 0 & -1 \end{pmatrix} \hat{\varphi}_A \sin \varphi - i \begin{pmatrix} 0 & 1 \\ 1 & 0 \end{pmatrix} \hat{\varphi}_B \sin \varphi - i \begin{pmatrix} 0 & -i \\ i & 0 \end{pmatrix} \hat{\varphi}_C \sin \varphi$$

$$= \begin{pmatrix} \cos \varphi - i \hat{\varphi}_A \sin \varphi & (-i \hat{\varphi}_B - \hat{\varphi}_C) \sin \varphi \\ (-i \hat{\varphi}_B + \hat{\varphi}_C) \sin \varphi & \cos \varphi + i \hat{\varphi}_A \sin \varphi \end{pmatrix}$$

The Crazy Thing Theorem:
If $(\text{smiley})^2 = -\mathbf{1}$

Then:
 $e^{(\text{smiley})\theta} = \mathbf{1} \cos \theta + (\text{smiley}) \sin \theta$

OBJECTIVE: Evaluate and (*most important!*) *visualize* matrix-exponent solutions.

ABCD Time evolution operator

$$|\Psi(t)\rangle = e^{-i\mathbf{H}\cdot t} |\Psi(0)\rangle$$

Hamilton generalized Euler's expansion $e^{-i\Omega t} = \cos \Omega t - i \sin \Omega t$ so matrix exponential becomes powerful.

$$e^{-i\mathbf{H}\cdot t} = e^{-i \begin{pmatrix} A & B-iC \\ B+iC & D \end{pmatrix} \cdot t} = e^{-i \frac{A-D}{2} \begin{pmatrix} 1 & 0 \\ 0 & -1 \end{pmatrix} \cdot t} \cdot e^{-iB \begin{pmatrix} 0 & 1 \\ 1 & 0 \end{pmatrix} \cdot t} \cdot e^{-iC \begin{pmatrix} 0 & -i \\ i & 0 \end{pmatrix} \cdot t} \cdot e^{-i \frac{A+D}{2} \begin{pmatrix} 1 & 0 \\ 0 & 1 \end{pmatrix} \cdot t} = e^{-i(\omega_0 \sigma_0 + \vec{\omega} \cdot \vec{\sigma}) \cdot t} = e^{-i\omega_0 t} \left(\mathbf{1} \cos \omega t - i \sigma_\varphi \sin \omega t \right)$$

$\sigma_A = \sigma_Z$ $\sigma_B = \sigma_X$ $\sigma_C = \sigma_Y$

$$e^{-i\varphi} = \mathbf{1} \cos \varphi - i \sin \varphi$$

generalizes to:

$$e^{-i\sigma_\varphi \varphi} = \mathbf{1} \cos \varphi - i \sigma_\varphi \sin \varphi$$

where: $\vec{\varphi} = \begin{pmatrix} \varphi_A \\ \varphi_B \\ \varphi_C \end{pmatrix} = \vec{\omega} \cdot t = \begin{pmatrix} \omega_A \\ \omega_B \\ \omega_C \end{pmatrix} \cdot t = \begin{pmatrix} \frac{A-D}{2} \\ B \\ C \end{pmatrix} \cdot t$ and: $\omega_0 = \frac{A+D}{2}$

$$e^{-i \begin{pmatrix} 1 & 0 \\ 0 & -1 \end{pmatrix} \varphi_A} = \begin{pmatrix} 1 & 0 \\ 0 & 1 \end{pmatrix} \cos \varphi_A - i \begin{pmatrix} 1 & 0 \\ 0 & -1 \end{pmatrix} \sin \varphi_A$$

$$= \begin{pmatrix} \cos \varphi_A & -i \sin \varphi_A & 0 \\ 0 & \cos \varphi_A & -i \sin \varphi_A \end{pmatrix} = \begin{pmatrix} e^{-i\varphi_A} & 0 \\ 0 & e^{i\varphi_A} \end{pmatrix}$$

Example 1:
A or Z
rotation

$$e^{-i \begin{pmatrix} 0 & -i \\ i & 0 \end{pmatrix} \varphi_C} = \begin{pmatrix} 1 & 0 \\ 0 & 1 \end{pmatrix} \cos \varphi_C - i \begin{pmatrix} 0 & -i \\ i & 0 \end{pmatrix} \sin \varphi_C$$

$$= \begin{pmatrix} \cos \varphi_C & -\sin \varphi_C \\ \sin \varphi_C & \cos \varphi_C \end{pmatrix}$$

Example 2:
C or Y
rotation

We test these operators by making them rotate each other....

OBJECTIVE: Evaluate and (*most important!*) *visualize* matrix-exponent solutions.

ABCD Time evolution operator

$$|\Psi(t)\rangle = e^{-i\mathbf{H}\cdot t} |\Psi(0)\rangle$$

Hamilton generalized Euler's expansion $e^{-i\Omega t} = \cos \Omega t - i \sin \Omega t$ so matrix exponential becomes powerful.

$$e^{-i\mathbf{H}\cdot t} = e^{-i \begin{pmatrix} A & B-iC \\ B+iC & D \end{pmatrix} \cdot t} = e^{-i \frac{A-D}{2} \begin{pmatrix} 1 & 0 \\ 0 & -1 \end{pmatrix} \cdot t} e^{-iB \begin{pmatrix} 0 & 1 \\ 1 & 0 \end{pmatrix} \cdot t} e^{-iC \begin{pmatrix} 0 & -i \\ i & 0 \end{pmatrix} \cdot t} e^{-i \frac{A+D}{2} \begin{pmatrix} 1 & 0 \\ 0 & 1 \end{pmatrix} \cdot t} = e^{-i(\omega_0 \sigma_0 + \vec{\omega} \cdot \vec{\sigma}) \cdot t} = e^{-i\omega_0 t} (\mathbf{1} \cos \omega t - i \sigma_\varphi \sin \omega t)$$

$\sigma_A = \sigma_Z$ $\sigma_B = \sigma_X$ $\sigma_C = \sigma_Y$

$$e^{-i\varphi} = \mathbf{1} \cos \varphi - i \sin \varphi$$

generalizes to:

$$e^{-i\sigma_\varphi \varphi} = \mathbf{1} \cos \varphi - i \sigma_\varphi \sin \varphi$$

where: $\vec{\varphi} = \begin{pmatrix} \varphi_A \\ \varphi_B \\ \varphi_C \end{pmatrix} = \vec{\omega} \cdot t = \begin{pmatrix} \omega_A \\ \omega_B \\ \omega_C \end{pmatrix} \cdot t = \begin{pmatrix} \frac{A-D}{2} \\ B \\ C \end{pmatrix} \cdot t$ and: $\omega_0 = \frac{A+D}{2}$

$$e^{-i \begin{pmatrix} 1 & 0 \\ 0 & -1 \end{pmatrix} \varphi_A} = \begin{pmatrix} 1 & 0 \\ 0 & 1 \end{pmatrix} \cos \varphi_A - i \begin{pmatrix} 1 & 0 \\ 0 & -1 \end{pmatrix} \sin \varphi_A$$

$$= \begin{pmatrix} \cos \varphi_A - i \sin \varphi_A & 0 \\ 0 & \cos \varphi_A - i \sin \varphi_A \end{pmatrix} = \begin{pmatrix} e^{-i\varphi_A} & 0 \\ 0 & e^{i\varphi_A} \end{pmatrix}$$

Example 1:
A or Z
rotation

$$e^{-i \begin{pmatrix} 0 & -i \\ i & 0 \end{pmatrix} \varphi_C} = \begin{pmatrix} 1 & 0 \\ 0 & 1 \end{pmatrix} \cos \varphi_C - i \begin{pmatrix} 0 & -i \\ i & 0 \end{pmatrix} \sin \varphi_C$$

$$= \begin{pmatrix} \cos \varphi_C & -\sin \varphi_C \\ \sin \varphi_C & \cos \varphi_C \end{pmatrix}$$

Example 2:
C or Y
rotation

3D axis vector $\vec{\varphi} = \vec{\omega} \cdot t$ corresponds to generator $\sigma_\varphi = \sigma_A \hat{\varphi}_A + \sigma_B \hat{\varphi}_B + \sigma_C \hat{\varphi}_C$ of rotation $e^{-i\sigma_\varphi \varphi} = R(\vec{\varphi}) = \mathbf{1} \cos \varphi - i \sigma_\varphi \sin \varphi$ about axis $\vec{\varphi}$.

OBJECTIVE: Evaluate and (*most important!*) *visualize* matrix-exponent solutions.

ABCD Time evolution operator

$$|\Psi(t)\rangle = e^{-i\mathbf{H}\cdot t} |\Psi(0)\rangle$$

Hamilton generalized Euler's expansion $e^{-i\Omega t} = \cos \Omega t - i \sin \Omega t$ so matrix exponential becomes powerful.

$$e^{-i\mathbf{H}\cdot t} = e^{-i \begin{pmatrix} A & B-iC \\ B+iC & D \end{pmatrix} \cdot t} = e^{-i \frac{A-D}{2} \begin{pmatrix} 1 & 0 \\ 0 & -1 \end{pmatrix} \cdot t - iB \begin{pmatrix} 0 & 1 \\ 1 & 0 \end{pmatrix} \cdot t - iC \begin{pmatrix} 0 & -i \\ i & 0 \end{pmatrix} \cdot t - i \frac{A+D}{2} \begin{pmatrix} 1 & 0 \\ 0 & 1 \end{pmatrix} \cdot t} = e^{-i(\omega_0 \sigma_0 + \vec{\omega} \cdot \vec{\sigma}) \cdot t} = e^{-i\omega_0 t} (\mathbf{1} \cos \omega t - i \sigma_\varphi \sin \omega t)$$

$\sigma_A = \sigma_Z$ $\sigma_B = \sigma_X$ $\sigma_C = \sigma_Y$

$$e^{-i\varphi} = 1 \cos \varphi - i \sin \varphi$$

generalizes to:

$$e^{-i\sigma_\varphi \varphi} = \mathbf{1} \cos \varphi - i \sigma_\varphi \sin \varphi$$

where: $\vec{\varphi} = \begin{pmatrix} \varphi_A \\ \varphi_B \\ \varphi_C \end{pmatrix} = \vec{\omega} \cdot t = \begin{pmatrix} \omega_A \\ \omega_B \\ \omega_C \end{pmatrix} \cdot t = \begin{pmatrix} \frac{A-D}{2} \\ B \\ C \end{pmatrix} \cdot t$ and: $\omega_0 = \frac{A+D}{2}$

$$e^{-i \begin{pmatrix} 1 & 0 \\ 0 & -1 \end{pmatrix} \varphi_A} = \begin{pmatrix} 1 & 0 \\ 0 & 1 \end{pmatrix} \cos \varphi_A - i \begin{pmatrix} 1 & 0 \\ 0 & -1 \end{pmatrix} \sin \varphi_A$$

$$= \begin{pmatrix} \cos \varphi_A & -i \sin \varphi_A & 0 \\ 0 & \cos \varphi_A & -i \sin \varphi_A \end{pmatrix} = \begin{pmatrix} e^{-i\varphi_A} & 0 \\ 0 & e^{i\varphi_A} \end{pmatrix}$$

Example 1:
A or Z
rotation

$$e^{-i \begin{pmatrix} 0 & -i \\ i & 0 \end{pmatrix} \varphi_C} = \begin{pmatrix} 1 & 0 \\ 0 & 1 \end{pmatrix} \cos \varphi_C - i \begin{pmatrix} 0 & -i \\ i & 0 \end{pmatrix} \sin \varphi_C$$

$$= \begin{pmatrix} \cos \varphi_C & -\sin \varphi_C \\ \sin \varphi_C & \cos \varphi_C \end{pmatrix}$$

Example 2:
C or Y
rotation

3D axis vector $\vec{\varphi} = \vec{\omega} \cdot t$ corresponds to generator $\sigma_\varphi = \sigma_A \hat{\varphi}_A + \sigma_B \hat{\varphi}_B + \sigma_C \hat{\varphi}_C$ of rotation $e^{-i\sigma_\varphi \varphi} = R(\vec{\varphi}) = \mathbf{1} \cos \varphi - i \sigma_\varphi \sin \varphi$ about axis $\vec{\varphi}$.

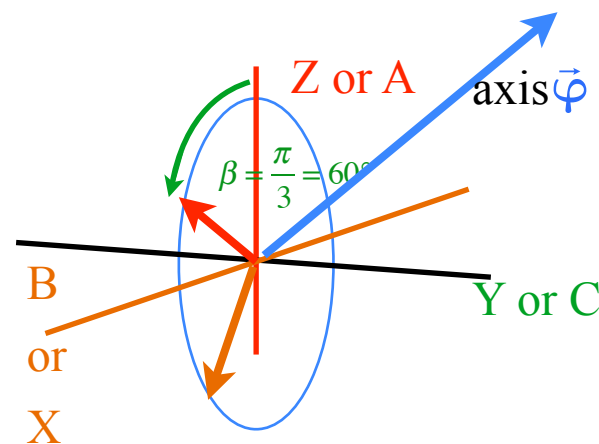

OBJECTIVE: Evaluate and (*most important!*) *visualize* matrix-exponent solutions.

ABCD Time evolution operator

$$|\Psi(t)\rangle = e^{-i\mathbf{H}\cdot t} |\Psi(0)\rangle$$

Hamilton generalized Euler's expansion $e^{-i\Omega t} = \cos \Omega t - i \sin \Omega t$ so matrix exponential becomes powerful.

$$e^{-i\mathbf{H}\cdot t} = e^{-i \begin{pmatrix} A & B-iC \\ B+iC & D \end{pmatrix} \cdot t} = e^{-i \frac{A-D}{2} \begin{pmatrix} 1 & 0 \\ 0 & -1 \end{pmatrix} \cdot t} e^{-iB \begin{pmatrix} 0 & 1 \\ 1 & 0 \end{pmatrix} \cdot t} e^{-iC \begin{pmatrix} 0 & -i \\ i & 0 \end{pmatrix} \cdot t} e^{-i \frac{A+D}{2} \begin{pmatrix} 1 & 0 \\ 0 & 1 \end{pmatrix} \cdot t} = e^{-i(\omega_0 \sigma_0 + \vec{\omega} \cdot \vec{\sigma}) \cdot t} = e^{-i\omega_0 t} (\mathbf{1} \cos \omega t - i \sigma_\varphi \sin \omega t)$$

$\sigma_A = \sigma_Z$ $\sigma_B = \sigma_X$ $\sigma_C = \sigma_Y$

$$e^{-i\varphi} = \mathbf{1} \cos \varphi - i \sin \varphi$$

generalizes to:

$$e^{-i\sigma_\varphi \varphi} = \mathbf{1} \cos \varphi - i \sigma_\varphi \sin \varphi$$

where: $\vec{\varphi} = \begin{pmatrix} \varphi_A \\ \varphi_B \\ \varphi_C \end{pmatrix} = \vec{\omega} \cdot t = \begin{pmatrix} \omega_A \\ \omega_B \\ \omega_C \end{pmatrix} \cdot t = \begin{pmatrix} \frac{A-D}{2} \\ B \\ C \end{pmatrix} \cdot t$ and: $\omega_0 = \frac{A+D}{2}$

$$e^{-i \begin{pmatrix} 1 & 0 \\ 0 & -1 \end{pmatrix} \varphi_A} = \begin{pmatrix} 1 & 0 \\ 0 & 1 \end{pmatrix} \cos \varphi_A - i \begin{pmatrix} 1 & 0 \\ 0 & -1 \end{pmatrix} \sin \varphi_A$$

$$= \begin{pmatrix} \cos \varphi_A & -i \sin \varphi_A & 0 \\ 0 & \cos \varphi_A & -i \sin \varphi_A \end{pmatrix} = \begin{pmatrix} e^{-i\varphi_A} & 0 \\ 0 & e^{i\varphi_A} \end{pmatrix}$$

Example 1:
A or Z
rotation

$$e^{-i \begin{pmatrix} 0 & -i \\ i & 0 \end{pmatrix} \varphi_C} = \begin{pmatrix} 1 & 0 \\ 0 & 1 \end{pmatrix} \cos \varphi_C - i \begin{pmatrix} 0 & -i \\ i & 0 \end{pmatrix} \sin \varphi_C$$

$$= \begin{pmatrix} \cos \varphi_C & -\sin \varphi_C \\ \sin \varphi_C & \cos \varphi_C \end{pmatrix}$$

Example 2:
C or Y
rotation

3D axis vector $\vec{\varphi} = \vec{\omega} \cdot t$ corresponds to generator $\sigma_\varphi = \sigma_A \hat{\varphi}_A + \sigma_B \hat{\varphi}_B + \sigma_C \hat{\varphi}_C$ of rotation $e^{-i\sigma_\varphi \varphi} = R(\vec{\varphi}) = \mathbf{1} \cos \varphi - i \sigma_\varphi \sin \varphi$ about axis $\vec{\varphi}$.

Any 2-by-2 σ_μ -matrix may be rotated by any $R(\vec{\varphi})$ matrix acting *twice* (fore-and-aft⁻¹) to give: $\sigma_\mu^{(\vec{\varphi}\text{-rotated})} = R(\vec{\varphi}) \sigma_\mu R^{-1}(\vec{\varphi}) = R(\vec{\varphi}) \sigma_\mu R^\dagger(\vec{\varphi})$

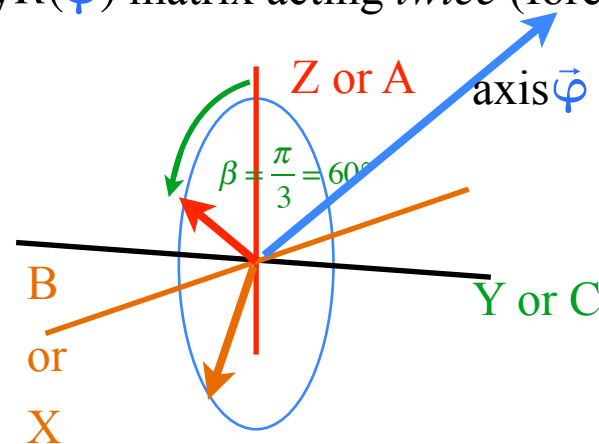

OBJECTIVE: Evaluate and (*most important!*) *visualize* matrix-exponent solutions.

ABCD Time evolution operator

$$|\Psi(t)\rangle = e^{-i\mathbf{H}\cdot t} |\Psi(0)\rangle$$

Hamilton generalized Euler's expansion $e^{-i\Omega t} = \cos \Omega t - i \sin \Omega t$ so matrix exponential becomes powerful.

$$e^{-i\mathbf{H}\cdot t} = e^{-i \begin{pmatrix} A & B-iC \\ B+iC & D \end{pmatrix} \cdot t} = e^{-i \frac{A-D}{2} \begin{pmatrix} 1 & 0 \\ 0 & -1 \end{pmatrix} \cdot t} e^{-iB \begin{pmatrix} 0 & 1 \\ 1 & 0 \end{pmatrix} \cdot t} e^{-iC \begin{pmatrix} 0 & -i \\ i & 0 \end{pmatrix} \cdot t} e^{-i \frac{A+D}{2} \begin{pmatrix} 1 & 0 \\ 0 & 1 \end{pmatrix} \cdot t} = e^{-i(\omega_0 \sigma_0 + \vec{\omega} \cdot \vec{\sigma}) \cdot t} = e^{-i\omega_0 t} (\mathbf{1} \cos \omega t - i \sigma_\varphi \sin \omega t)$$

$\sigma_A = \sigma_Z$ $\sigma_B = \sigma_X$ $\sigma_C = \sigma_Y$

$$e^{-i\varphi} = \mathbf{1} \cos \varphi - i \sin \varphi$$

generalizes to:

$$e^{-i\sigma_\varphi \varphi} = \mathbf{1} \cos \varphi - i \sigma_\varphi \sin \varphi$$

where: $\vec{\varphi} = \begin{pmatrix} \varphi_A \\ \varphi_B \\ \varphi_C \end{pmatrix} = \vec{\omega} \cdot t = \begin{pmatrix} \omega_A \\ \omega_B \\ \omega_C \end{pmatrix} \cdot t = \begin{pmatrix} \frac{A-D}{2} \\ B \\ C \end{pmatrix} \cdot t$ and: $\omega_0 = \frac{A+D}{2}$

$$e^{-i \begin{pmatrix} 1 & 0 \\ 0 & -1 \end{pmatrix} \varphi_A} = \begin{pmatrix} 1 & 0 \\ 0 & 1 \end{pmatrix} \cos \varphi_A - i \begin{pmatrix} 1 & 0 \\ 0 & -1 \end{pmatrix} \sin \varphi_A$$

$$= \begin{pmatrix} \cos \varphi_A & -i \sin \varphi_A & 0 \\ 0 & \cos \varphi_A & -i \sin \varphi_A \end{pmatrix} = \begin{pmatrix} e^{-i\varphi_A} & 0 \\ 0 & e^{i\varphi_A} \end{pmatrix}$$

Example 1:
A or Z
rotation

$$e^{-i \begin{pmatrix} 0 & -i \\ i & 0 \end{pmatrix} \varphi_C} = \begin{pmatrix} 1 & 0 \\ 0 & 1 \end{pmatrix} \cos \varphi_C - i \begin{pmatrix} 0 & -i \\ i & 0 \end{pmatrix} \sin \varphi_C$$

$$= \begin{pmatrix} \cos \varphi_C & -\sin \varphi_C \\ \sin \varphi_C & \cos \varphi_C \end{pmatrix}$$

Example 2:
C or Y
rotation

3D axis vector $\vec{\varphi} = \vec{\omega} \cdot t$ corresponds to generator $\sigma_\varphi = \sigma_A \hat{\varphi}_A + \sigma_B \hat{\varphi}_B + \sigma_C \hat{\varphi}_C$ of rotation $e^{-i\sigma_\varphi \varphi} = R(\vec{\varphi}) = \mathbf{1} \cos \varphi - i \sigma_\varphi \sin \varphi$ about axis $\vec{\varphi}$.

Any 2-by-2 σ_μ -matrix may be rotated by any $R(\vec{\varphi})$ matrix acting *twice* (fore-and-aft⁻¹) to give: $\sigma_\mu^{(\vec{\varphi}\text{-rotated})} = R(\vec{\varphi}) \sigma_\mu R^{-1}(\vec{\varphi}) = R(\vec{\varphi}) \sigma_\mu R^\dagger(\vec{\varphi})$

$$\mathbf{R}(\varphi_C) \cdot \sigma_A \cdot \mathbf{R}^{-1}(\varphi_C)$$

$$= \begin{pmatrix} \cos \varphi_C & -\sin \varphi_C \\ \sin \varphi_C & \cos \varphi_C \end{pmatrix} \begin{pmatrix} 1 & 0 \\ 0 & -1 \end{pmatrix} \begin{pmatrix} \cos \varphi_C & \sin \varphi_C \\ -\sin \varphi_C & \cos \varphi_C \end{pmatrix}$$

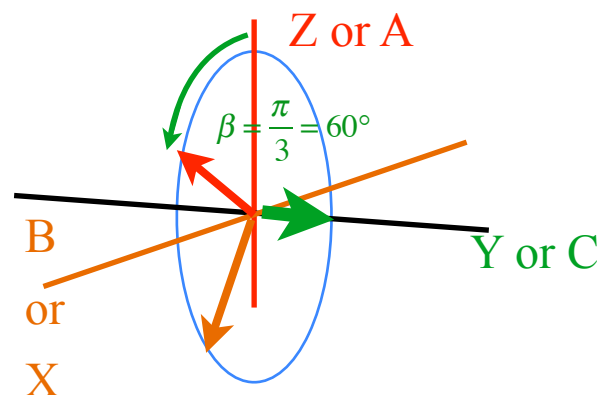

OBJECTIVE: Evaluate and (*most important!*) *visualize* matrix-exponent solutions.

ABCD Time evolution operator

$$|\Psi(t)\rangle = e^{-i\mathbf{H}\cdot t} |\Psi(0)\rangle$$

Hamilton generalized Euler's expansion $e^{-i\Omega t} = \cos \Omega t - i \sin \Omega t$ so matrix exponential becomes powerful.

$$e^{-i\mathbf{H}\cdot t} = e^{-i \begin{pmatrix} A & B-iC \\ B+iC & D \end{pmatrix} \cdot t} = e^{-i \frac{A-D}{2} \begin{pmatrix} 1 & 0 \\ 0 & -1 \end{pmatrix} \cdot t} e^{-iB \begin{pmatrix} 0 & 1 \\ 1 & 0 \end{pmatrix} \cdot t} e^{-iC \begin{pmatrix} 0 & -i \\ i & 0 \end{pmatrix} \cdot t} e^{-i \frac{A+D}{2} \begin{pmatrix} 1 & 0 \\ 0 & 1 \end{pmatrix} \cdot t} = e^{-i(\omega_0 \sigma_0 + \vec{\omega} \cdot \vec{\sigma}) \cdot t} = e^{-i\omega_0 t} (\mathbf{1} \cos \omega t - i \sigma_\varphi \sin \omega t)$$

$\sigma_A = \sigma_Z$ $\sigma_B = \sigma_X$ $\sigma_C = \sigma_Y$

$$e^{-i\varphi} = \mathbf{1} \cos \varphi - i \sin \varphi$$

generalizes to:

$$e^{-i\sigma_\varphi \varphi} = \mathbf{1} \cos \varphi - i \sigma_\varphi \sin \varphi$$

where: $\vec{\varphi} = \begin{pmatrix} \varphi_A \\ \varphi_B \\ \varphi_C \end{pmatrix} = \vec{\omega} \cdot t = \begin{pmatrix} \omega_A \\ \omega_B \\ \omega_C \end{pmatrix} \cdot t = \begin{pmatrix} \frac{A-D}{2} \\ B \\ C \end{pmatrix} \cdot t$ and: $\omega_0 = \frac{A+D}{2}$

$$e^{-i \begin{pmatrix} 1 & 0 \\ 0 & -1 \end{pmatrix} \varphi_A} = \begin{pmatrix} 1 & 0 \\ 0 & 1 \end{pmatrix} \cos \varphi_A - i \begin{pmatrix} 1 & 0 \\ 0 & -1 \end{pmatrix} \sin \varphi_A$$

$$= \begin{pmatrix} \cos \varphi_A - i \sin \varphi_A & 0 \\ 0 & \cos \varphi_A + i \sin \varphi_A \end{pmatrix} = \begin{pmatrix} e^{-i\varphi_A} & 0 \\ 0 & e^{i\varphi_A} \end{pmatrix}$$

Example 1:
A or Z
rotation

$$e^{-i \begin{pmatrix} 0 & -i \\ i & 0 \end{pmatrix} \varphi_C} = \begin{pmatrix} 1 & 0 \\ 0 & 1 \end{pmatrix} \cos \varphi_C - i \begin{pmatrix} 0 & -i \\ i & 0 \end{pmatrix} \sin \varphi_C$$

$$= \begin{pmatrix} \cos \varphi_C & -\sin \varphi_C \\ \sin \varphi_C & \cos \varphi_C \end{pmatrix}$$

Example 2:
C or Y
rotation

3D axis vector $\vec{\varphi} = \vec{\omega} \cdot t$ corresponds to generator $\sigma_\varphi = \sigma_A \hat{\varphi}_A + \sigma_B \hat{\varphi}_B + \sigma_C \hat{\varphi}_C$ of rotation $e^{-i\sigma_\varphi \varphi} = R(\vec{\varphi}) = \mathbf{1} \cos \varphi - i \sigma_\varphi \sin \varphi$ about axis $\vec{\varphi}$.

Any 2-by-2 σ_μ -matrix may be rotated by any $R(\vec{\varphi})$ matrix acting *twice* (fore-and-aft⁻¹) to give: $\sigma_\mu^{(\vec{\varphi}\text{-rotated})} = R(\vec{\varphi}) \sigma_\mu R^{-1}(\vec{\varphi}) = R(\vec{\varphi}) \sigma_\mu R^\dagger(\vec{\varphi})$

$$\mathbf{R}(\varphi_C) \cdot \sigma_A \cdot \mathbf{R}^{-1}(\varphi_C)$$

$$= \begin{pmatrix} \cos \varphi_C & -\sin \varphi_C \\ \sin \varphi_C & \cos \varphi_C \end{pmatrix} \begin{pmatrix} 1 & 0 \\ 0 & -1 \end{pmatrix} \begin{pmatrix} \cos \varphi_C & \sin \varphi_C \\ -\sin \varphi_C & \cos \varphi_C \end{pmatrix}$$

$$= \begin{pmatrix} \cos^2 \varphi_C - \sin^2 \varphi_C & 2 \sin \varphi_C \cos \varphi_C \\ 2 \sin \varphi_C \cos \varphi_C & \sin^2 \varphi_C - \cos^2 \varphi_C \end{pmatrix}$$

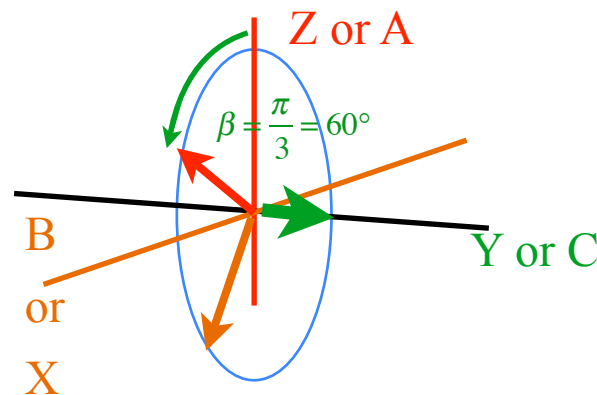

OBJECTIVE: Evaluate and (*most important!*) *visualize* matrix-exponent solutions.

ABCD Time evolution operator

$$|\Psi(t)\rangle = e^{-i\mathbf{H}\cdot t} |\Psi(0)\rangle$$

Hamilton generalized Euler's expansion $e^{-i\Omega t} = \cos \Omega t - i \sin \Omega t$ so matrix exponential becomes powerful.

$$e^{-i\mathbf{H}\cdot t} = e^{-i \begin{pmatrix} A & B-iC \\ B+iC & D \end{pmatrix} \cdot t} = e^{-i \frac{A-D}{2} \begin{pmatrix} 1 & 0 \\ 0 & -1 \end{pmatrix} \cdot t} e^{-iB \begin{pmatrix} 0 & 1 \\ 1 & 0 \end{pmatrix} \cdot t} e^{-iC \begin{pmatrix} 0 & -i \\ i & 0 \end{pmatrix} \cdot t} e^{-i \frac{A+D}{2} \begin{pmatrix} 1 & 0 \\ 0 & 1 \end{pmatrix} \cdot t} = e^{-i(\omega_0 \sigma_0 + \vec{\omega} \cdot \vec{\sigma}) \cdot t} = e^{-i\omega_0 t} (\mathbf{1} \cos \omega t - i \sigma_\varphi \sin \omega t)$$

$\sigma_A = \sigma_Z$ $\sigma_B = \sigma_X$ $\sigma_C = \sigma_Y$

$$e^{-i\varphi} = \mathbf{1} \cos \varphi - i \sin \varphi$$

generalizes to:

$$e^{-i\sigma_\varphi \varphi} = \mathbf{1} \cos \varphi - i \sigma_\varphi \sin \varphi$$

where: $\vec{\varphi} = \begin{pmatrix} \varphi_A \\ \varphi_B \\ \varphi_C \end{pmatrix} = \vec{\omega} \cdot t = \begin{pmatrix} \omega_A \\ \omega_B \\ \omega_C \end{pmatrix} \cdot t = \begin{pmatrix} \frac{A-D}{2} \\ B \\ C \end{pmatrix} \cdot t$ and: $\omega_0 = \frac{A+D}{2}$

$$e^{-i \begin{pmatrix} 1 & 0 \\ 0 & -1 \end{pmatrix} \varphi_A} = \begin{pmatrix} 1 & 0 \\ 0 & 1 \end{pmatrix} \cos \varphi_A - i \begin{pmatrix} 1 & 0 \\ 0 & -1 \end{pmatrix} \sin \varphi_A$$

$$= \begin{pmatrix} \cos \varphi_A & -i \sin \varphi_A & 0 \\ 0 & \cos \varphi_A & -i \sin \varphi_A \end{pmatrix} = \begin{pmatrix} e^{-i\varphi_A} & 0 \\ 0 & e^{i\varphi_A} \end{pmatrix}$$

Example 1:
A or Z
rotation

$$e^{-i \begin{pmatrix} 0 & -i \\ i & 0 \end{pmatrix} \varphi_C} = \begin{pmatrix} 1 & 0 \\ 0 & 1 \end{pmatrix} \cos \varphi_C - i \begin{pmatrix} 0 & -i \\ i & 0 \end{pmatrix} \sin \varphi_C$$

$$= \begin{pmatrix} \cos \varphi_C & -\sin \varphi_C \\ \sin \varphi_C & \cos \varphi_C \end{pmatrix}$$

Example 2:
C or Y
rotation

3D axis vector $\vec{\varphi} = \vec{\omega} \cdot t$ corresponds to generator $\sigma_\varphi = \sigma_A \hat{\varphi}_A + \sigma_B \hat{\varphi}_B + \sigma_C \hat{\varphi}_C$ of rotation $e^{-i\sigma_\varphi \varphi} = R(\vec{\varphi}) = \mathbf{1} \cos \varphi - i \sigma_\varphi \sin \varphi$ about axis $\vec{\varphi}$.

Any 2-by-2 σ_μ -matrix may be rotated by any $R(\vec{\varphi})$ matrix acting *twice* (fore-and-aft⁻¹) to give: $\sigma_\mu^{(\vec{\varphi}\text{-rotated})} = R(\vec{\varphi}) \sigma_\mu R^{-1}(\vec{\varphi}) = R(\vec{\varphi}) \sigma_\mu R^\dagger(\vec{\varphi})$

$$R(\varphi_C) \cdot \sigma_A \cdot R^{-1}(\varphi_C)$$

$$= \begin{pmatrix} \cos \varphi_C & -\sin \varphi_C \\ \sin \varphi_C & \cos \varphi_C \end{pmatrix} \begin{pmatrix} 1 & 0 \\ 0 & -1 \end{pmatrix} \begin{pmatrix} \cos \varphi_C & \sin \varphi_C \\ -\sin \varphi_C & \cos \varphi_C \end{pmatrix}$$

$$= \begin{pmatrix} \cos^2 \varphi_C - \sin^2 \varphi_C & 2 \sin \varphi_C \cos \varphi_C \\ 2 \sin \varphi_C \cos \varphi_C & \sin^2 \varphi_C - \cos^2 \varphi_C \end{pmatrix}$$

$$= \begin{pmatrix} 1 & 0 \\ 0 & -1 \end{pmatrix} \cos 2\varphi_C + \begin{pmatrix} 0 & 1 \\ 1 & 0 \end{pmatrix} \sin 2\varphi_C$$

$$= \sigma_A \cos 2\varphi_C + \sigma_B \sin 2\varphi_C$$

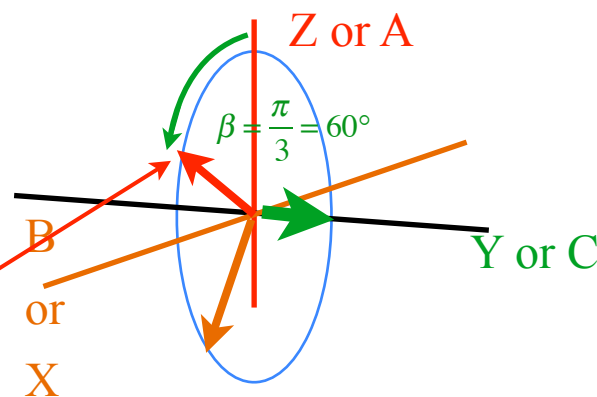

OBJECTIVE: Evaluate and (*most important!*) *visualize* matrix-exponent solutions.

ABCD Time evolution operator

$$|\Psi(t)\rangle = e^{-i\mathbf{H}\cdot t} |\Psi(0)\rangle$$

Hamilton generalized Euler's expansion $e^{-i\Omega t} = \cos \Omega t - i \sin \Omega t$ so matrix exponential becomes powerful.

$$e^{-i\mathbf{H}\cdot t} = e^{-i \begin{pmatrix} A & B-iC \\ B+iC & D \end{pmatrix} \cdot t} = e^{-i \frac{A-D}{2} \begin{pmatrix} 1 & 0 \\ 0 & -1 \end{pmatrix} \cdot t} e^{-iB \begin{pmatrix} 0 & 1 \\ 1 & 0 \end{pmatrix} \cdot t} e^{-iC \begin{pmatrix} 0 & -i \\ i & 0 \end{pmatrix} \cdot t} e^{-i \frac{A+D}{2} \begin{pmatrix} 1 & 0 \\ 0 & 1 \end{pmatrix} \cdot t} = e^{-i(\omega_0 \sigma_0 + \vec{\omega} \cdot \vec{\sigma}) \cdot t} = e^{-i\omega_0 t} \left(\mathbf{1} \cos \omega t - i \sigma_\varphi \sin \omega t \right)$$

$\sigma_A = \sigma_Z$ $\sigma_B = \sigma_X$ $\sigma_C = \sigma_Y$

$$e^{-i\varphi} = \mathbf{1} \cos \varphi - i \sin \varphi$$

generalizes to:

$$e^{-i\sigma_\varphi \varphi} = \mathbf{1} \cos \varphi - i \sigma_\varphi \sin \varphi$$

where: $\vec{\varphi} = \begin{pmatrix} \varphi_A \\ \varphi_B \\ \varphi_C \end{pmatrix} = \vec{\omega} \cdot t = \begin{pmatrix} \omega_A \\ \omega_B \\ \omega_C \end{pmatrix} \cdot t = \begin{pmatrix} \frac{A-D}{2} \\ B \\ C \end{pmatrix} \cdot t$ and: $\omega_0 = \frac{A+D}{2}$

$$e^{-i \begin{pmatrix} 1 & 0 \\ 0 & -1 \end{pmatrix} \varphi_A} = \begin{pmatrix} 1 & 0 \\ 0 & 1 \end{pmatrix} \cos \varphi_A - i \begin{pmatrix} 1 & 0 \\ 0 & -1 \end{pmatrix} \sin \varphi_A$$

$$= \begin{pmatrix} \cos \varphi_A & -i \sin \varphi_A & 0 \\ 0 & \cos \varphi_A & -i \sin \varphi_A \end{pmatrix} = \begin{pmatrix} e^{-i\varphi_A} & 0 \\ 0 & e^{i\varphi_A} \end{pmatrix}$$

Example 1:
A or Z
rotation

$$e^{-i \begin{pmatrix} 0 & -i \\ i & 0 \end{pmatrix} \varphi_C} = \begin{pmatrix} 1 & 0 \\ 0 & 1 \end{pmatrix} \cos \varphi_C - i \begin{pmatrix} 0 & -i \\ i & 0 \end{pmatrix} \sin \varphi_C$$

$$= \begin{pmatrix} \cos \varphi_C & -\sin \varphi_C \\ \sin \varphi_C & \cos \varphi_C \end{pmatrix}$$

Example 2:
C or Y
rotation

3D axis vector $\vec{\varphi} = \vec{\omega} \cdot t$ corresponds to generator $\sigma_\varphi = \sigma_A \hat{\varphi}_A + \sigma_B \hat{\varphi}_B + \sigma_C \hat{\varphi}_C$ of rotation $e^{-i\sigma_\varphi \varphi} = R(\vec{\varphi}) = \mathbf{1} \cos \varphi - i \sigma_\varphi \sin \varphi$ about axis $\vec{\varphi}$.

Any 2-by-2 σ_μ -matrix may be rotated by any $R(\vec{\varphi})$ matrix acting *twice* (fore-and-aft⁻¹) to give: $\sigma_\mu^{(\vec{\varphi}\text{-rotated})} = R(\vec{\varphi}) \sigma_\mu R^{-1}(\vec{\varphi}) = R(\vec{\varphi}) \sigma_\mu R^\dagger(\vec{\varphi})$

$$R(\varphi_C) \cdot \sigma_A \cdot R^{-1}(\varphi_C)$$

$$= \begin{pmatrix} \cos \varphi_C & -\sin \varphi_C \\ \sin \varphi_C & \cos \varphi_C \end{pmatrix} \begin{pmatrix} 1 & 0 \\ 0 & -1 \end{pmatrix} \begin{pmatrix} \cos \varphi_C & \sin \varphi_C \\ -\sin \varphi_C & \cos \varphi_C \end{pmatrix}$$

$$= \begin{pmatrix} \cos^2 \varphi_C - \sin^2 \varphi_C & 2 \sin \varphi_C \cos \varphi_C \\ 2 \sin \varphi_C \cos \varphi_C & \sin^2 \varphi_C - \cos^2 \varphi_C \end{pmatrix}$$

$$= \begin{pmatrix} 1 & 0 \\ 0 & -1 \end{pmatrix} \cos 2\varphi_C + \begin{pmatrix} 0 & 1 \\ 1 & 0 \end{pmatrix} \sin 2\varphi_C$$

$$= \sigma_A \cos 2\varphi_C + \sigma_B \sin 2\varphi_C$$

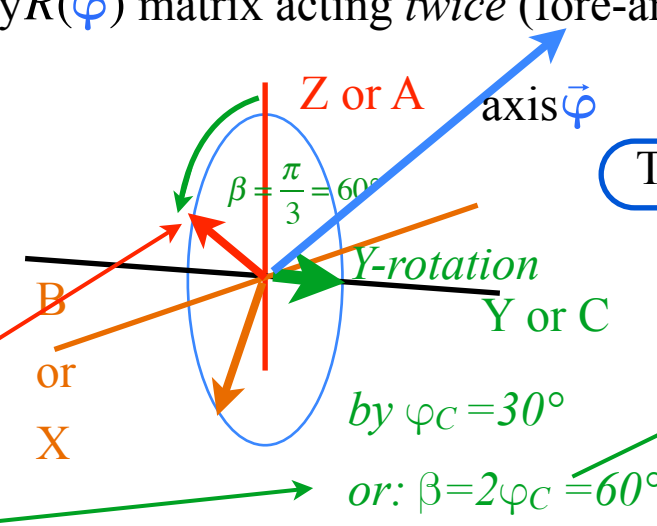

The 3D-rotation is by 2φ , *twice* the 2D angle φ .

OBJECTIVE: Evaluate and (*most important!*) *visualize* matrix-exponent solutions.

ABCD Time evolution operator

$$|\Psi(t)\rangle = e^{-i\mathbf{H}\cdot t} |\Psi(0)\rangle$$

Hamilton generalized Euler's expansion $e^{-i\Omega t} = \cos \Omega t - i \sin \Omega t$ so matrix exponential becomes powerful.

$$e^{-i\mathbf{H}\cdot t} = e^{-i \begin{pmatrix} A & B-iC \\ B+iC & D \end{pmatrix} \cdot t} = e^{-i \frac{A-D}{2} \begin{pmatrix} 1 & 0 \\ 0 & -1 \end{pmatrix} \cdot t - iB \begin{pmatrix} 0 & 1 \\ 1 & 0 \end{pmatrix} \cdot t - iC \begin{pmatrix} 0 & -i \\ i & 0 \end{pmatrix} \cdot t - i \frac{A+D}{2} \begin{pmatrix} 1 & 0 \\ 0 & 1 \end{pmatrix} \cdot t} = e^{-i(\omega_0 \sigma_0 + \vec{\omega} \cdot \vec{\sigma}) \cdot t} = e^{-i\omega_0 t} \left(\mathbf{1} \cos \omega t - i \sigma_\varphi \sin \omega t \right)$$

$\sigma_A = \sigma_Z$ $\sigma_B = \sigma_X$ $\sigma_C = \sigma_Y$

$$e^{-i\varphi} = \mathbf{1} \cos \varphi - i \sin \varphi$$

generalizes to:

$$e^{-i\sigma_\varphi \varphi} = \mathbf{1} \cos \varphi - i \sigma_\varphi \sin \varphi$$

where: $\vec{\varphi} = \begin{pmatrix} \varphi_A \\ \varphi_B \\ \varphi_C \end{pmatrix} = \vec{\omega} \cdot t = \begin{pmatrix} \omega_A \\ \omega_B \\ \omega_C \end{pmatrix} \cdot t = \begin{pmatrix} \frac{A-D}{2} \\ B \\ C \end{pmatrix} \cdot t$ and: $\omega_0 = \frac{A+D}{2}$

$$e^{-i \begin{pmatrix} 1 & 0 \\ 0 & -1 \end{pmatrix} \varphi_A} = \begin{pmatrix} 1 & 0 \\ 0 & 1 \end{pmatrix} \cos \varphi_A - i \begin{pmatrix} 1 & 0 \\ 0 & -1 \end{pmatrix} \sin \varphi_A$$

$$= \begin{pmatrix} \cos \varphi_A - i \sin \varphi_A & 0 \\ 0 & \cos \varphi_A - i \sin \varphi_A \end{pmatrix} = \begin{pmatrix} e^{-i\varphi_A} & 0 \\ 0 & e^{i\varphi_A} \end{pmatrix}$$

Example 1:
A or Z
rotation

$$e^{-i \begin{pmatrix} 0 & -i \\ i & 0 \end{pmatrix} \varphi_C} = \begin{pmatrix} 1 & 0 \\ 0 & 1 \end{pmatrix} \cos \varphi_C - i \begin{pmatrix} 0 & -i \\ i & 0 \end{pmatrix} \sin \varphi_C$$

$$= \begin{pmatrix} \cos \varphi_C & -\sin \varphi_C \\ \sin \varphi_C & \cos \varphi_C \end{pmatrix}$$

Example 2:
C or Y
rotation

3D axis vector $\vec{\varphi} = \vec{\omega} \cdot t$ corresponds to generator $\sigma_\varphi = \sigma_A \hat{\varphi}_A + \sigma_B \hat{\varphi}_B + \sigma_C \hat{\varphi}_C$ of rotation $e^{-i\sigma_\varphi \varphi} = R(\vec{\varphi}) = \mathbf{1} \cos \varphi - i \sigma_\varphi \sin \varphi$ about axis $\vec{\varphi}$.

Any 2-by-2 σ_μ -matrix may be rotated by any $R(\vec{\varphi})$ matrix acting *twice* (fore-and-aft⁻¹) to give: $\sigma_\mu^{(\vec{\varphi}\text{-rotated})} = R(\vec{\varphi}) \sigma_\mu R^{-1}(\vec{\varphi}) = R(\vec{\varphi}) \sigma_\mu R^\dagger(\vec{\varphi})$

$$R(\varphi_C) \cdot \sigma_A \cdot R^{-1}(\varphi_C)$$

$$= \begin{pmatrix} \cos \varphi_C & -\sin \varphi_C \\ \sin \varphi_C & \cos \varphi_C \end{pmatrix} \begin{pmatrix} 1 & 0 \\ 0 & -1 \end{pmatrix} \begin{pmatrix} \cos \varphi_C & \sin \varphi_C \\ -\sin \varphi_C & \cos \varphi_C \end{pmatrix}$$

$$= \begin{pmatrix} \cos^2 \varphi_C - \sin^2 \varphi_C & 2 \sin \varphi_C \cos \varphi_C \\ 2 \sin \varphi_C \cos \varphi_C & \sin^2 \varphi_C - \cos^2 \varphi_C \end{pmatrix}$$

$$= \begin{pmatrix} 1 & 0 \\ 0 & -1 \end{pmatrix} \cos 2\varphi_C + \begin{pmatrix} 0 & 1 \\ 1 & 0 \end{pmatrix} \sin 2\varphi_C$$

$$= \sigma_A \cos 2\varphi_C + \sigma_B \sin 2\varphi_C$$

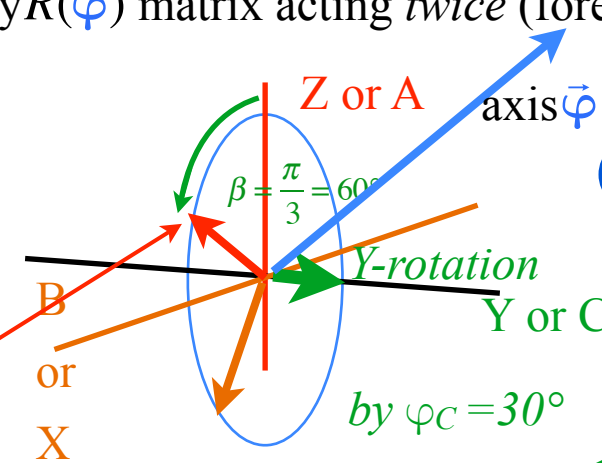

The 3D-rotation is by 2φ , *twice* the 2D angle φ .

$\vec{\varphi} = \vec{\omega} \cdot t$ equal to $\vec{\omega}$ only at $t=1$ but $\hat{\varphi} = \hat{\omega}$ always.

$$\hat{\varphi} = \begin{pmatrix} \hat{\varphi}_A \\ \hat{\varphi}_B \\ \hat{\varphi}_C \end{pmatrix} = \begin{pmatrix} \varphi_A \\ \varphi_B \\ \varphi_C \end{pmatrix} \frac{1}{\sqrt{\varphi_A^2 + \varphi_B^2 + \varphi_C^2}} = \begin{pmatrix} \omega_A \\ \omega_B \\ \omega_C \end{pmatrix} \frac{1}{\sqrt{\omega_A^2 + \omega_B^2 + \omega_C^2}}$$

OBJECTIVE: Evaluate and (*most important!*) *visualize* matrix-exponent solutions.

ABCD Time evolution operator

$$|\Psi(t)\rangle = e^{-i\mathbf{H}\cdot t} |\Psi(0)\rangle$$

Hamilton generalized Euler's expansion $e^{-i\Omega t} = \cos \Omega t - i \sin \Omega t$ so matrix exponential becomes powerful.

$$e^{-i\mathbf{H}\cdot t} = e^{-i \begin{pmatrix} A & B-iC \\ B+iC & D \end{pmatrix} \cdot t} = e^{-i \frac{A-D}{2} \begin{pmatrix} 1 & 0 \\ 0 & -1 \end{pmatrix} \cdot t} e^{-iB \begin{pmatrix} 0 & 1 \\ 1 & 0 \end{pmatrix} \cdot t} e^{-iC \begin{pmatrix} 0 & -i \\ i & 0 \end{pmatrix} \cdot t} e^{-i \frac{A+D}{2} \begin{pmatrix} 1 & 0 \\ 0 & 1 \end{pmatrix} \cdot t} = e^{-i(\omega_0 \sigma_0 + \vec{\omega} \cdot \vec{\sigma}) \cdot t} = e^{-i\omega_0 t} \left(\mathbf{1} \cos \omega t - i \sigma_\varphi \sin \omega t \right)$$

$\sigma_A = \sigma_Z$ $\sigma_B = \sigma_X$ $\sigma_C = \sigma_Y$

$$e^{-i\varphi} = \mathbf{1} \cos \varphi - i \sin \varphi$$

generalizes to:

$$e^{-i\sigma_\varphi \varphi} = \mathbf{1} \cos \varphi - i \sigma_\varphi \sin \varphi$$

where: $\vec{\varphi} = \begin{pmatrix} \varphi_A \\ \varphi_B \\ \varphi_C \end{pmatrix} = \vec{\omega} \cdot t = \begin{pmatrix} \omega_A \\ \omega_B \\ \omega_C \end{pmatrix} \cdot t = \begin{pmatrix} \frac{A-D}{2} \\ B \\ C \end{pmatrix} \cdot t$ and: $\omega_0 = \frac{A+D}{2}$

$$e^{-i \begin{pmatrix} 1 & 0 \\ 0 & -1 \end{pmatrix} \varphi_A} = \begin{pmatrix} 1 & 0 \\ 0 & 1 \end{pmatrix} \cos \varphi_A - i \begin{pmatrix} 1 & 0 \\ 0 & -1 \end{pmatrix} \sin \varphi_A$$

$$= \begin{pmatrix} \cos \varphi_A - i \sin \varphi_A & 0 \\ 0 & \cos \varphi_A - i \sin \varphi_A \end{pmatrix} = \begin{pmatrix} e^{-i\varphi_A} & 0 \\ 0 & e^{i\varphi_A} \end{pmatrix}$$

Example 1:
A or Z
rotation

$$e^{-i \begin{pmatrix} 0 & -i \\ i & 0 \end{pmatrix} \varphi_C} = \begin{pmatrix} 1 & 0 \\ 0 & 1 \end{pmatrix} \cos \varphi_C - i \begin{pmatrix} 0 & -i \\ i & 0 \end{pmatrix} \sin \varphi_C$$

$$= \begin{pmatrix} \cos \varphi_C & -\sin \varphi_C \\ \sin \varphi_C & \cos \varphi_C \end{pmatrix}$$

Example 2:
C or Y
rotation

3D axis vector $\vec{\varphi} = \vec{\omega} \cdot t$ corresponds to generator $\sigma_\varphi = \sigma_A \hat{\varphi}_A + \sigma_B \hat{\varphi}_B + \sigma_C \hat{\varphi}_C$ of rotation $e^{-i\sigma_\varphi \varphi} = R(\vec{\varphi}) = \mathbf{1} \cos \varphi - i \sigma_\varphi \sin \varphi$ about axis $\vec{\varphi}$.

Any 2-by-2 σ_μ -matrix may be rotated by any $R(\vec{\varphi})$ matrix acting *twice* (fore-and-aft⁻¹) to give: $\sigma_\mu^{(\vec{\varphi}\text{-rotated})} = R(\vec{\varphi}) \sigma_\mu R^{-1}(\vec{\varphi}) = R(\vec{\varphi}) \sigma_\mu R^\dagger(\vec{\varphi})$

$$R(\varphi_C) \cdot \sigma_A \cdot R^{-1}(\varphi_C)$$

$$= \begin{pmatrix} \cos \varphi_C & -\sin \varphi_C \\ \sin \varphi_C & \cos \varphi_C \end{pmatrix} \begin{pmatrix} 1 & 0 \\ 0 & -1 \end{pmatrix} \begin{pmatrix} \cos \varphi_C & \sin \varphi_C \\ -\sin \varphi_C & \cos \varphi_C \end{pmatrix}$$

$$= \begin{pmatrix} \cos^2 \varphi_C - \sin^2 \varphi_C & 2 \sin \varphi_C \cos \varphi_C \\ 2 \sin \varphi_C \cos \varphi_C & \sin^2 \varphi_C - \cos^2 \varphi_C \end{pmatrix}$$

$$= \begin{pmatrix} 1 & 0 \\ 0 & -1 \end{pmatrix} \cos 2\varphi_C + \begin{pmatrix} 0 & 1 \\ 1 & 0 \end{pmatrix} \sin 2\varphi_C$$

$$= \sigma_A \cos 2\varphi_C + \sigma_B \sin 2\varphi_C$$

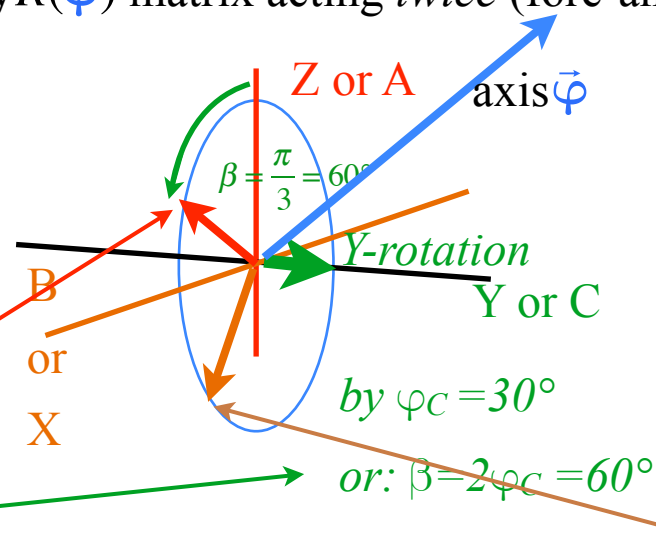

$$R(\varphi_C) \cdot \sigma_B \cdot R^{-1}(\varphi_C)$$

$$= \begin{pmatrix} \cos \varphi_C & -\sin \varphi_C \\ \sin \varphi_C & \cos \varphi_C \end{pmatrix} \begin{pmatrix} 0 & 1 \\ 1 & 0 \end{pmatrix} \begin{pmatrix} \cos \varphi_C & \sin \varphi_C \\ -\sin \varphi_C & \cos \varphi_C \end{pmatrix}$$

$$= \begin{pmatrix} -2 \sin \varphi_C \cos \varphi_C & \cos^2 \varphi_C - \sin^2 \varphi_C \\ \cos^2 \varphi_C - \sin^2 \varphi_C & 2 \sin \varphi_C \cos \varphi_C \end{pmatrix}$$

$$= \begin{pmatrix} -1 & 0 \\ 0 & 1 \end{pmatrix} \sin 2\varphi_C + \begin{pmatrix} 0 & 1 \\ 1 & 0 \end{pmatrix} \cos 2\varphi_C$$

$$= -\sigma_A \sin 2\varphi_C + \sigma_B \cos 2\varphi_C$$

The 3D-rotation is by 2φ , *twice* the 2D angle φ .

Review: How C_2 (Bilateral σ_B reflection) symmetry is eigen-solver

$U(2)$ vs $R(3)$: 2-State Schrodinger: $i\hbar\partial_t|\Psi(t)\rangle = \mathbf{H}|\Psi(t)\rangle$ vs. Classical 2D-HO: $\partial_t^2\mathbf{x} = -\mathbf{K}\cdot\mathbf{x}$

Hamilton-Pauli spinor symmetry (σ -expansion in $ABCD$ -Types) $\mathbf{H} = \omega_\mu \sigma_\mu$

Deriving σ -exponential time evolution (or revolution) operator $\mathbf{U} = e^{-i\mathbf{H}t} = e^{-i\sigma_\mu \omega_\mu t}$

Spinor arithmetic like complex arithmetic

Spinor vector algebra like complex vector algebra

Spinor exponentials like complex exponentials ("Crazy-Thing"-Theorem)

 Geometry of $U(2)$ evolution (or $R(3)$ revolution) operator $\mathbf{U} = e^{-i\mathbf{H}t} = e^{-i\sigma_\mu \omega_\mu t}$

 The "mysterious" factors of 2 (or 1/2): 2D Spinor vs 3D Spin Vector space

2D Spinor vs 3D vector rotation

NMR Hamiltonian: 3D Spin Moment \mathbf{m} in \mathbf{B} field

Euler's state definition using rotations $\mathbf{R}(\alpha, 0, 0)$, $\mathbf{R}(0, \beta, 0)$, and $\mathbf{R}(0, 0, \gamma)$

Spin-1 (3D-real vector) case

Spin-1/2 (2D-complex spinor) case

3D-real Stokes Vector defines 2D-HO polarization ellipses and spinor states

Asymmetry $S_A = S_Z$, Balance $S_B = S_X$, and Chirality $S_C = S_Y$

Polarization ellipse and spinor state dynamics

The "mysterious" factors of 2 (or 1/2): 2D Spinor vs 3D Spin Vector space

$$\mathbf{H} = \begin{pmatrix} A & B - iC \\ B + iC & D \end{pmatrix} = \frac{A+D}{2} \begin{pmatrix} 1 & 0 \\ 0 & 1 \end{pmatrix} + \frac{A-D}{2} \begin{pmatrix} 1 & 0 \\ 0 & -1 \end{pmatrix} + B \begin{pmatrix} 0 & 1 \\ 1 & 0 \end{pmatrix} + C \begin{pmatrix} 0 & -i \\ i & 0 \end{pmatrix}$$

Notation for
2D Spinor space

$$= \omega_0 \sigma_0 + \omega_A \sigma_A + \omega_B \sigma_B + \omega_C \sigma_C = \omega_0 \sigma_0 + \vec{\omega} \cdot \vec{\sigma} = \omega_0 \mathbf{1} + \omega \sigma_\omega$$

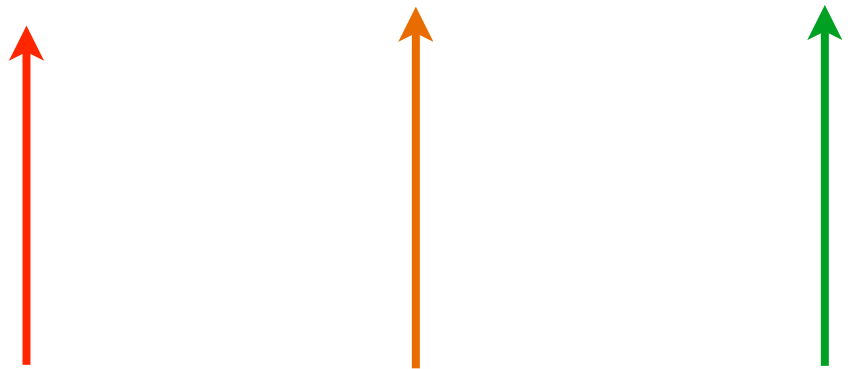

Symmetry archetypes: *A (Asymmetric-diagonal) | B (Bilateral-balanced) | C (Chiral-circular-complex...)*

The { $\sigma_I, \sigma_A, \sigma_B, \sigma_C$ } are the well known *Pauli-spin operators* { $\sigma_I = \sigma_0, \sigma_B = \sigma_X, \sigma_C = \sigma_Y, \sigma_A = \sigma_Z$ }

The "mysterious" factors of 2 (or 1/2): 2D Spinor vs 3D Spin Vector space

$$\begin{aligned}
 \mathbf{H} &= \begin{pmatrix} A & B-iC \\ B+iC & D \end{pmatrix} = \frac{A+D}{2} \begin{pmatrix} 1 & 0 \\ 0 & 1 \end{pmatrix} + \frac{A-D}{2} \begin{pmatrix} 1 & 0 \\ 0 & -1 \end{pmatrix} + B \begin{pmatrix} 0 & 1 \\ 1 & 0 \end{pmatrix} + C \begin{pmatrix} 0 & -i \\ i & 0 \end{pmatrix} && \text{Notation for} \\
 & && \text{2D Spinor space} \\
 &= \omega_0 \sigma_0 + \omega_A \sigma_A + \omega_B \sigma_B + \omega_C \sigma_C = \omega_0 \sigma_0 + \vec{\omega} \cdot \vec{\sigma} = \omega_0 \mathbf{1} + \omega \sigma_\omega \\
 &= \Omega_0 \mathbf{1} + \Omega_A \mathbf{S}_A + \Omega_B \mathbf{S}_B + \Omega_C \mathbf{S}_C = \Omega_0 \mathbf{1} + \vec{\Omega} \cdot \vec{\mathbf{S}} \\
 &= \frac{A+D}{2} \begin{pmatrix} 1 & 0 \\ 0 & 1 \end{pmatrix} + (A-D) \begin{pmatrix} \frac{1}{2} & 0 \\ 0 & -\frac{1}{2} \end{pmatrix} + 2B \begin{pmatrix} 0 & \frac{1}{2} \\ \frac{1}{2} & 0 \end{pmatrix} + 2C \begin{pmatrix} 0 & -\frac{i}{2} \\ \frac{i}{2} & 0 \end{pmatrix} && \text{Notation for} \\
 & && \text{3D Vector space} \\
 & \text{0}^{\text{th}} \text{ component} && \text{components } A, B, C \text{ switch } 1/2\text{-factor from } \omega\text{-velocity to } S\text{-momentum}
 \end{aligned}$$

Symmetry archetypes: *A* (Asymmetric-diagonal) | *B* (Bilateral-balanced) | *C* (Chiral-circular-complex...)

The { $\sigma_I, \sigma_A, \sigma_B, \sigma_C$ } are the well known *Pauli-spin operators* { $\sigma_I = \sigma_0, \sigma_B = \sigma_X, \sigma_C = \sigma_Y, \sigma_A = \sigma_Z$ }

The "mysterious" factors of 2 (or 1/2): 2D Spinor vs 3D Spin Vector space

$$\begin{aligned}
 \mathbf{H} &= \begin{pmatrix} A & B-iC \\ B+iC & D \end{pmatrix} = \frac{A+D}{2} \begin{pmatrix} 1 & 0 \\ 0 & 1 \end{pmatrix} + \frac{A-D}{2} \begin{pmatrix} 1 & 0 \\ 0 & -1 \end{pmatrix} + B \begin{pmatrix} 0 & 1 \\ 1 & 0 \end{pmatrix} + C \begin{pmatrix} 0 & -i \\ i & 0 \end{pmatrix} && \text{Notation for} \\
 & && \text{2D Spinor space} \\
 &= \omega_0 \sigma_0 + \omega_A \sigma_A + \omega_B \sigma_B + \omega_C \sigma_C = \omega_0 \sigma_0 + \vec{\omega} \cdot \vec{\sigma} = \omega_0 \mathbf{1} + \omega \sigma_\omega \\
 &= \Omega_0 \mathbf{1} + \Omega_A \mathbf{S}_A + \Omega_B \mathbf{S}_B + \Omega_C \mathbf{S}_C = \Omega_0 \mathbf{1} + \vec{\Omega} \cdot \vec{\mathbf{S}} \\
 &= \frac{A+D}{2} \begin{pmatrix} 1 & 0 \\ 0 & 1 \end{pmatrix} + (A-D) \begin{pmatrix} \frac{1}{2} & 0 \\ 0 & -\frac{1}{2} \end{pmatrix} + 2B \begin{pmatrix} 0 & \frac{1}{2} \\ \frac{1}{2} & 0 \end{pmatrix} + 2C \begin{pmatrix} 0 & -\frac{i}{2} \\ \frac{i}{2} & 0 \end{pmatrix} && \text{Notation for} \\
 & && \text{3D Vector space} \\
 & \text{0}^{\text{th}} \text{ component} && \text{components } A, B, C \text{ switch } 1/2\text{-factor from } \omega\text{-velocity to } S\text{-momentum}
 \end{aligned}$$

Symmetry archetypes: *A* (Asymmetric-diagonal) | *B* (Bilateral-balanced) | *C* (Chiral-circular-complex...)

The { $\sigma_I, \sigma_A, \sigma_B, \sigma_C$ } are the well known *Pauli-spin operators* { $\sigma_I = \sigma_0, \sigma_B = \sigma_X, \sigma_C = \sigma_Y, \sigma_A = \sigma_Z$ }

The { $\mathbf{1}, \mathbf{S}_A, \mathbf{S}_B, \mathbf{S}_C$ } are the *Jordan-Angular-Momentum operators* { $\mathbf{1} = \sigma_0, \mathbf{S}_B = \mathbf{S}_X, \mathbf{S}_C = \mathbf{S}_Y, \mathbf{S}_A = \mathbf{S}_Z$ }
 (Often labeled { $\mathbf{J}_X, \mathbf{J}_Y, \mathbf{J}_Z$ })

The "mysterious" factors of 2 (or 1/2): 2D Spinor vs 3D Spin Vector space

$$\begin{aligned}
 \mathbf{H} &= \begin{pmatrix} A & B-iC \\ B+iC & D \end{pmatrix} = \frac{A+D}{2} \begin{pmatrix} 1 & 0 \\ 0 & 1 \end{pmatrix} + \frac{A-D}{2} \begin{pmatrix} 1 & 0 \\ 0 & -1 \end{pmatrix} + B \begin{pmatrix} 0 & 1 \\ 1 & 0 \end{pmatrix} + C \begin{pmatrix} 0 & -i \\ i & 0 \end{pmatrix} && \text{Notation for 2D Spinor space} \\
 &= \omega_0 \sigma_0 + \omega_A \sigma_A + \omega_B \sigma_B + \omega_C \sigma_C = \omega_0 \sigma_0 + \vec{\omega} \cdot \vec{\sigma} = \omega_0 \mathbf{1} + \omega \sigma_\omega \\
 &= \Omega_0 \mathbf{1} + \Omega_A \mathbf{S}_A + \Omega_B \mathbf{S}_B + \Omega_C \mathbf{S}_C = \Omega_0 \mathbf{1} + \vec{\Omega} \cdot \vec{\mathbf{S}} \\
 &= \frac{A+D}{2} \begin{pmatrix} 1 & 0 \\ 0 & 1 \end{pmatrix} + (A-D) \begin{pmatrix} \frac{1}{2} & 0 \\ 0 & -\frac{1}{2} \end{pmatrix} + 2B \begin{pmatrix} 0 & \frac{1}{2} \\ \frac{1}{2} & 0 \end{pmatrix} + 2C \begin{pmatrix} 0 & -\frac{i}{2} \\ \frac{i}{2} & 0 \end{pmatrix} && \text{Notation for 3D Vector space} \\
 &\quad \text{0}^{\text{th}} \text{ component unchanged} \quad \text{components } A, B, C \text{ switch } 1/2\text{-factor from } \omega\text{-velocity to } S\text{-momentum}
 \end{aligned}$$

Symmetry archetypes: *A* (Asymmetric-diagonal) | *B* (Bilateral-balanced) | *C* (Chiral-circular-complex...)

The { $\sigma_I, \sigma_A, \sigma_B, \sigma_C$ } are the well known *Pauli-spin operators* { $\sigma_I = \sigma_0, \sigma_B = \sigma_X, \sigma_C = \sigma_Y, \sigma_A = \sigma_Z$ }

The { $\mathbf{1}, \mathbf{S}_A, \mathbf{S}_B, \mathbf{S}_C$ } are the *Jordan-Angular-Momentum operators* { $\mathbf{1} = \sigma_0, \mathbf{S}_B = \mathbf{S}_X, \mathbf{S}_C = \mathbf{S}_Y, \mathbf{S}_A = \mathbf{S}_Z$ }
 (Often labeled { $\mathbf{J}_X, \mathbf{J}_Y, \mathbf{J}_Z$ })

Notation for 2D Spinor space

where: $\vec{\phi} = \vec{\omega} \cdot t = \begin{pmatrix} \omega_A \\ \omega_B \\ \omega_C \end{pmatrix} \cdot t = \begin{pmatrix} \frac{A-D}{2} \\ B \\ C \end{pmatrix} \cdot t$ and: $\omega_0 = \frac{A+D}{2}$

$$e^{-i\mathbf{H}t} = e^{-i \begin{pmatrix} A & B-iC \\ B+iC & D \end{pmatrix} t} = e^{-i(\omega_0 \sigma_0 + \vec{\omega} \cdot \vec{\sigma})t} = e^{-i\omega_0 t} e^{-i \vec{\omega} \cdot \vec{\sigma} t} = e^{-i\omega_0 t} e^{-i \sigma_\omega \omega t} = e^{-i\omega_0 t} (\mathbf{1} \cos \omega t - i \sigma_\omega \sin \omega t)$$

The "mysterious" factors of 2 (or 1/2): 2D Spinor vs 3D Spin Vector space

$$\begin{aligned}
 \mathbf{H} &= \begin{pmatrix} A & B-iC \\ B+iC & D \end{pmatrix} = \frac{A+D}{2} \begin{pmatrix} 1 & 0 \\ 0 & 1 \end{pmatrix} + \frac{A-D}{2} \begin{pmatrix} 1 & 0 \\ 0 & -1 \end{pmatrix} + B \begin{pmatrix} 0 & 1 \\ 1 & 0 \end{pmatrix} + C \begin{pmatrix} 0 & -i \\ i & 0 \end{pmatrix} && \text{Notation for 2D Spinor space} \\
 &= \omega_0 \sigma_0 + \omega_A \sigma_A + \omega_B \sigma_B + \omega_C \sigma_C = \omega_0 \sigma_0 + \vec{\omega} \cdot \vec{\sigma} = \omega_0 \mathbf{1} + \omega \sigma_\omega \\
 &= \Omega_0 \mathbf{1} + \Omega_A \mathbf{S}_A + \Omega_B \mathbf{S}_B + \Omega_C \mathbf{S}_C = \Omega_0 \mathbf{1} + \vec{\Omega} \cdot \vec{\mathbf{S}} \\
 &= \frac{A+D}{2} \begin{pmatrix} 1 & 0 \\ 0 & 1 \end{pmatrix} + (A-D) \begin{pmatrix} \frac{1}{2} & 0 \\ 0 & -\frac{1}{2} \end{pmatrix} + 2B \begin{pmatrix} 0 & \frac{1}{2} \\ \frac{1}{2} & 0 \end{pmatrix} + 2C \begin{pmatrix} 0 & -\frac{i}{2} \\ \frac{i}{2} & 0 \end{pmatrix} && \text{Notation for 3D Vector space} \\
 &\quad \text{\small } 0^{\text{th}} \text{ component unchanged} \quad \text{\small components } A, B, C \text{ switch } 1/2\text{-factor from } \omega\text{-velocity to } S\text{-momentum}
 \end{aligned}$$

Symmetry archetypes: A (Asymmetric[↑]diagonal) | B (Bilateral[↑]balanced) | C (Chiral[↑]circular-complex...)

The $\{\sigma_0, \sigma_A, \sigma_B, \sigma_C\}$ are the well known *Pauli-spin operators* $\{\sigma_0 = \sigma_0, \sigma_B = \sigma_X, \sigma_C = \sigma_Y, \sigma_A = \sigma_Z\}$

The $\{\mathbf{1}, \mathbf{S}_A, \mathbf{S}_B, \mathbf{S}_C\}$ are the *Jordan-Angular-Momentum operators* $\{\mathbf{1} = \sigma_0, \mathbf{S}_B = \mathbf{S}_X, \mathbf{S}_C = \mathbf{S}_Y, \mathbf{S}_A = \mathbf{S}_Z\}$
 (Often labeled $\{J_X, J_Y, J_Z\}$)

Notation for 2D Spinor space

where: $\vec{\phi} = \vec{\omega} \cdot t = \begin{pmatrix} \omega_A \\ \omega_B \\ \omega_C \end{pmatrix} \cdot t = \begin{pmatrix} \frac{A-D}{2} \\ B \\ C \end{pmatrix} \cdot t$ and: $\omega_0 = \frac{A+D}{2}$

$$\begin{aligned}
 e^{-i\mathbf{H} \cdot t} &= e^{-i \begin{pmatrix} A & B-iC \\ B+iC & D \end{pmatrix} \cdot t} = e^{-i(\omega_0 \sigma_0 + \vec{\omega} \cdot \vec{\sigma}) \cdot t} = e^{-i\omega_0 t} e^{-i \vec{\omega} \cdot \vec{\sigma} t} = e^{-i\omega_0 t} e^{-i \sigma_\omega \omega t} = e^{-i\omega_0 t} (\mathbf{1} \cos \omega t - i \sigma_\omega \sin \omega t) \\
 &= e^{-i(\Omega_0 \mathbf{1} + \vec{\Omega} \cdot \vec{\mathbf{S}}) \cdot t} = e^{-i\Omega_0 t} e^{-i \vec{\Omega} \cdot \vec{\mathbf{S}} t} = e^{-i\Omega_0 t} \left(\mathbf{1} \cos \frac{\Omega t}{2} - i \sigma_\omega \sin \frac{\Omega t}{2} \right)
 \end{aligned}$$

Notation for 3D Vector space

where: $\vec{\Theta} = \vec{\Omega} \cdot t = \begin{pmatrix} \Omega_A \\ \Omega_B \\ \Omega_C \end{pmatrix} \cdot t = \begin{pmatrix} A-D \\ 2B \\ 2C \end{pmatrix} \cdot t$ and: $\Omega_0 = \frac{A+D}{2}$

The "mysterious" factors of 2 (or 1/2): 2D Spinor vs 3D Spin Vector space

$$\begin{aligned}
 \mathbf{H} &= \begin{pmatrix} A & B-iC \\ B+iC & D \end{pmatrix} = \frac{A+D}{2} \begin{pmatrix} 1 & 0 \\ 0 & 1 \end{pmatrix} + \frac{A-D}{2} \begin{pmatrix} 1 & 0 \\ 0 & -1 \end{pmatrix} + B \begin{pmatrix} 0 & 1 \\ 1 & 0 \end{pmatrix} + C \begin{pmatrix} 0 & -i \\ i & 0 \end{pmatrix} && \text{Notation for 2D Spinor space} \\
 &= \omega_0 \sigma_0 + \omega_A \sigma_A + \omega_B \sigma_B + \omega_C \sigma_C = \omega_0 \sigma_0 + \vec{\omega} \cdot \vec{\sigma} = \omega_0 \mathbf{1} + \omega \sigma_\omega \\
 &= \Omega_0 \mathbf{1} + \Omega_A \mathbf{S}_A + \Omega_B \mathbf{S}_B + \Omega_C \mathbf{S}_C = \Omega_0 \mathbf{1} + \vec{\Omega} \cdot \vec{\mathbf{S}} \\
 &= \frac{A+D}{2} \begin{pmatrix} 1 & 0 \\ 0 & 1 \end{pmatrix} + (A-D) \begin{pmatrix} \frac{1}{2} & 0 \\ 0 & -\frac{1}{2} \end{pmatrix} + 2B \begin{pmatrix} 0 & \frac{1}{2} \\ \frac{1}{2} & 0 \end{pmatrix} + 2C \begin{pmatrix} 0 & -\frac{i}{2} \\ \frac{i}{2} & 0 \end{pmatrix} && \text{Notation for 3D Vector space} \\
 &\quad \text{\small } 0^{\text{th}} \text{ component unchanged} \quad \text{\small components } A, B, C \text{ switch } 1/2\text{-factor from } \omega\text{-velocity to } S\text{-momentum}
 \end{aligned}$$

Symmetry archetypes: *A* (Asymmetric-diagonal) | *B* (Bilateral-balanced) | *C* (Chiral-circular-complex...)

"Crank" vector

The $\{\sigma_1, \sigma_A, \sigma_B, \sigma_C\}$ are the well known *Pauli-spin operators* $\{\sigma_1 = \sigma_0, \sigma_B = \sigma_X, \sigma_C = \sigma_Y, \sigma_A = \sigma_Z\}$

The $\{\mathbf{1}, \mathbf{S}_A, \mathbf{S}_B, \mathbf{S}_C\}$ are the *Jordan-Angular-Momentum operators* $\{\mathbf{1} = \sigma_0, \mathbf{S}_B = \mathbf{S}_X, \mathbf{S}_C = \mathbf{S}_Y, \mathbf{S}_A = \mathbf{S}_Z\}$

$$\vec{\varphi} = \begin{pmatrix} \varphi_A \\ \varphi_B \\ \varphi_C \end{pmatrix} = \vec{\omega} \cdot t = \begin{pmatrix} \omega_A \\ \omega_B \\ \omega_C \end{pmatrix} \cdot t = \begin{pmatrix} \frac{A-D}{2} \\ B \\ C \end{pmatrix} \cdot t$$

(Often labeled $\{J_X, J_Y, J_Z\}$)

Notation for 2D Spinor space

where: $\vec{\varphi} = \vec{\omega} \cdot t = \begin{pmatrix} \omega_A \\ \omega_B \\ \omega_C \end{pmatrix} \cdot t = \begin{pmatrix} \frac{A-D}{2} \\ B \\ C \end{pmatrix} \cdot t$ and: $\omega_0 = \frac{A+D}{2}$

$$e^{-i\mathbf{H}t} = e^{-i \begin{pmatrix} A & B-iC \\ B+iC & D \end{pmatrix} t} = e^{-i(\omega_0 \sigma_0 + \vec{\omega} \cdot \vec{\sigma})t} = e^{-i\omega_0 t} e^{-i \vec{\omega} \cdot \vec{\sigma} t} = e^{-i\omega_0 t} e^{-i \sigma_\omega \omega t} = e^{-i\omega_0 t} (\mathbf{1} \cos \omega t - i \sigma_\omega \sin \omega t)$$

"Crank" vector

$$= e^{-i(\Omega_0 \mathbf{1} + \vec{\Omega} \cdot \vec{\mathbf{S}})t} = e^{-i\Omega_0 t} e^{-i \vec{\Omega} \cdot \vec{\mathbf{S}} t} = e^{-i\Omega_0 t} \left(\mathbf{1} \cos \frac{\Omega t}{2} - i \sigma_\omega \sin \frac{\Omega t}{2} \right)$$

$$\vec{\Theta} = \begin{pmatrix} \Theta_A \\ \Theta_B \\ \Theta_C \end{pmatrix} = \vec{\Omega} \cdot t = \begin{pmatrix} \Omega_A \\ \Omega_B \\ \Omega_C \end{pmatrix} \cdot t = \begin{pmatrix} A-D \\ 2B \\ 2C \end{pmatrix} \cdot t$$

Notation for 3D Vector space

where: $\vec{\Theta} = \vec{\Omega} \cdot t = \begin{pmatrix} \Omega_A \\ \Omega_B \\ \Omega_C \end{pmatrix} \cdot t = \begin{pmatrix} A-D \\ 2B \\ 2C \end{pmatrix} \cdot t$ and: $\Omega_0 = \frac{A+D}{2}$

Review: How C_2 (Bilateral σ_B reflection) symmetry is eigen-solver

$U(2)$ vs $R(3)$: 2-State Schrodinger: $i\hbar\partial_t|\Psi(t)\rangle = \mathbf{H}|\Psi(t)\rangle$ vs. Classical 2D-HO: $\partial_t^2\mathbf{x} = -\mathbf{K}\cdot\mathbf{x}$

Hamilton-Pauli spinor symmetry (σ -expansion in $ABCD$ -Types) $\mathbf{H} = \omega_\mu\sigma_\mu$

Deriving σ -exponential time evolution (or revolution) operator $\mathbf{U} = e^{-i\mathbf{H}t} = e^{-i\sigma_\mu\omega_\mu t}$

Spinor arithmetic like complex arithmetic

Spinor vector algebra like complex vector algebra

Spinor exponentials like complex exponentials ("Crazy-Thing"-Theorem)

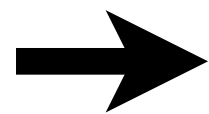

Geometry of $U(2)$ evolution (or $R(3)$ revolution) operator $\mathbf{U} = e^{-i\mathbf{H}t} = e^{-i\sigma_\mu\omega_\mu t}$

The "mysterious" factors of 2 (or 1/2): 2D Spinor vs 3D Spin Vector space

→ 2D Spinor vs 3D vector rotation

NMR Hamiltonian: 3D Spin Moment \mathbf{m} in \mathbf{B} field

Euler's state definition using rotations $\mathbf{R}(\alpha, 0, 0)$, $\mathbf{R}(0, \beta, 0)$, and $\mathbf{R}(0, 0, \gamma)$

Spin-1 (3D-real vector) case

Spin-1/2 (2D-complex spinor) case

3D-real Stokes Vector defines 2D-HO polarization ellipses and spinor states

Asymmetry $S_A = S_Z$, Balance $S_B = S_X$, and Chirality $S_C = S_Y$

Polarization ellipse and spinor state dynamics

The "mysterious" factors of 2 (or 1/2): 2D Spinor vs 3D Spin Vector space

$U(2)$: 2D Spinor $\{|\uparrow\rangle, |\downarrow\rangle\}$ -space (complex)

$R(3)$: 3D Spin Vector $\{S_X, S_Y, S_Z\}$ -space (real)

State vector $|\Psi\rangle = |\uparrow\rangle\langle\uparrow|\Psi\rangle + |\downarrow\rangle\langle\downarrow|\Psi\rangle$

Spin vector $\mathbf{S} = |X\rangle\langle X|\mathbf{S}\rangle + |Y\rangle\langle Y|\mathbf{S}\rangle + |Z\rangle\langle Z|\mathbf{S}\rangle$

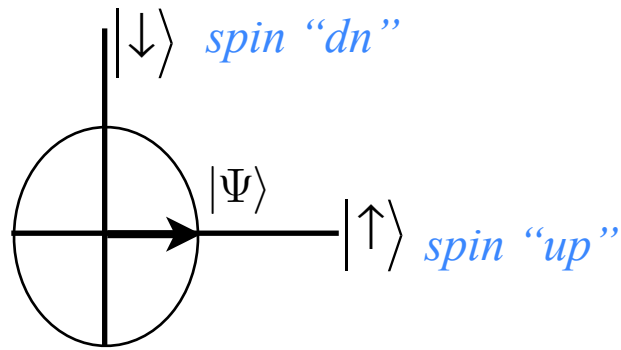

$$\begin{pmatrix} \Psi_{\uparrow} \\ \Psi_{\downarrow} \end{pmatrix} = \begin{pmatrix} 1 \\ 0 \end{pmatrix}$$

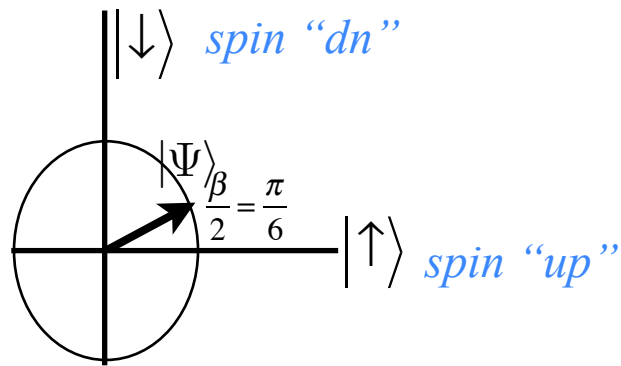

$$\begin{pmatrix} \Psi_{\uparrow} \\ \Psi_{\downarrow} \end{pmatrix} = \begin{pmatrix} \cos\frac{\beta}{2} & -\sin\frac{\beta}{2} \\ \sin\frac{\beta}{2} & \cos\frac{\beta}{2} \end{pmatrix} \begin{pmatrix} 1 \\ 0 \end{pmatrix} = \begin{pmatrix} \cos\frac{\beta}{2} \\ \sin\frac{\beta}{2} \end{pmatrix} = \begin{pmatrix} \frac{\sqrt{3}}{2} \\ \frac{1}{2} \end{pmatrix}$$

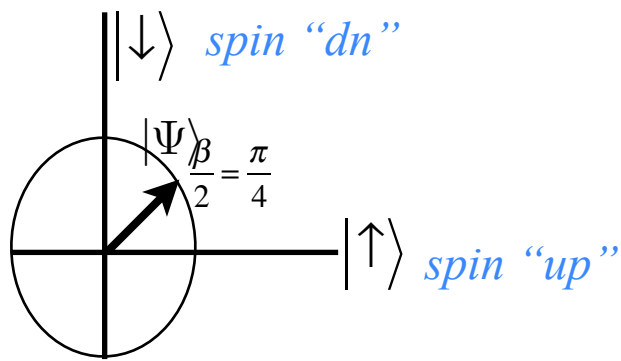

$$\begin{pmatrix} \Psi_{\uparrow} \\ \Psi_{\downarrow} \end{pmatrix} = \begin{pmatrix} \cos\frac{\beta}{2} \\ \sin\frac{\beta}{2} \end{pmatrix} = \begin{pmatrix} \frac{1}{\sqrt{2}} \\ \frac{1}{\sqrt{2}} \end{pmatrix}$$

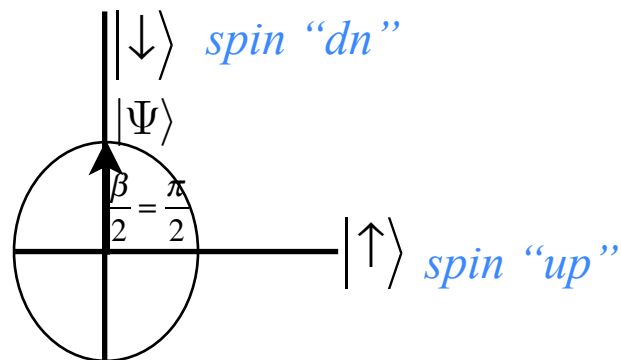

$$\begin{pmatrix} \Psi_{\uparrow} \\ \Psi_{\downarrow} \end{pmatrix} = \begin{pmatrix} \cos\frac{\beta}{2} \\ \sin\frac{\beta}{2} \end{pmatrix} = \begin{pmatrix} 0 \\ 1 \end{pmatrix}$$

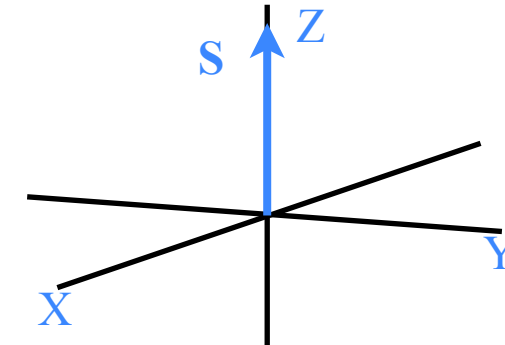

$$\begin{pmatrix} S_X \\ S_Y \\ S_Z \end{pmatrix} = \begin{pmatrix} 0 \\ 0 \\ 1 \end{pmatrix}$$

$$\begin{pmatrix} S_X \\ S_Y \\ S_Z \end{pmatrix} = \begin{pmatrix} \cos\beta & 0 & \sin\beta \\ 0 & 1 & 0 \\ -\sin\beta & 0 & \cos\beta \end{pmatrix} \begin{pmatrix} 0 \\ 0 \\ 1 \end{pmatrix}$$

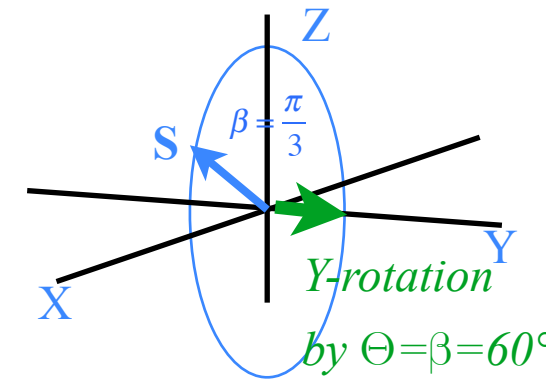

$$\begin{pmatrix} S_X \\ S_Y \\ S_Z \end{pmatrix} = \begin{pmatrix} \sin\beta \\ 0 \\ \cos\beta \end{pmatrix} = \begin{pmatrix} \sqrt{3}/2 \\ 0 \\ 1/2 \end{pmatrix}$$

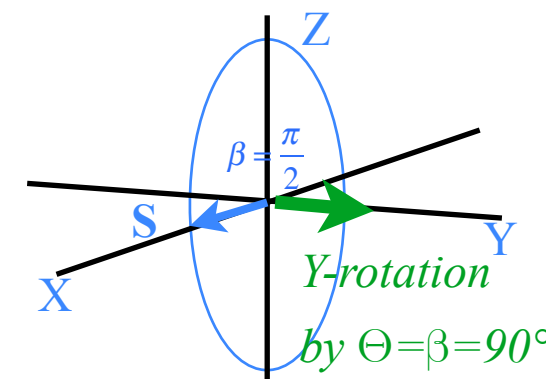

$$\begin{pmatrix} S_X \\ S_Y \\ S_Z \end{pmatrix} = \begin{pmatrix} \sin\beta \\ 0 \\ \cos\beta \end{pmatrix} = \begin{pmatrix} 1 \\ 0 \\ 0 \end{pmatrix}$$

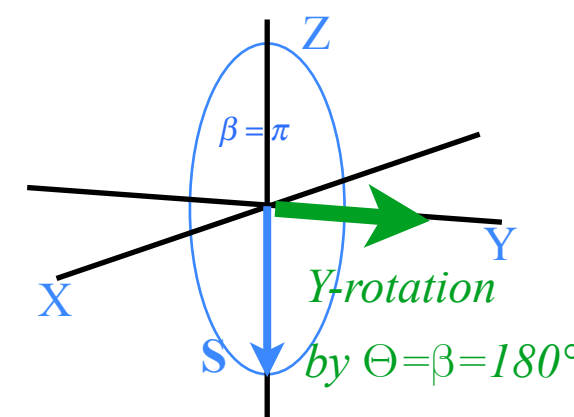

$$\begin{pmatrix} S_X \\ S_Y \\ S_Z \end{pmatrix} = \begin{pmatrix} \sin\beta \\ 0 \\ \cos\beta \end{pmatrix} = \begin{pmatrix} 0 \\ 0 \\ -1 \end{pmatrix}$$

Life in 2D Spinor space is "Half-Fast"

The "mysterious" factors of 2 (or 1/2): 2D Spinor vs 3D Spin Vector space

$U(2)$: 2D Spinor $\{|\uparrow\rangle, |\downarrow\rangle\}$ -space (complex)

$R(3)$: 3D Spin Vector $\{S_X, S_Y, S_Z\}$ -space (real)

State vector $|\Psi\rangle = |\uparrow\rangle\langle\uparrow|\Psi\rangle + |\downarrow\rangle\langle\downarrow|\Psi\rangle$

Spin vector $\mathbf{S} = |X\rangle\langle X|\mathbf{S}\rangle + |Y\rangle\langle Y|\mathbf{S}\rangle + |Z\rangle\langle Z|\mathbf{S}\rangle$

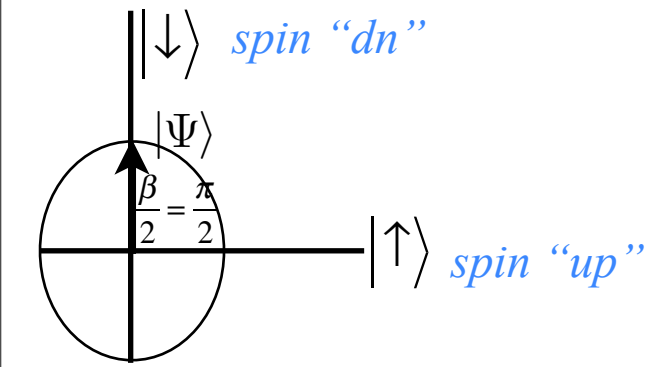

$$\begin{pmatrix} \Psi_{\uparrow} \\ \Psi_{\downarrow} \end{pmatrix} = \begin{pmatrix} \cos \frac{\beta}{2} \\ \sin \frac{\beta}{2} \end{pmatrix} = \begin{pmatrix} 0 \\ 1 \end{pmatrix}$$

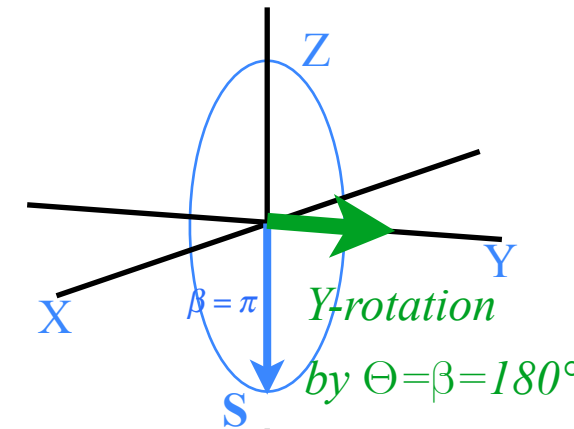

$$\begin{pmatrix} S_X \\ S_Y \\ S_Z \end{pmatrix} = \begin{pmatrix} \sin \beta \\ 0 \\ \cos \beta \end{pmatrix} = \begin{pmatrix} 0 \\ 0 \\ -1 \end{pmatrix}$$

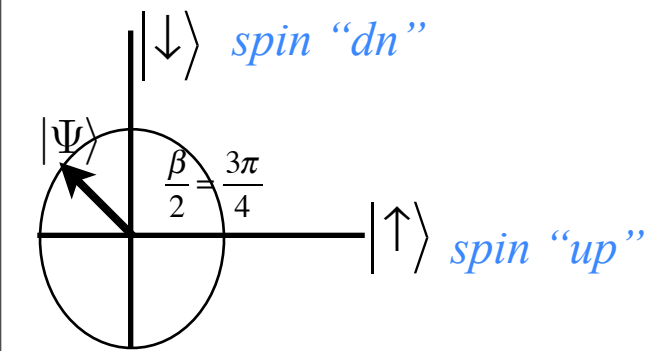

$$\begin{pmatrix} \Psi_{\uparrow} \\ \Psi_{\downarrow} \end{pmatrix} = \begin{pmatrix} \cos \frac{\beta}{2} \\ \sin \frac{\beta}{2} \end{pmatrix} = \begin{pmatrix} -\frac{1}{\sqrt{2}} \\ \frac{1}{\sqrt{2}} \end{pmatrix}$$

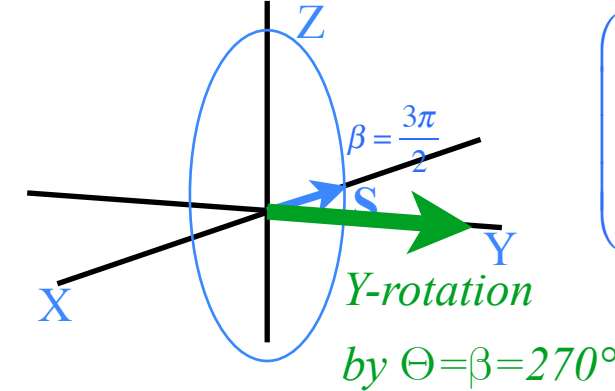

$$\begin{pmatrix} S_X \\ S_Y \\ S_Z \end{pmatrix} = \begin{pmatrix} \sin \beta \\ 0 \\ \cos \beta \end{pmatrix} = \begin{pmatrix} -1 \\ 0 \\ 0 \end{pmatrix}$$

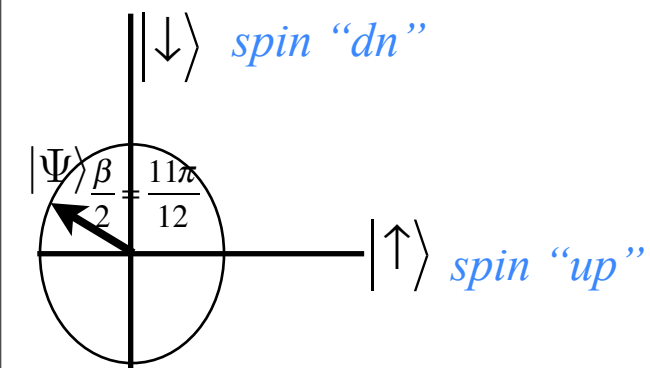

$$\begin{pmatrix} \Psi_{\uparrow} \\ \Psi_{\downarrow} \end{pmatrix} = \begin{pmatrix} \cos \frac{\beta}{2} \\ \sin \frac{\beta}{2} \end{pmatrix} = \begin{pmatrix} -\frac{\sqrt{3}}{2} \\ \frac{1}{2} \end{pmatrix}$$

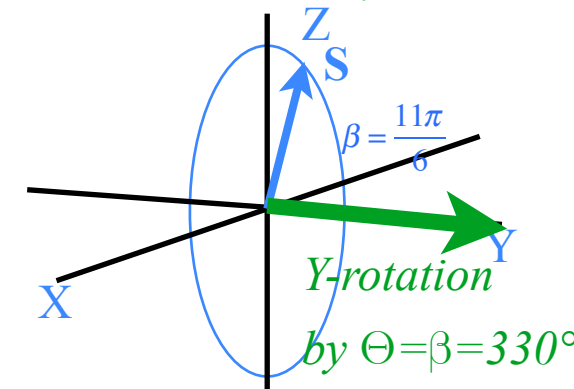

$$\begin{pmatrix} S_X \\ S_Y \\ S_Z \end{pmatrix} = \begin{pmatrix} \sin \beta \\ 0 \\ \cos \beta \end{pmatrix} =$$

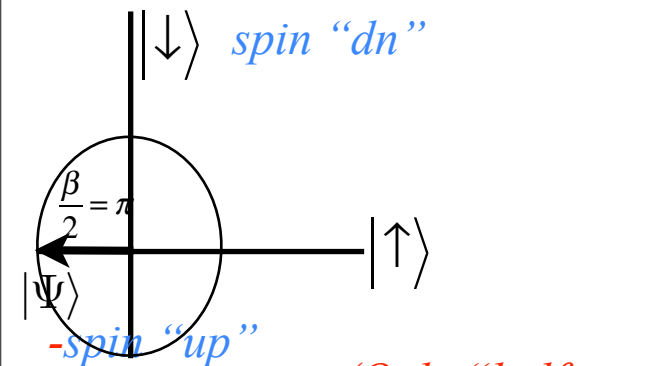

$$\begin{pmatrix} \Psi_{\uparrow} \\ \Psi_{\downarrow} \end{pmatrix} = \begin{pmatrix} \cos \frac{\beta}{2} \\ \sin \frac{\beta}{2} \end{pmatrix} = \begin{pmatrix} -1 \\ 0 \end{pmatrix}$$

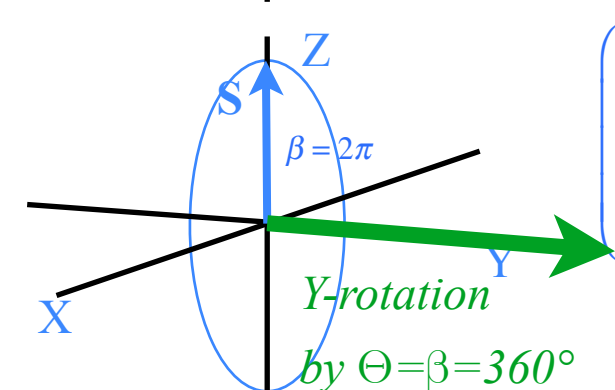

$$\begin{pmatrix} S_X \\ S_Y \\ S_Z \end{pmatrix} = \begin{pmatrix} 1 \\ 0 \\ 0 \end{pmatrix}$$

with π -phase (Only "half-way" home after $2\pi = 360^\circ$ rotation)

Life in 2D Spinor space is "Half-Fast" and needs $\Theta = 4\pi = 720^\circ$ to return to original state

Review: How C_2 (Bilateral σ_B reflection) symmetry is eigen-solver

$U(2)$ vs $R(3)$: 2-State Schrodinger: $i\hbar\partial_t|\Psi(t)\rangle = \mathbf{H}|\Psi(t)\rangle$ vs. Classical 2D-HO: $\partial_t^2\mathbf{x} = -\mathbf{K}\cdot\mathbf{x}$

Hamilton-Pauli spinor symmetry (σ -expansion in ABCD-Types) $\mathbf{H} = \omega_\mu\sigma_\mu$

Deriving σ -exponential time evolution (or revolution) operator $\mathbf{U} = e^{-i\mathbf{H}t} = e^{-i\sigma_\mu\omega_\mu t}$

Spinor arithmetic like complex arithmetic

Spinor vector algebra like complex vector algebra

Spinor exponentials like complex exponentials ("Crazy-Thing"-Theorem)

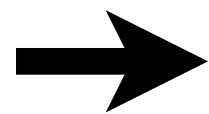

Geometry of $U(2)$ evolution (or $R(3)$ revolution) operator $\mathbf{U} = e^{-i\mathbf{H}t} = e^{-i\sigma_\mu\omega_\mu t}$

The "mysterious" factors of 2 (or 1/2): 2D Spinor vs 3D Spin Vector space

2D Spinor vs 3D vector rotation

→ NMR Hamiltonian: 3D Spin Moment \mathbf{m} in \mathbf{B} field

Euler's state definition using rotations $\mathbf{R}(\alpha, 0, 0)$, $\mathbf{R}(0, \beta, 0)$, and $\mathbf{R}(0, 0, \gamma)$

Spin-1 (3D-real vector) case

Spin-1/2 (2D-complex spinor) case

3D-real Stokes Vector defines 2D-HO polarization ellipses and spinor states

Asymmetry $S_A = S_Z$, Balance $S_B = S_X$, and Chirality $S_C = S_Y$

Polarization ellipse and spinor state dynamics

Hamiltonian for NMR: 3D Spin Moment Vector $\mathbf{m}=(m_x, m_y, m_z)$ in field $\mathbf{B}=(B_x, B_y, B_z)$

$$\mathbf{H}=\mathbf{m}\cdot\mathbf{B}=g\boldsymbol{\sigma}\cdot\mathbf{B}=\begin{pmatrix} gB_Z & gB_X-igB_Y \\ gB_X+igB_Y & -gB_Z \end{pmatrix}=gB_Z\begin{pmatrix} 1 & 0 \\ 0 & -1 \end{pmatrix}+gB_X\begin{pmatrix} 0 & 1 \\ 1 & 0 \end{pmatrix}+gB_Y\begin{pmatrix} 0 & -i \\ i & 0 \end{pmatrix}$$

$$=gB_Z\boldsymbol{\sigma}_A+gB_X\boldsymbol{\sigma}_X+gB_Y\boldsymbol{\sigma}_Y=\vec{\omega}\cdot\vec{\sigma}=\omega\boldsymbol{\sigma}_\omega$$

Notation for
2D Spinor space

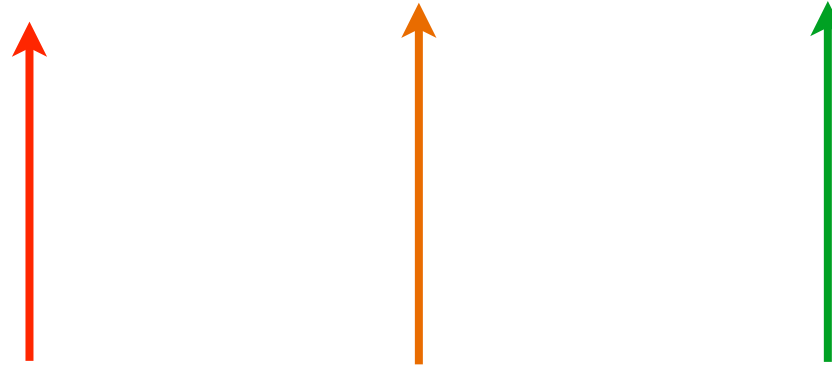

Symmetry archetypes: *A (Asymmetric-diagonal)* | *B (Bilateral-balanced)* | *C (Chiral-circular-complex...)*

The $\{\boldsymbol{\sigma}_I, \boldsymbol{\sigma}_A, \boldsymbol{\sigma}_B, \boldsymbol{\sigma}_C\}$ are the well known *Pauli-spin operators* $\{\boldsymbol{\sigma}_I=\boldsymbol{\sigma}_0, \boldsymbol{\sigma}_B=\boldsymbol{\sigma}_X, \boldsymbol{\sigma}_C=\boldsymbol{\sigma}_Y, \boldsymbol{\sigma}_A=\boldsymbol{\sigma}_Z\}$

Hamiltonian for NMR: 3D Spin Moment Vector $\mathbf{m}=(m_x, m_y, m_z)$ in field $\mathbf{B}=(B_x, B_y, B_z)$

$$\mathbf{H}=\mathbf{m}\cdot\mathbf{B}=g\boldsymbol{\sigma}\cdot\mathbf{B}=\begin{pmatrix} gB_Z & gB_X-igB_Y \\ gB_X+igB_Y & -gB_Z \end{pmatrix}=gB_Z\begin{pmatrix} 1 & 0 \\ 0 & -1 \end{pmatrix}+gB_X\begin{pmatrix} 0 & 1 \\ 1 & 0 \end{pmatrix}+gB_Y\begin{pmatrix} 0 & -i \\ i & 0 \end{pmatrix}$$

$$=gB_Z\boldsymbol{\sigma}_A+gB_X\boldsymbol{\sigma}_X+gB_Y\boldsymbol{\sigma}_Y=\vec{\omega}\cdot\vec{\sigma}=\omega\boldsymbol{\sigma}_\omega$$

Notation for
2D Spinor space

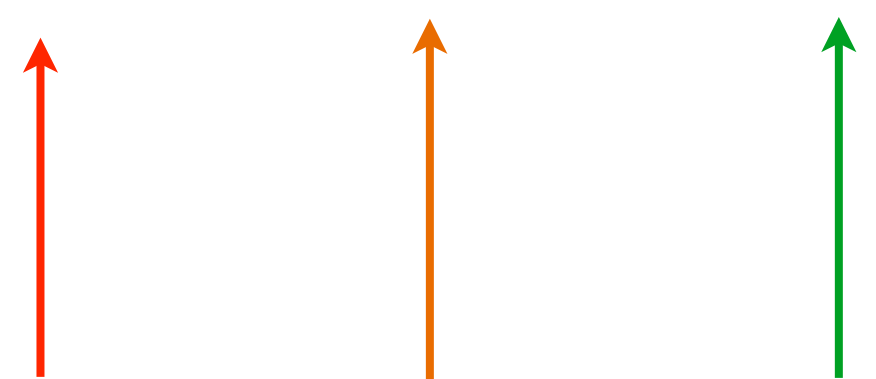

Symmetry archetypes: *A (Asymmetric-diagonal) | B (Bilateral-balanced) | C (Chiral-circular-complex...)*

The $\{\boldsymbol{\sigma}_I, \boldsymbol{\sigma}_A, \boldsymbol{\sigma}_B, \boldsymbol{\sigma}_C\}$ are the well known *Pauli-spin operators* $\{\boldsymbol{\sigma}_I=\boldsymbol{\sigma}_0, \boldsymbol{\sigma}_B=\boldsymbol{\sigma}_X, \boldsymbol{\sigma}_C=\boldsymbol{\sigma}_Y, \boldsymbol{\sigma}_A=\boldsymbol{\sigma}_Z\}$

The driving $\Theta=\Omega t$ crank vector defined by *ABCD* of Hamiltonian \mathbf{H} .

Notation for
3D Vector space

$$\vec{\Theta}=\begin{pmatrix} \Theta_A \\ \Theta_B \\ \Theta_C \end{pmatrix}=\vec{\Omega}\cdot t=\begin{pmatrix} \Omega_A \\ \Omega_B \\ \Omega_C \end{pmatrix}\cdot t=\begin{pmatrix} A-D \\ 2B \\ 2C \end{pmatrix}\cdot t$$

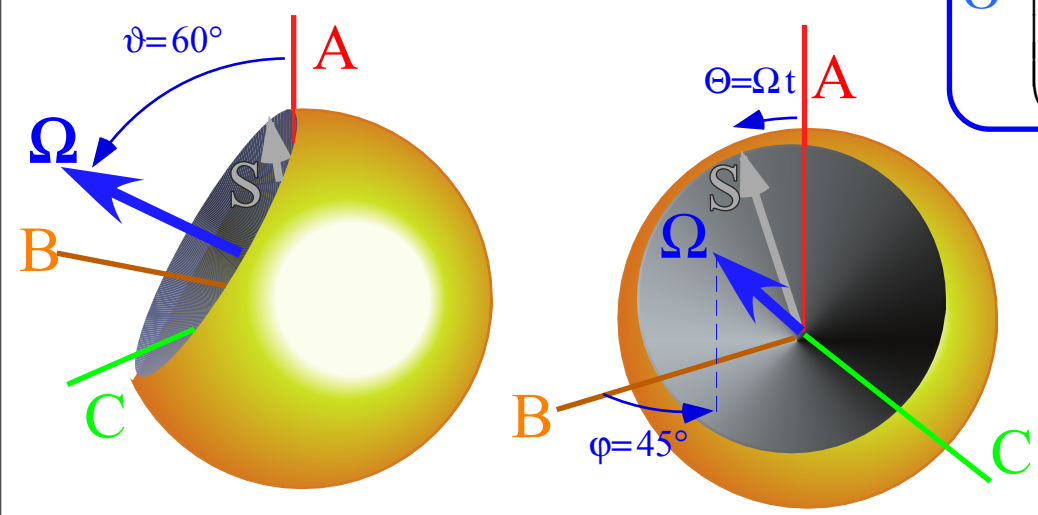

Two views of Hamilton crank vector $\Omega(\varphi, \vartheta)$ whirling Stokes state vector S in *ABC*-space.

Hamiltonian for NMR: 3D Spin Moment Vector $\mathbf{m}=(m_x, m_y, m_z)$ in field $\mathbf{B}=(B_x, B_y, B_z)$

$$\mathbf{H}=\mathbf{m}\cdot\mathbf{B}=g\boldsymbol{\sigma}\cdot\mathbf{B}=\begin{pmatrix} gB_Z & gB_X-igB_Y \\ gB_X+igB_Y & -gB_Z \end{pmatrix}=gB_Z\begin{pmatrix} 1 & 0 \\ 0 & -1 \end{pmatrix}+gB_X\begin{pmatrix} 0 & 1 \\ 1 & 0 \end{pmatrix}+gB_Y\begin{pmatrix} 0 & -i \\ i & 0 \end{pmatrix}$$

$$=gB_Z\boldsymbol{\sigma}_A+gB_X\boldsymbol{\sigma}_X+gB_Y\boldsymbol{\sigma}_Y=\vec{\omega}\cdot\vec{\sigma}=\omega\boldsymbol{\sigma}_\omega$$

Notation for
2D Spinor space

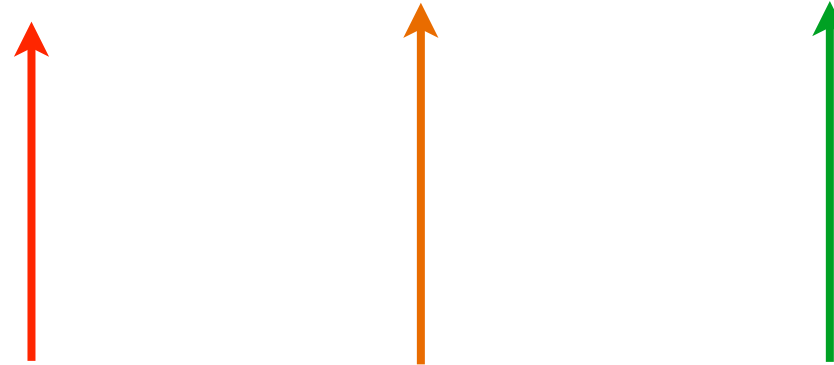

Symmetry archetypes: *A (Asymmetric-diagonal) | B (Bilateral-balanced) | C (Chiral-circular-complex...)*

The $\{\boldsymbol{\sigma}_I, \boldsymbol{\sigma}_A, \boldsymbol{\sigma}_B, \boldsymbol{\sigma}_C\}$ are the well known *Pauli-spin operators* $\{\boldsymbol{\sigma}_I=\boldsymbol{\sigma}_0, \boldsymbol{\sigma}_B=\boldsymbol{\sigma}_X, \boldsymbol{\sigma}_C=\boldsymbol{\sigma}_Y, \boldsymbol{\sigma}_A=\boldsymbol{\sigma}_Z\}$

The driving $\Theta=\Omega t$ crank vector defined by *ABCD* of Hamiltonian \mathbf{H} .

Notation for
3D Vector space

$$\vec{\Theta}=\begin{pmatrix} \Theta_A \\ \Theta_B \\ \Theta_C \end{pmatrix}=\vec{\Omega}\cdot t=\begin{pmatrix} \Omega_A \\ \Omega_B \\ \Omega_C \end{pmatrix}\cdot t=\begin{pmatrix} A-D \\ 2B \\ 2C \end{pmatrix}\cdot t=g\begin{pmatrix} B_Z \\ B_X \\ B_Y \end{pmatrix}\cdot t$$

For fermion spin that Ω is the $g\mathbf{B}$ -field!

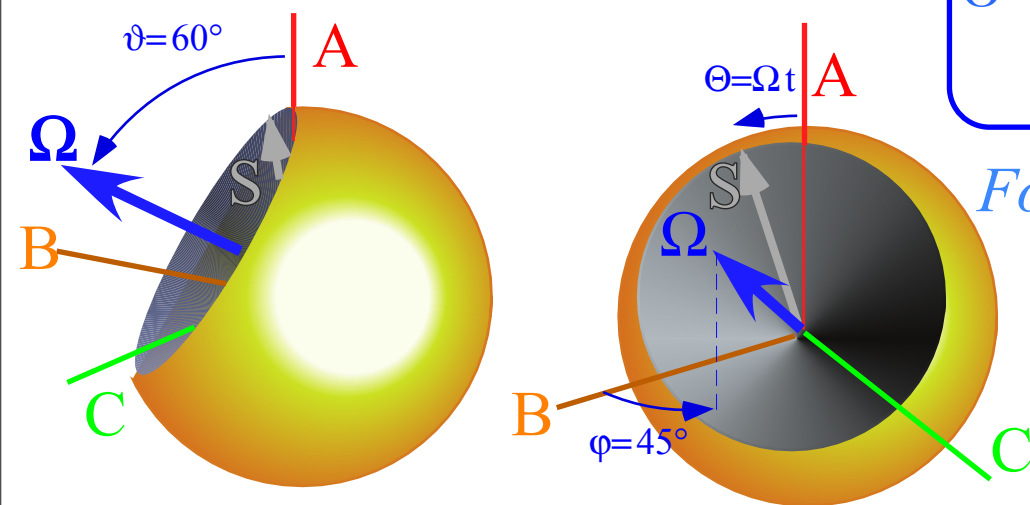

Two views of Hamilton crank vector $\Omega(\varphi, \vartheta)$ whirling Stokes state vector S in *ABC*-space.

Hamiltonian for NMR: 3D Spin Moment Vector $\mathbf{m}=(m_x, m_y, m_z)$ in field $\mathbf{B}=(B_x, B_y, B_z)$

$$\mathbf{H}=\mathbf{m}\cdot\mathbf{B}=g\boldsymbol{\sigma}\cdot\mathbf{B}=\begin{pmatrix} gB_Z & gB_X-igB_Y \\ gB_X+igB_Y & -gB_Z \end{pmatrix}=gB_Z\begin{pmatrix} 1 & 0 \\ 0 & -1 \end{pmatrix}+gB_X\begin{pmatrix} 0 & 1 \\ 1 & 0 \end{pmatrix}+gB_Y\begin{pmatrix} 0 & -i \\ i & 0 \end{pmatrix}$$

$$=gB_Z\boldsymbol{\sigma}_A+gB_X\boldsymbol{\sigma}_X+gB_Y\boldsymbol{\sigma}_Y=\vec{\omega}\cdot\vec{\sigma}=\omega\boldsymbol{\sigma}_\omega$$

Notation for
2D Spinor space

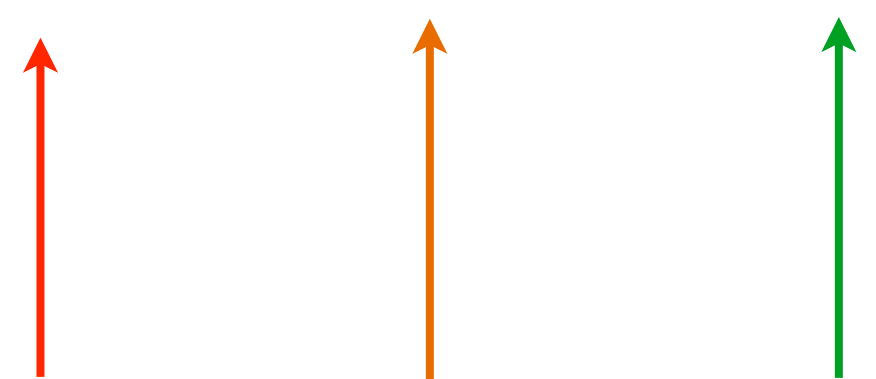

Symmetry archetypes: *A (Asymmetric-diagonal) | B (Bilateral-balanced) | C (Chiral-circular-complex...)*

The $\{\boldsymbol{\sigma}_I, \boldsymbol{\sigma}_A, \boldsymbol{\sigma}_B, \boldsymbol{\sigma}_C\}$ are the well known *Pauli-spin operators* $\{\boldsymbol{\sigma}_I=\boldsymbol{\sigma}_0, \boldsymbol{\sigma}_B=\boldsymbol{\sigma}_X, \boldsymbol{\sigma}_C=\boldsymbol{\sigma}_Y, \boldsymbol{\sigma}_A=\boldsymbol{\sigma}_Z\}$

The driving $\Theta=\Omega t$ crank vector defined by *ABCD* of Hamiltonian \mathbf{H} .

Notation for
3D Vector space

$$\vec{\Theta}=\begin{pmatrix} \Theta_A \\ \Theta_B \\ \Theta_C \end{pmatrix}=\vec{\Omega}\cdot t=\begin{pmatrix} \Omega_A \\ \Omega_B \\ \Omega_C \end{pmatrix}\cdot t=\begin{pmatrix} A-D \\ 2B \\ 2C \end{pmatrix}\cdot t=g\begin{pmatrix} B_Z \\ B_X \\ B_Y \end{pmatrix}\cdot t$$

For fermion spin that Ω is the $g\mathbf{B}$ -field!

Q: But, how is a spin state- $|\psi\rangle$ or spin vector- \mathbf{S} defined?

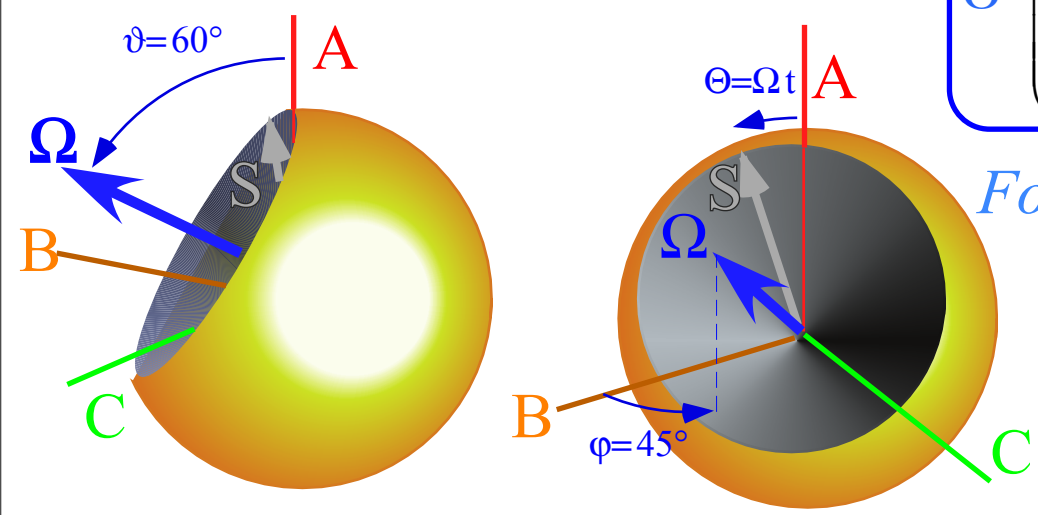

Two views of Hamilton crank vector $\Omega(\varphi, \vartheta)$ whirling Stokes state vector \mathbf{S} in *ABC*-space.

Hamiltonian for NMR: 3D Spin Moment Vector $\mathbf{m}=(m_x, m_y, m_z)$ in field $\mathbf{B}=(B_x, B_y, B_z)$

$$\mathbf{H}=\mathbf{m}\cdot\mathbf{B}=g\boldsymbol{\sigma}\cdot\mathbf{B}=\begin{pmatrix} gB_Z & gB_X-igB_Y \\ gB_X+igB_Y & -gB_Z \end{pmatrix}=gB_Z\begin{pmatrix} 1 & 0 \\ 0 & -1 \end{pmatrix}+gB_X\begin{pmatrix} 0 & 1 \\ 1 & 0 \end{pmatrix}+gB_Y\begin{pmatrix} 0 & -i \\ i & 0 \end{pmatrix}$$

$$=gB_Z\boldsymbol{\sigma}_A+gB_X\boldsymbol{\sigma}_X+gB_Y\boldsymbol{\sigma}_Y=\vec{\omega}\cdot\vec{\sigma}=\omega\boldsymbol{\sigma}_\omega$$

Notation for
2D Spinor space

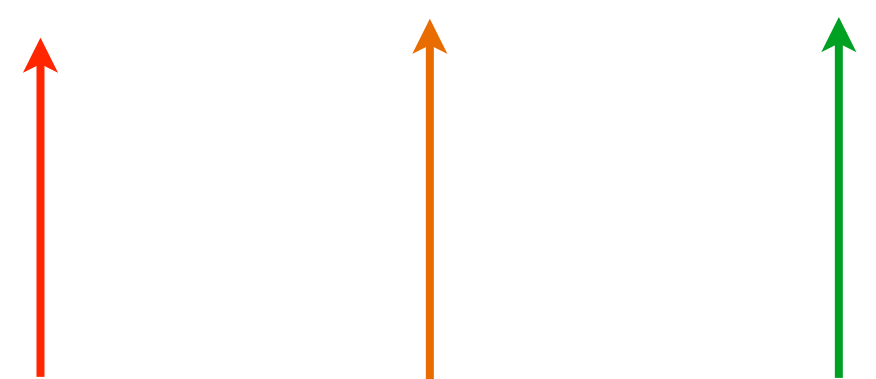

Symmetry archetypes: *A (Asymmetric-diagonal) | B (Bilateral-balanced) | C (Chiral-circular-complex...)*

The $\{\boldsymbol{\sigma}_I, \boldsymbol{\sigma}_A, \boldsymbol{\sigma}_B, \boldsymbol{\sigma}_C\}$ are the well known *Pauli-spin operators* $\{\boldsymbol{\sigma}_I=\boldsymbol{\sigma}_0, \boldsymbol{\sigma}_B=\boldsymbol{\sigma}_X, \boldsymbol{\sigma}_C=\boldsymbol{\sigma}_Y, \boldsymbol{\sigma}_A=\boldsymbol{\sigma}_Z\}$

The driving $\Theta=\Omega t$ crank vector defined by *ABCD* of Hamiltonian \mathbf{H} .

Notation for
3D Vector space

$$\vec{\Theta}=\begin{pmatrix} \Theta_A \\ \Theta_B \\ \Theta_C \end{pmatrix}=\vec{\Omega}\cdot t=\begin{pmatrix} \Omega_A \\ \Omega_B \\ \Omega_C \end{pmatrix}\cdot t=\begin{pmatrix} A-D \\ 2B \\ 2C \end{pmatrix}\cdot t=g\begin{pmatrix} B_Z \\ B_X \\ B_Y \end{pmatrix}\cdot t$$

For fermion spin that Ω is the $g\mathbf{B}$ -field!

Q: But, how is a spin state- $|\psi\rangle$ or spin vector- \mathbf{S} defined?

A: By $U(2)$ group operator $|\psi(t)\rangle=\mathbf{R}[\Theta]|\psi(0)\rangle$.

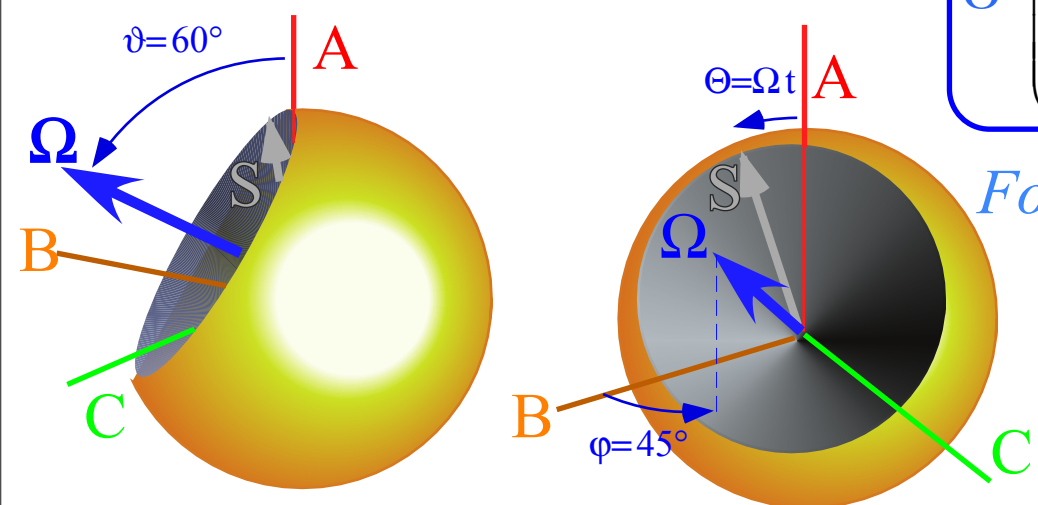

Two views of Hamilton crank vector $\Omega(\varphi, \vartheta)$ whirling Stokes state vector \mathbf{S} in *ABC*-space.

Review: How C_2 (Bilateral σ_B reflection) symmetry is eigen-solver

$U(2)$ vs $R(3)$: 2-State Schrodinger: $i\hbar\partial_t|\Psi(t)\rangle = \mathbf{H}|\Psi(t)\rangle$ vs. Classical 2D-HO: $\partial_t^2\mathbf{x} = -\mathbf{K}\cdot\mathbf{x}$
Hamilton-Pauli spinor symmetry (σ -expansion in $ABCD$ -Types) $\mathbf{H} = \omega_\mu\sigma_\mu$

Deriving σ -exponential time evolution (or revolution) operator $\mathbf{U} = e^{-i\mathbf{H}t} = e^{-i\sigma_\mu\omega_\mu t}$

Spinor arithmetic like complex arithmetic

Spinor vector algebra like complex vector algebra

Spinor exponentials like complex exponentials ("Crazy-Thing"-Theorem)

Geometry of $U(2)$ evolution (or $R(3)$ revolution) operator $\mathbf{U} = e^{-i\mathbf{H}t} = e^{-i\sigma_\mu\omega_\mu t}$

The "mysterious" factors of 2 (or 1/2): 2D Spinor vs 3D Spin Vector space

2D Spinor vs 3D vector rotation

NMR Hamiltonian: 3D Spin Moment \mathbf{m} in \mathbf{B} field

→ Euler's state definition using rotations $\mathbf{R}(\alpha, 0, 0)$, $\mathbf{R}(0, \beta, 0)$, and $\mathbf{R}(0, 0, \gamma)$

→ Spin-1 (3D-real vector) case

Spin-1/2 (2D-complex spinor) case

3D-real Stokes Vector defines 2D-HO polarization ellipses and spinor states

Asymmetry $S_A = S_Z$, Balance $S_B = S_X$, and Chirality $S_C = S_Y$

Polarization ellipse and spinor state dynamics

Euler's state definition using rotations $\mathbf{R}(\alpha, 0, 0)$, $\mathbf{R}(0, \beta, 0)$, and $\mathbf{R}(0, 0, \gamma)$

Spin-1 (3D-real vector) case

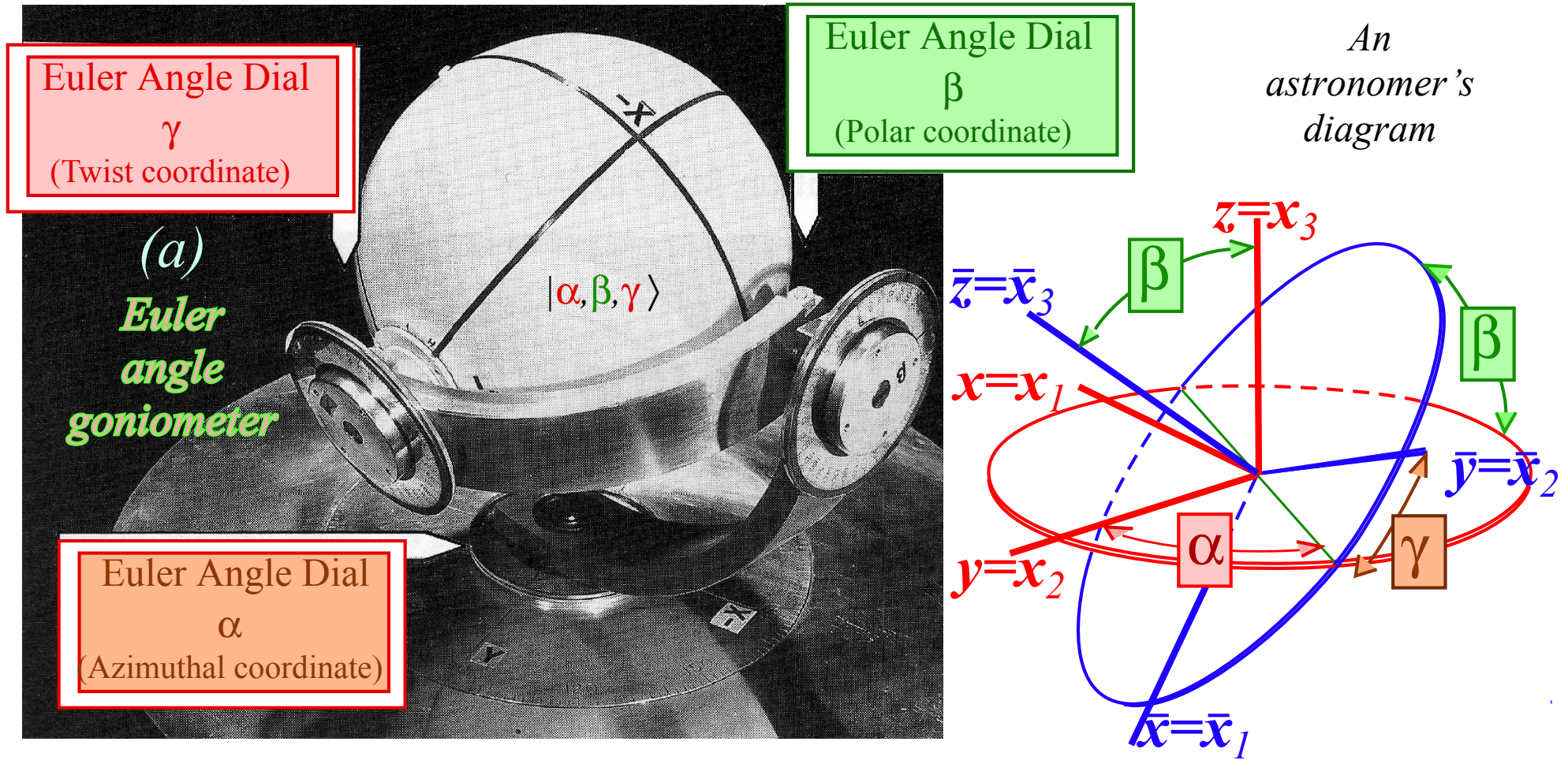

Euler's rotation state definition using rotations $\mathbf{R}(\alpha, 0, 0)$, $\mathbf{R}(0, \beta, 0)$, and $\mathbf{R}(0, 0, \gamma)$

Spin-1 (3D-real vector) case

Third rotation $\mathbf{R}(\alpha 0 0)$

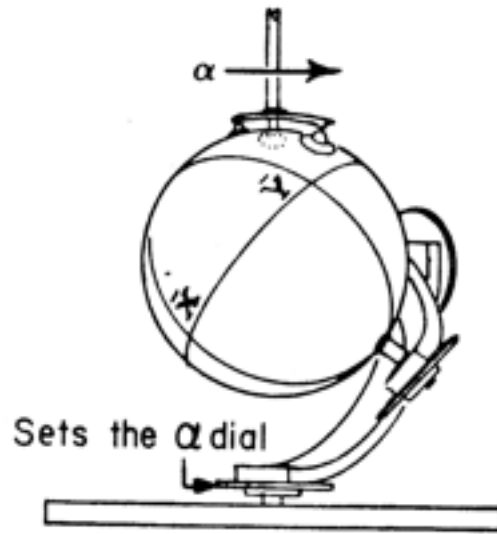

$$\langle R(\alpha\beta\gamma) \rangle = \langle R(\alpha 0 0) \rangle$$

Second rotation $\mathbf{R}(0\beta 0)$

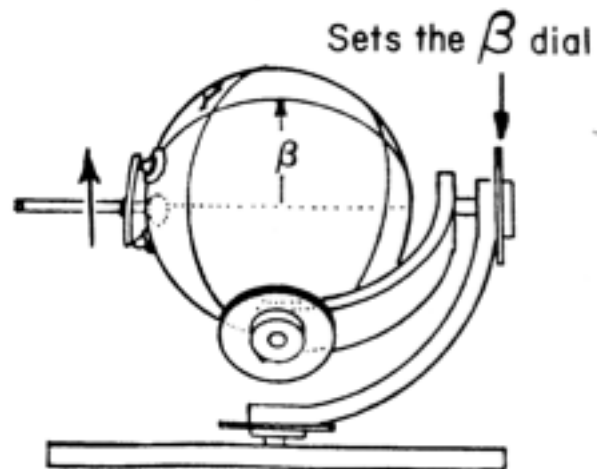

$$\langle R(0\beta 0) \rangle$$

First rotation $\mathbf{R}(0 0 \gamma)$

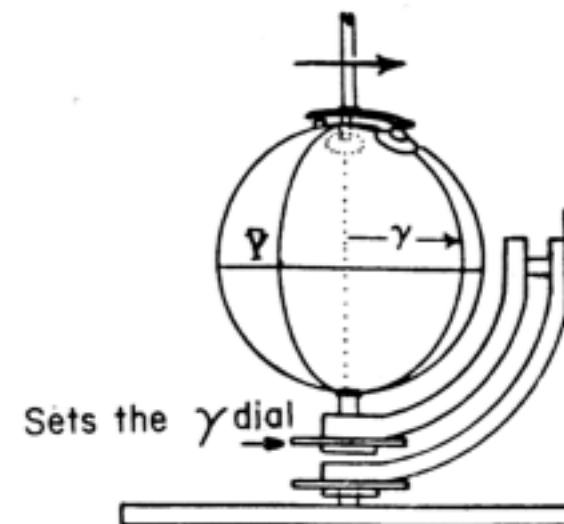

$$\langle R(0 0 \gamma) \rangle$$

Euler's rotation state definition using rotations $\mathbf{R}(\alpha, 0, 0)$, $\mathbf{R}(0, \beta, 0)$, and $\mathbf{R}(0, 0, \gamma)$

Spin-1 (3D-real vector) case

Third rotation $\mathbf{R}(\alpha 0 0)$

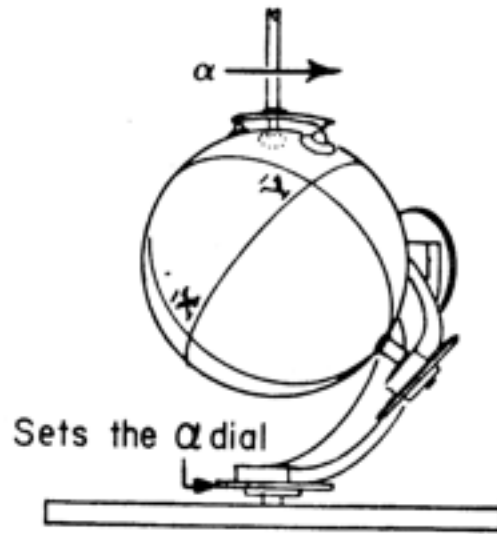

Second rotation $\mathbf{R}(0 \beta 0)$

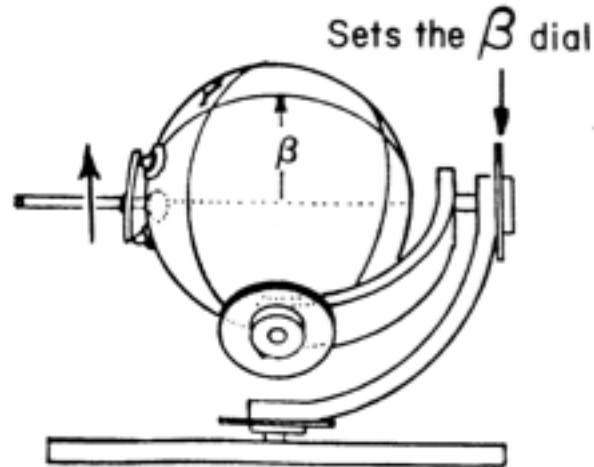

First rotation $\mathbf{R}(0 0 \gamma)$

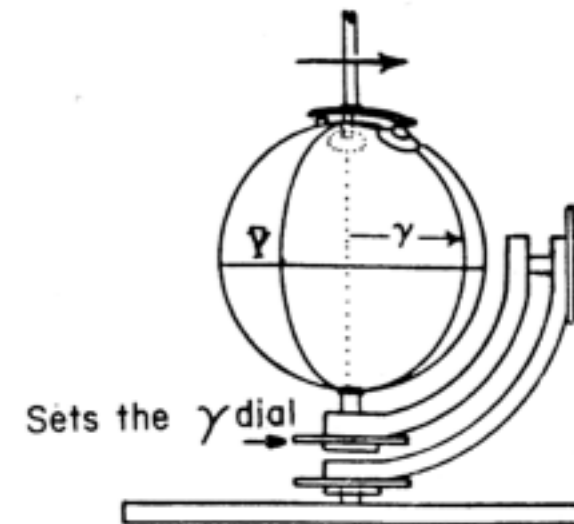

$$\langle R(\alpha\beta\gamma) \rangle = \langle R(\alpha 0 0) \rangle$$

$$\langle R(0\beta 0) \rangle$$

$$\langle R(0 0 \gamma) \rangle$$

$$= \begin{pmatrix} \cos\alpha & -\sin\alpha & 0 \\ \sin\alpha & \cos\alpha & 0 \\ 0 & 0 & 1 \end{pmatrix} \begin{pmatrix} \cos\beta & 0 & \sin\beta \\ 0 & 1 & 0 \\ -\sin\beta & 0 & \cos\beta \end{pmatrix} \begin{pmatrix} \cos\gamma & -\sin\gamma & 0 \\ \sin\gamma & \cos\gamma & 0 \\ 0 & 0 & 1 \end{pmatrix}$$

Euler's rotation state definition using rotations $\mathbf{R}(\alpha, 0, 0)$, $\mathbf{R}(0, \beta, 0)$, and $\mathbf{R}(0, 0, \gamma)$

Spin-1 (3D-real vector) case

Third rotation $\mathbf{R}(\alpha 0 0)$

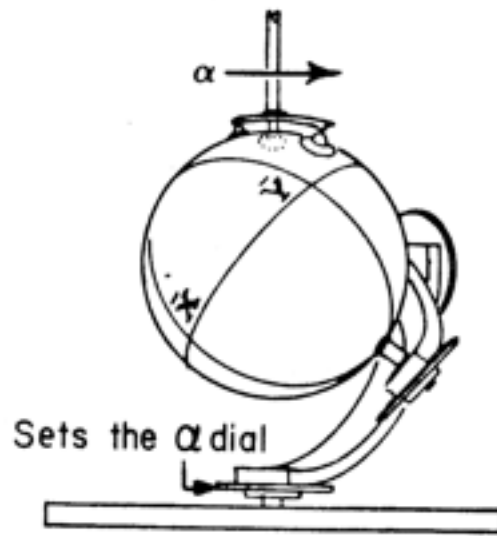

Second rotation $\mathbf{R}(0 \beta 0)$

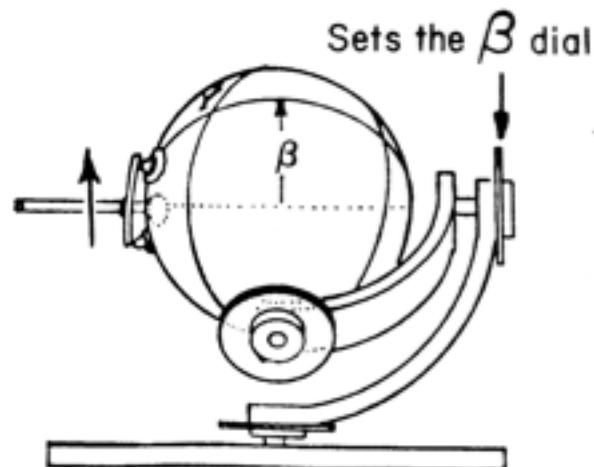

First rotation $\mathbf{R}(0 0 \gamma)$

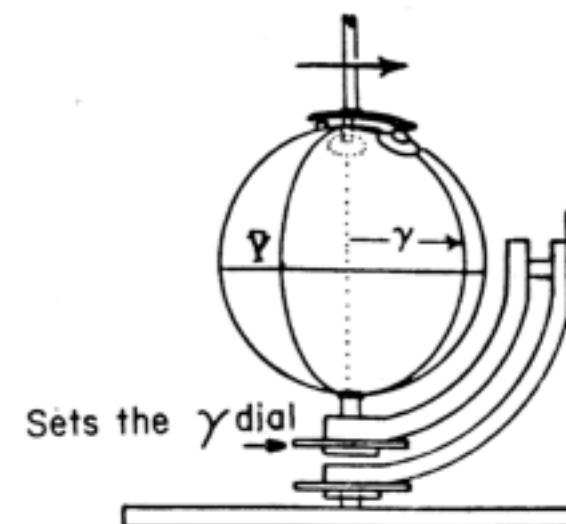

$$\langle R(\alpha\beta\gamma) \rangle = \langle R(\alpha 0 0) \rangle$$

$$\langle R(0\beta 0) \rangle$$

$$\langle R(0 0 \gamma) \rangle$$

$$= \begin{pmatrix} \cos\alpha & -\sin\alpha & 0 \\ \sin\alpha & \cos\alpha & 0 \\ 0 & 0 & 1 \end{pmatrix} \begin{pmatrix} \cos\beta & 0 & \sin\beta \\ 0 & 1 & 0 \\ -\sin\beta & 0 & \cos\beta \end{pmatrix} \begin{pmatrix} \cos\gamma & -\sin\gamma & 0 \\ \sin\gamma & \cos\gamma & 0 \\ 0 & 0 & 1 \end{pmatrix}$$

$$|\mathbf{e}_{\bar{x}}\rangle = R(\alpha\beta\gamma)|\mathbf{e}_x\rangle$$

$$|\mathbf{e}_{\bar{y}}\rangle = R(\alpha\beta\gamma)|\mathbf{e}_y\rangle$$

$$|\mathbf{e}_{\bar{z}}\rangle = R(\alpha\beta\gamma)|\mathbf{e}_z\rangle$$

$$\left(\begin{array}{l} \langle \mathbf{e}_x | \\ \langle \mathbf{e}_y | \\ \langle \mathbf{e}_z | \end{array} \right) R(\alpha\beta\gamma) \left(\begin{array}{l} |\mathbf{e}_x\rangle \\ |\mathbf{e}_y\rangle \\ |\mathbf{e}_z\rangle \end{array} \right) = \begin{pmatrix} \cos\alpha \cos\beta \cos\gamma - \sin\alpha \sin\gamma & -\cos\alpha \cos\beta \sin\gamma - \sin\alpha \cos\gamma & \cos\alpha \sin\beta \\ \sin\alpha \cos\beta \cos\gamma + \cos\alpha \sin\gamma & -\sin\alpha \cos\beta \sin\gamma + \cos\alpha \cos\gamma & \sin\alpha \sin\beta \\ -\cos\gamma \sin\beta & \sin\gamma \sin\beta & \cos\beta \end{pmatrix}$$

Note lab frame polar coordinates

Euler's rotation state definition using rotations $\mathbf{R}(\alpha,0,0)$, $\mathbf{R}(0,\beta,0)$, and $\mathbf{R}(0,0,\gamma)$

Spin-1 (3D-real vector) case

Third rotation $\mathbf{R}(\alpha 00)$

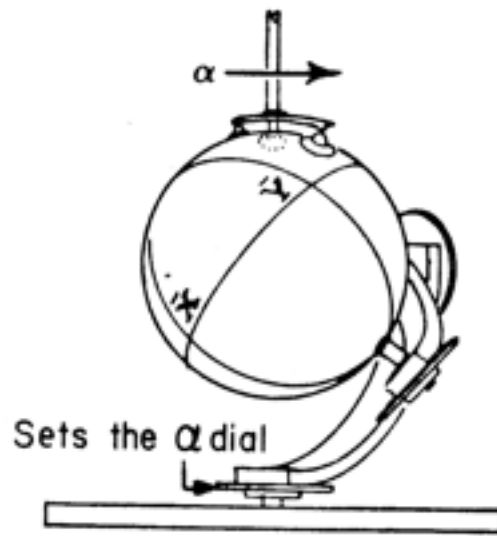

Second rotation $\mathbf{R}(0\beta 0)$

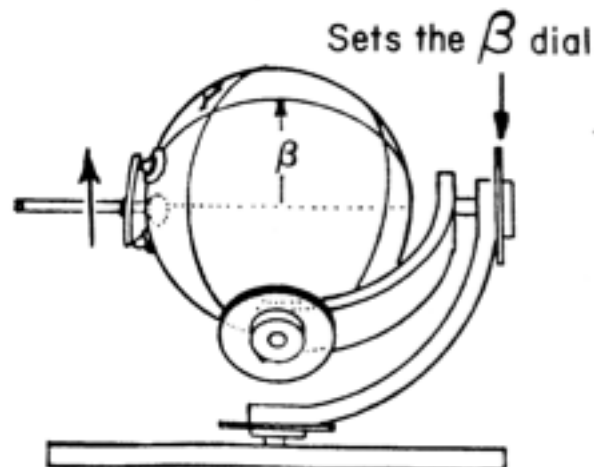

First rotation $\mathbf{R}(00\gamma)$

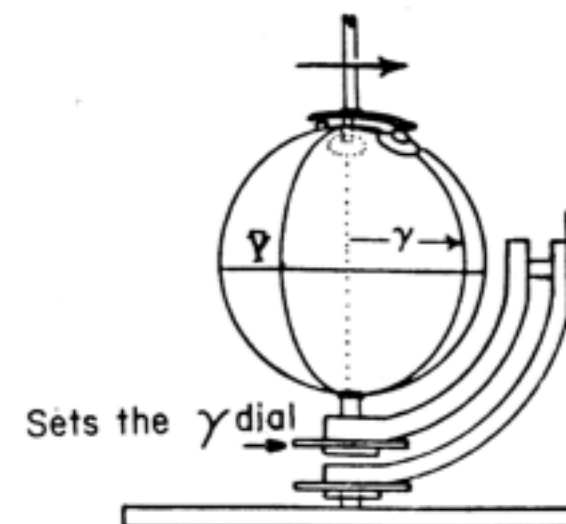

$$\langle R(\alpha\beta\gamma) \rangle = \langle R(\alpha 00) \rangle$$

$$\langle R(0\beta 0) \rangle$$

$$\langle R(00\gamma) \rangle$$

$$= \begin{pmatrix} \cos\alpha & -\sin\alpha & 0 \\ \sin\alpha & \cos\alpha & 0 \\ 0 & 0 & 1 \end{pmatrix} \begin{pmatrix} \cos\beta & 0 & \sin\beta \\ 0 & 1 & 0 \\ -\sin\beta & 0 & \cos\beta \end{pmatrix} \begin{pmatrix} \cos\gamma & -\sin\gamma & 0 \\ \sin\gamma & \cos\gamma & 0 \\ 0 & 0 & 1 \end{pmatrix}$$

$$|e_{\bar{x}}\rangle = R(\alpha\beta\gamma)|e_x\rangle \quad |e_{\bar{y}}\rangle = R(\alpha\beta\gamma)|e_y\rangle \quad |e_{\bar{z}}\rangle = R(\alpha\beta\gamma)|e_z\rangle$$

$$\langle e_A | R(\alpha\beta\gamma) | e_B \rangle = \begin{pmatrix} \langle e_x | \\ \langle e_y | \\ \langle e_z | \end{pmatrix} \begin{pmatrix} \cos\alpha \cos\beta \cos\gamma - \sin\alpha \sin\gamma & -\cos\alpha \cos\beta \sin\gamma - \sin\alpha \cos\gamma & \cos\alpha \sin\beta \\ \sin\alpha \cos\beta \cos\gamma + \cos\alpha \sin\gamma & -\sin\alpha \cos\beta \sin\gamma + \cos\alpha \cos\gamma & \sin\alpha \sin\beta \\ -\cos\gamma \sin\beta & \sin\gamma \sin\beta & \cos\beta \end{pmatrix}$$

Note lab-frame polar coordinates of Z(body)

...and body-frame polar coordinates

Euler's rotation state definition using rotations $\mathbf{R}(\alpha, 0, 0)$, $\mathbf{R}(0, \beta, 0)$, and $\mathbf{R}(0, 0, \gamma)$

Spin-1 (3D-real vector) case

BOD frame view

Polar angles of
LAB zenith $z=x_3$ are
(azimuth angle= $-\gamma$,
polar angle= $-\beta$)

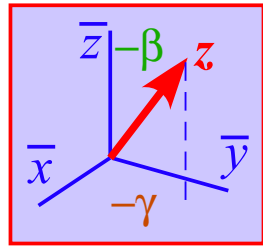

LAB frame view

Polar angles of
BOD zenith $\bar{z}=\bar{x}_3$ are
(azimuth angle= α ,
polar angle= β)

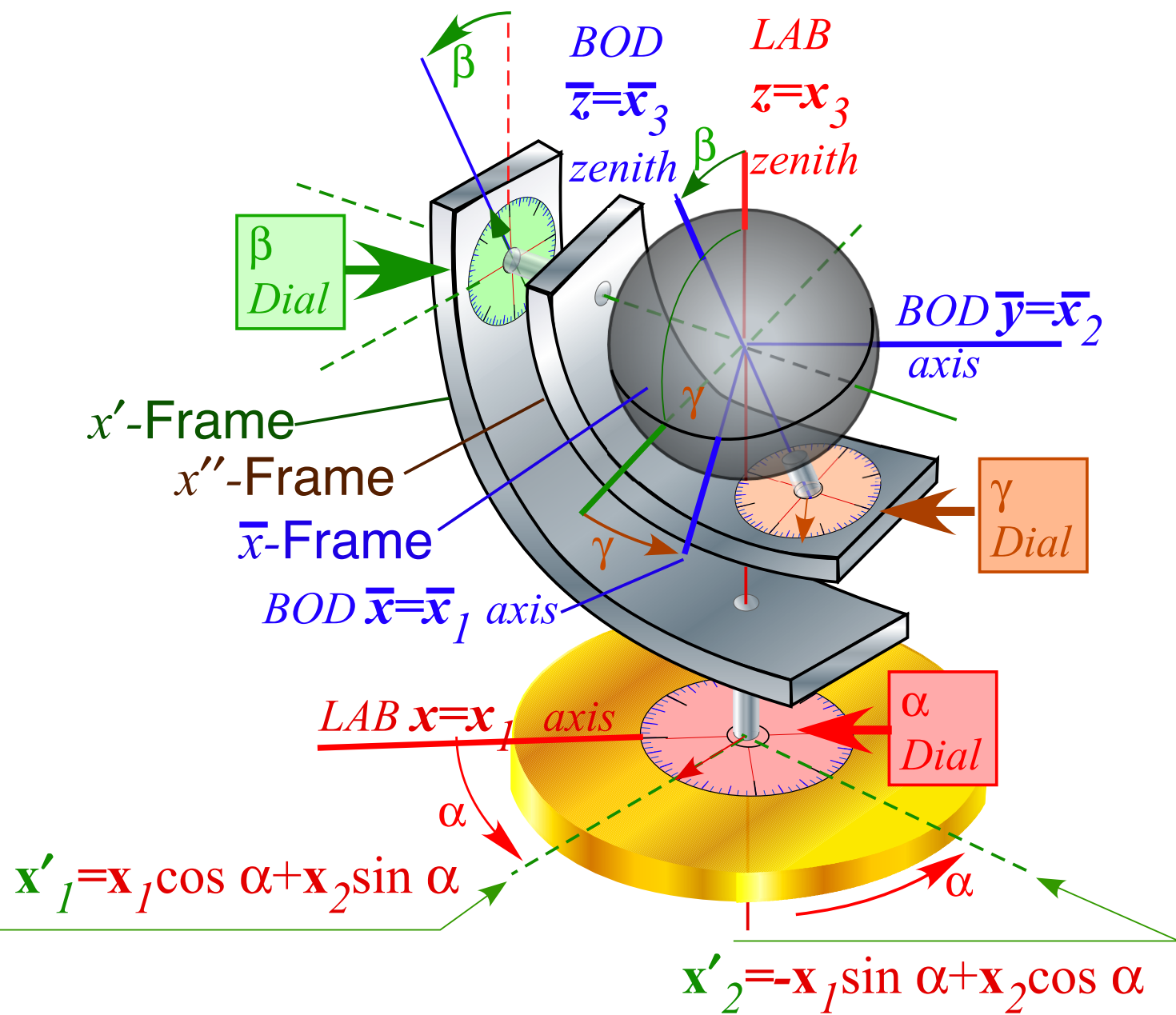
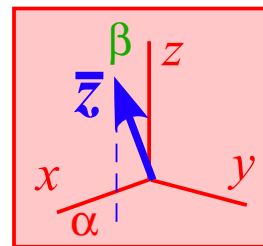

Fig. 10.A.3-4 Mechanical device demonstrating Euler angles (α, β, γ)

Euler's rotation state definition using rotations $\mathbf{R}(\alpha, 0, 0)$, $\mathbf{R}(0, \beta, 0)$, and $\mathbf{R}(0, 0, \gamma)$

Spin-1 (3D-real vector) case

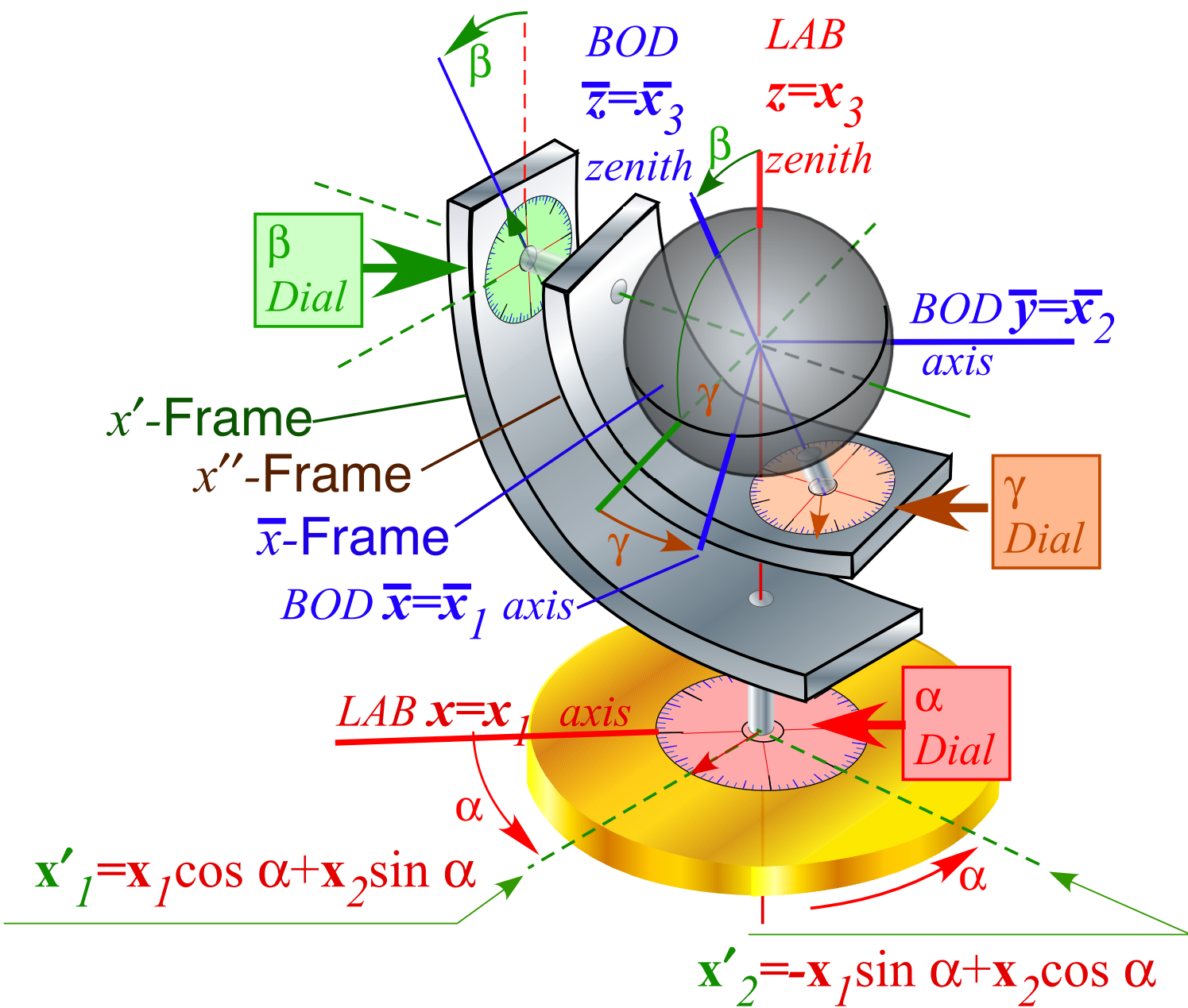
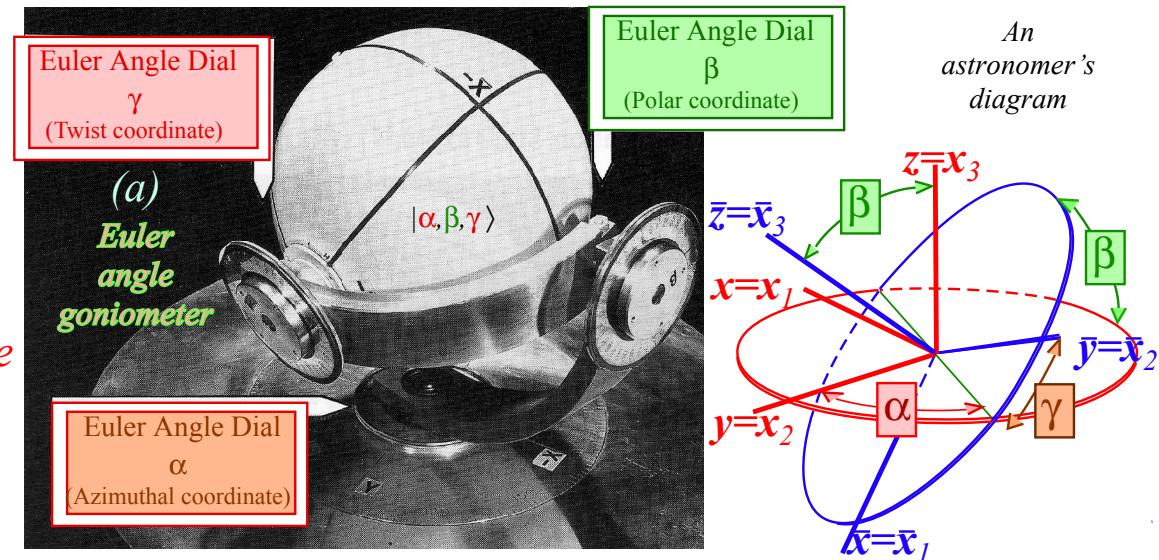
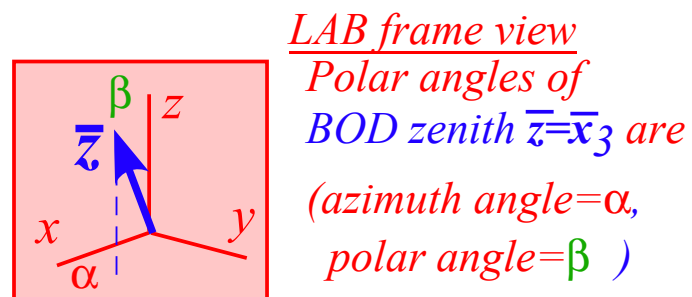
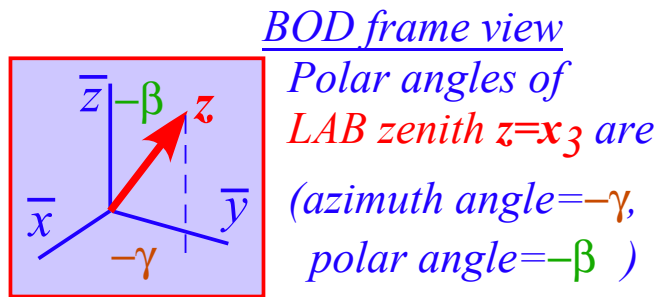
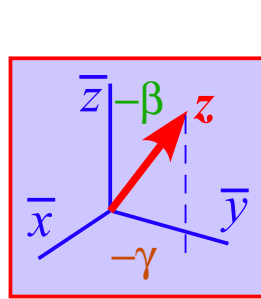

Fig. 10.A.3-4 Mechanical device demonstrating Euler angles (α, β, γ)

Euler's rotation state definition using rotations $\mathbf{R}(\alpha, 0, 0)$, $\mathbf{R}(0, \beta, 0)$, and $\mathbf{R}(0, 0, \gamma)$

Spin-1 (3D-real vector) case



BOD frame view
Polar angles of LAB zenith $z=x_3$ are
(azimuth angle = $-\gamma$,
polar angle = $-\beta$)

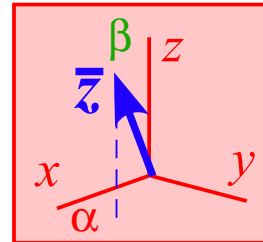

LAB frame view
Polar angles of BOD zenith $\bar{z}=\bar{x}_3$ are
(azimuth angle = α ,
polar angle = β)

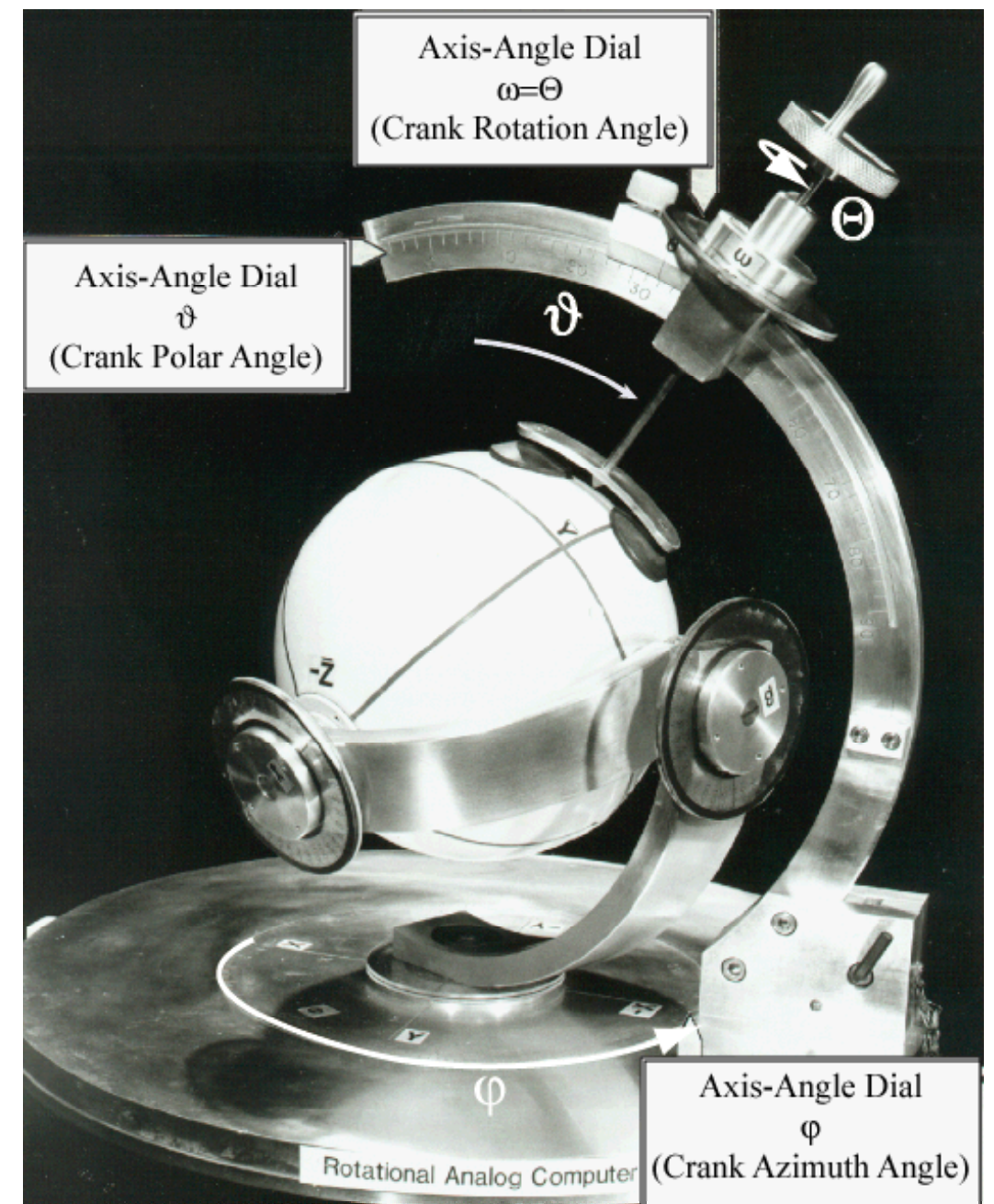
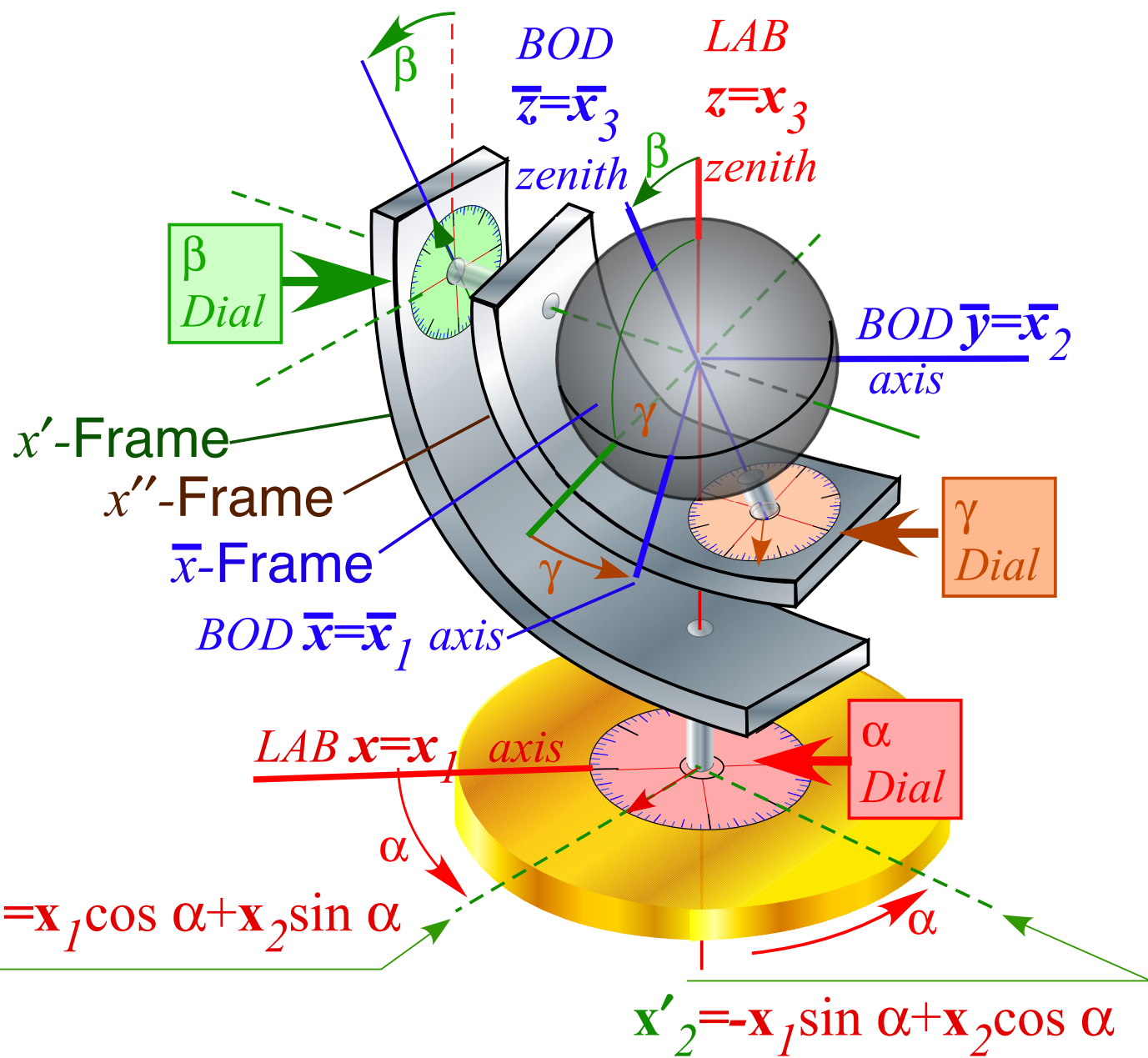
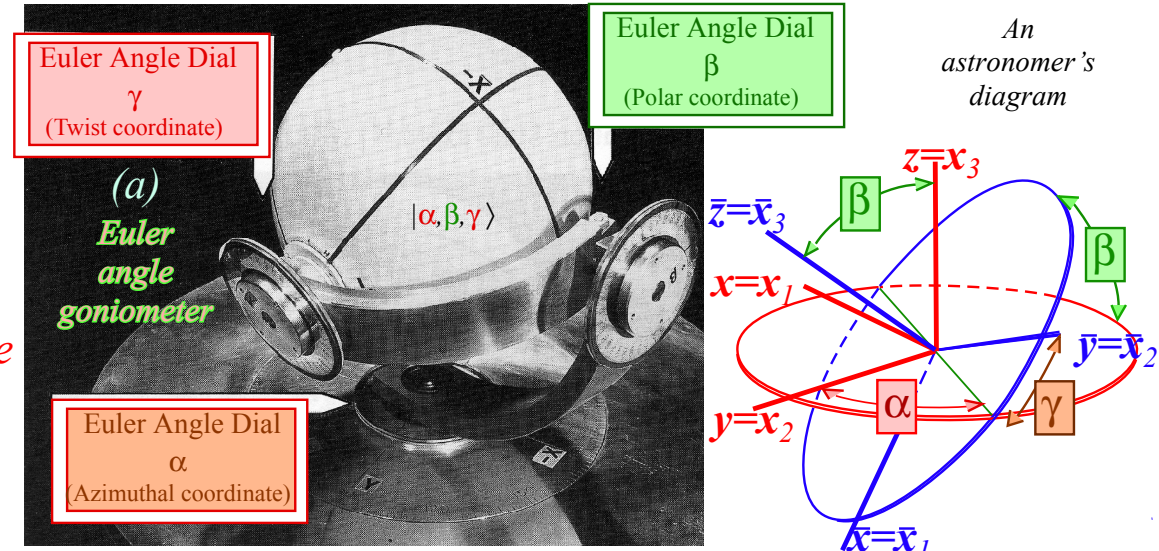

Fig. 10.A.3-4 Mechanical device demonstrating Euler angles (α, β, γ)

Review: How C_2 (Bilateral σ_B reflection) symmetry is eigen-solver

$U(2)$ vs $R(3)$: 2-State Schrodinger: $i\hbar\partial_t|\Psi(t)\rangle = \mathbf{H}|\Psi(t)\rangle$ vs. Classical 2D-HO: $\partial_t^2\mathbf{x} = -\mathbf{K}\cdot\mathbf{x}$

Hamilton-Pauli spinor symmetry (σ -expansion in $ABCD$ -Types) $\mathbf{H} = \omega_\mu \sigma_\mu$

Deriving σ -exponential time evolution (or revolution) operator $\mathbf{U} = e^{-i\mathbf{H}t} = e^{-i\sigma_\mu \omega_\mu t}$

Spinor arithmetic like complex arithmetic

Spinor vector algebra like complex vector algebra

Spinor exponentials like complex exponentials ("Crazy-Thing"-Theorem)

Geometry of $U(2)$ evolution (or $R(3)$ revolution) operator $\mathbf{U} = e^{-i\mathbf{H}t} = e^{-i\sigma_\mu \omega_\mu t}$

The "mysterious" factors of 2 (or 1/2): 2D Spinor vs 3D Spin Vector space

2D Spinor vs 3D vector rotation

NMR Hamiltonian: 3D Spin Moment \mathbf{m} in \mathbf{B} field

➔ Euler's state definition using rotations $\mathbf{R}(\alpha, 0, 0)$, $\mathbf{R}(0, \beta, 0)$, and $\mathbf{R}(0, 0, \gamma)$

Spin-1 (3D-real vector) case

➔ Spin-1/2 (2D-complex spinor) case

3D-real Stokes Vector defines 2D-HO polarization ellipses and spinor states

Asymmetry $S_A = S_Z$, Balance $S_B = S_X$, and Chirality $S_C = S_Y$

Polarization ellipse and spinor state dynamics

Euler's rotation state definition using rotations $\mathbf{R}(\alpha, 0, 0)$, $\mathbf{R}(0, \beta, 0)$, and $\mathbf{R}(0, 0, \gamma)$

Spin-1/2 (2D-complex spinor) case

$$\begin{aligned}
 |a\rangle &= \mathbf{R}(\alpha\beta\gamma)|\uparrow\rangle \\
 &= \mathbf{R}[\alpha \text{ about } Z] \cdot \mathbf{R}[\beta \text{ about } Y] \cdot \mathbf{R}[\gamma \text{ about } Z]|\uparrow\rangle \\
 &= \begin{pmatrix} e^{-i\frac{\alpha}{2}} & 0 \\ 0 & e^{i\frac{\alpha}{2}} \end{pmatrix} \begin{pmatrix} \cos\frac{\beta}{2} & -\sin\frac{\beta}{2} \\ \sin\frac{\beta}{2} & \cos\frac{\beta}{2} \end{pmatrix} \begin{pmatrix} e^{-i\frac{\gamma}{2}} & 0 \\ 0 & e^{i\frac{\gamma}{2}} \end{pmatrix} \begin{pmatrix} A \\ 0 \end{pmatrix}
 \end{aligned}$$

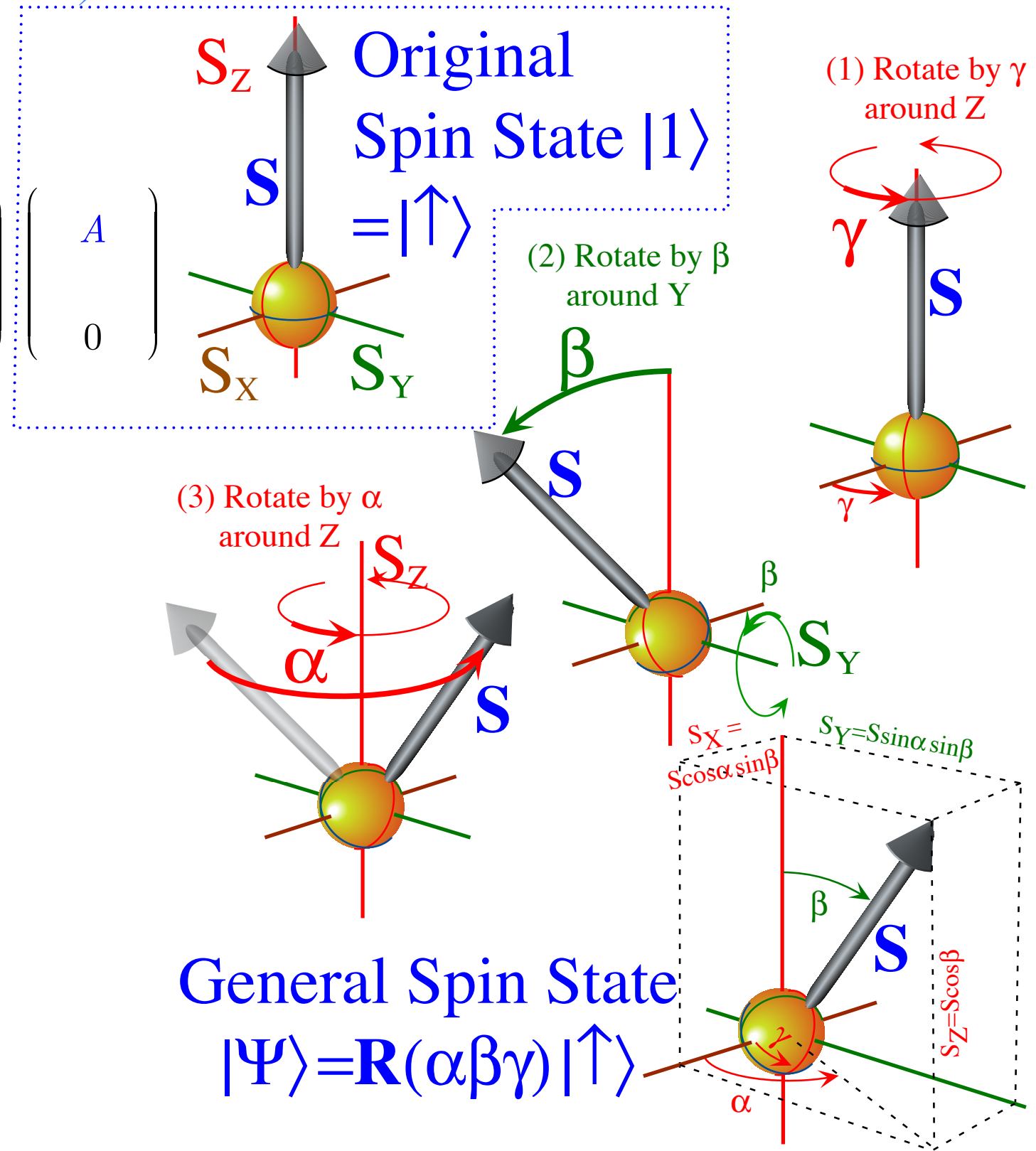

Euler's rotation state definition using rotations $\mathbf{R}(\alpha, 0, 0)$, $\mathbf{R}(0, \beta, 0)$, and $\mathbf{R}(0, 0, \gamma)$

Spin-1/2 (2D-complex spinor) case

$$|a\rangle = \mathbf{R}(\alpha\beta\gamma)|\uparrow\rangle$$

$$= \mathbf{R}[\alpha \text{ about } Z] \cdot \mathbf{R}[\beta \text{ about } Y] \cdot \mathbf{R}[\gamma \text{ about } Z]|\uparrow\rangle$$

$$= \begin{pmatrix} e^{-i\frac{\alpha}{2}} & 0 \\ 0 & e^{i\frac{\alpha}{2}} \end{pmatrix} \begin{pmatrix} \cos\frac{\beta}{2} & -\sin\frac{\beta}{2} \\ \sin\frac{\beta}{2} & \cos\frac{\beta}{2} \end{pmatrix} \begin{pmatrix} e^{-i\frac{\gamma}{2}} & 0 \\ 0 & e^{i\frac{\gamma}{2}} \end{pmatrix} \begin{pmatrix} A \\ 0 \end{pmatrix}$$

$$= \begin{pmatrix} e^{-i\frac{\alpha+\gamma}{2}} \cos\frac{\beta}{2} & -e^{-i\frac{\alpha-\gamma}{2}} \sin\frac{\beta}{2} \\ e^{i\frac{\alpha-\gamma}{2}} \sin\frac{\beta}{2} & e^{i\frac{\alpha+\gamma}{2}} \cos\frac{\beta}{2} \end{pmatrix} \begin{pmatrix} A \\ 0 \end{pmatrix}$$

$$= A \begin{pmatrix} e^{-i\frac{\alpha}{2}} \cos\frac{\beta}{2} \\ e^{i\frac{\alpha}{2}} \sin\frac{\beta}{2} \end{pmatrix} e^{-i\frac{\gamma}{2}} = \begin{pmatrix} x_1 + ip_1 \\ x_2 + ip_2 \end{pmatrix}$$

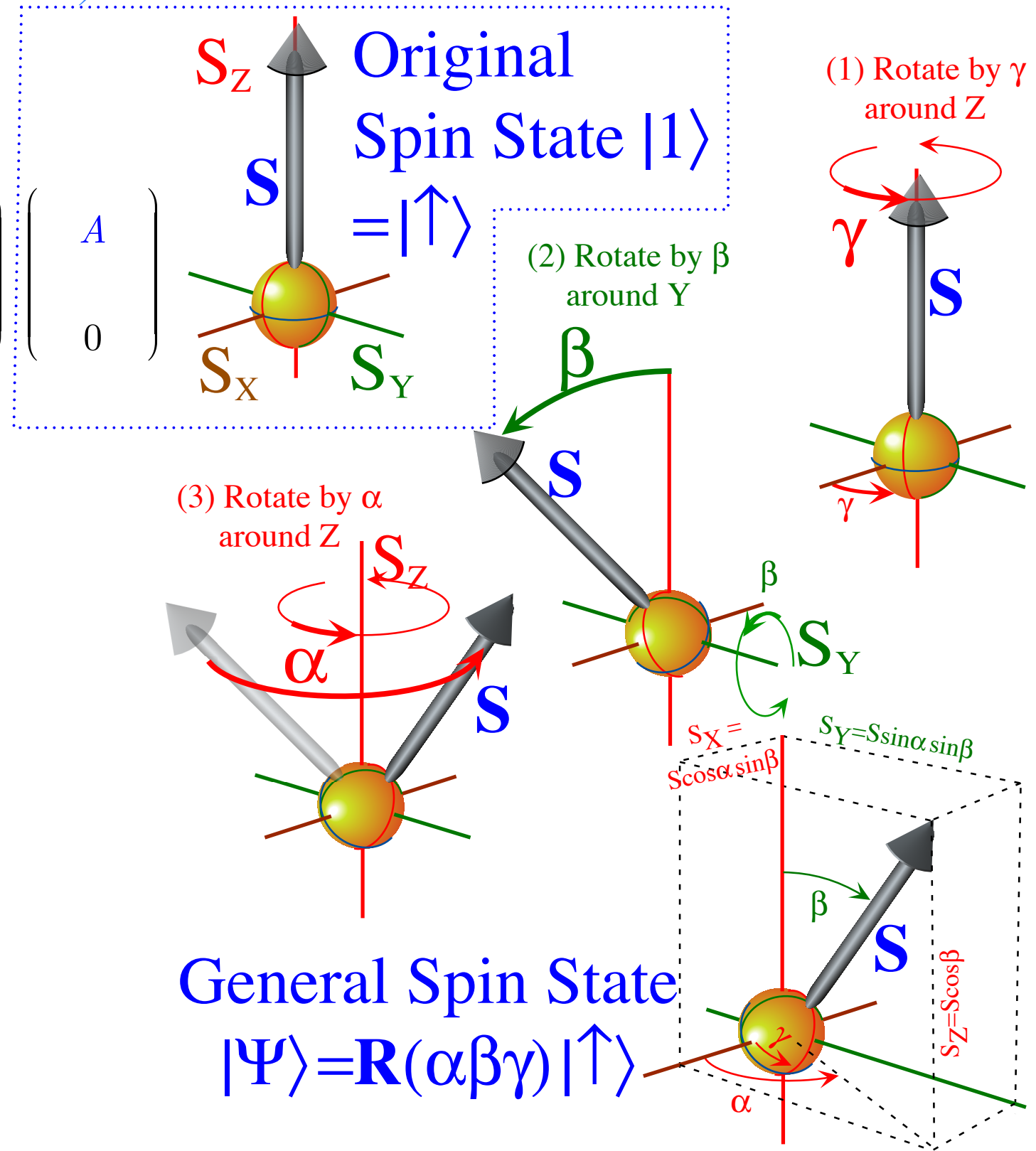

General Spin State
 $|\Psi\rangle = \mathbf{R}(\alpha\beta\gamma)|\uparrow\rangle$

Review: How C_2 (Bilateral σ_B reflection) symmetry is eigen-solver

$U(2)$ vs $R(3)$: 2-State Schrodinger: $i\hbar\partial_t|\Psi(t)\rangle = \mathbf{H}|\Psi(t)\rangle$ vs. Classical 2D-HO: $\partial_t^2\mathbf{x} = -\mathbf{K}\cdot\mathbf{x}$

Hamilton-Pauli spinor symmetry (σ -expansion in $ABCD$ -Types) $\mathbf{H} = \omega_\mu \sigma_\mu$

Deriving σ -exponential time evolution (or revolution) operator $\mathbf{U} = e^{-i\mathbf{H}t} = e^{-i\sigma_\mu \omega_\mu t}$

Spinor arithmetic like complex arithmetic

Spinor vector algebra like complex vector algebra

Spinor exponentials like complex exponentials ("Crazy-Thing"-Theorem)

Geometry of $U(2)$ evolution (or $R(3)$ revolution) operator $\mathbf{U} = e^{-i\mathbf{H}t} = e^{-i\sigma_\mu \omega_\mu t}$

The "mysterious" factors of 2 (or 1/2): 2D Spinor vs 3D Spin Vector space

2D Spinor vs 3D vector rotation

NMR Hamiltonian: 3D Spin Moment \mathbf{m} in \mathbf{B} field

Euler's state definition using rotations $\mathbf{R}(\alpha, 0, 0)$, $\mathbf{R}(0, \beta, 0)$, and $\mathbf{R}(0, 0, \gamma)$

Spin-1 (3D-real vector) case

Spin-1/2 (2D-complex spinor) case

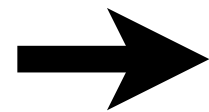

3D-real Stokes Vector defines 2D-HO polarization ellipses and spinor states



Asymmetry $S_A = S_Z$, Balance $S_B = S_X$, and Chirality $S_C = S_Y$

Polarization ellipse and spinor state dynamics

3D-real Stokes Vector defines 2D-HO polarization ellipses and spinor states

Asymmetry $S_A = S_Z$, *Balance* $S_B = S_X$, and *Chirality* $S_C = S_Y$

$$\begin{pmatrix} a_1 \\ a_2 \end{pmatrix} = \begin{pmatrix} x_1 + ip_1 \\ x_2 + ip_2 \end{pmatrix}$$

Each point $\{E_1, E_2\}$ defines 2D-HO phase space or analogous Ψ -space given by 2D amplitude array:
This defines real 3D spin vector (S_A, S_B, S_C) “pointing” to a polarization ellipse or state.

$$\text{Asymmetry } S_A = \frac{1}{2}(a|\sigma_A|a) = \frac{1}{2} \begin{pmatrix} a_1^* & a_2^* \end{pmatrix} \begin{pmatrix} 1 & 0 \\ 0 & -1 \end{pmatrix} \begin{pmatrix} a_1 \\ a_2 \end{pmatrix} = \frac{1}{2}[a_1^*a_1 - a_2^*a_2] = \frac{1}{2}[x_1^2 + p_1^2 - x_2^2 - p_2^2]$$

$$\text{Balance } S_B = \frac{1}{2}(a|\sigma_B|a) = \frac{1}{2} \begin{pmatrix} a_1^* & a_2^* \end{pmatrix} \begin{pmatrix} 0 & 1 \\ 1 & 0 \end{pmatrix} \begin{pmatrix} a_1 \\ a_2 \end{pmatrix} = \frac{1}{2}[a_1^*a_2 + a_2^*a_1] = [p_1p_2 + x_1x_2]$$

$$\text{Chirality } S_C = \frac{1}{2}(a|\sigma_C|a) = \frac{1}{2} \begin{pmatrix} a_1^* & a_2^* \end{pmatrix} \begin{pmatrix} 0 & -i \\ i & 0 \end{pmatrix} \begin{pmatrix} a_1 \\ a_2 \end{pmatrix} = \frac{-i}{2}[a_1^*a_2 - a_2^*a_1] = [x_1p_2 - x_2p_1]$$

3D-real Stokes Vector defines 2D-HO polarization ellipses and spinor states

Asymmetry $S_A = S_Z$, **Balance** $S_B = S_X$, and **Chirality** $S_C = S_Y$

Each point $\{E_1, E_2\}$ defines 2D-HO phase space or analogous Ψ -space given by 2D amplitude array: $\begin{pmatrix} a_1 \\ a_2 \end{pmatrix} = \begin{pmatrix} x_1 + ip_1 \\ x_2 + ip_2 \end{pmatrix} = A \begin{pmatrix} e^{-i\frac{\alpha}{2}} \cos \frac{\beta}{2} \\ e^{i\frac{\alpha}{2}} \sin \frac{\beta}{2} \end{pmatrix} e^{-i\frac{\gamma}{2}}$
 This defines real 3D spin vector (S_A, S_B, S_C) "pointing" to a polarization ellipse or state.

$$\text{Asymmetry } S_A = \frac{1}{2} \langle a | \sigma_A | a \rangle = \frac{1}{2} \begin{pmatrix} a_1^* & a_2^* \end{pmatrix} \begin{pmatrix} 1 & 0 \\ 0 & -1 \end{pmatrix} \begin{pmatrix} a_1 \\ a_2 \end{pmatrix} = \frac{1}{2} [a_1^* a_1 - a_2^* a_2] = \frac{1}{2} [x_1^2 + p_1^2 - x_2^2 - p_2^2] = \frac{I}{2} [\cos^2 \frac{\beta}{2} - \sin^2 \frac{\beta}{2}] = \frac{I}{2} \cos \beta$$

$$\text{Balance } S_B = \frac{1}{2} \langle a | \sigma_B | a \rangle = \frac{1}{2} \begin{pmatrix} a_1^* & a_2^* \end{pmatrix} \begin{pmatrix} 0 & 1 \\ 1 & 0 \end{pmatrix} \begin{pmatrix} a_1 \\ a_2 \end{pmatrix} = \frac{1}{2} [a_1^* a_2 + a_2^* a_1] = [p_1 p_2 + x_1 x_2] = I \left[-\sin \frac{\alpha + \gamma}{2} \sin \frac{\alpha - \gamma}{2} + \cos \frac{\alpha + \gamma}{2} \cos \frac{\alpha - \gamma}{2} \right] \cos \frac{\beta}{2} \sin \frac{\beta}{2} = \frac{I}{2} \cos \alpha \sin \beta$$

$$\text{Chirality } S_C = \frac{1}{2} \langle a | \sigma_C | a \rangle = \frac{1}{2} \begin{pmatrix} a_1^* & a_2^* \end{pmatrix} \begin{pmatrix} 0 & -i \\ i & 0 \end{pmatrix} \begin{pmatrix} a_1 \\ a_2 \end{pmatrix} = \frac{-i}{2} [a_1^* a_2 - a_2^* a_1] = [x_1 p_2 - x_2 p_1] = I \left[\cos \frac{\alpha + \gamma}{2} \sin \frac{\alpha - \gamma}{2} - \cos \frac{\alpha - \gamma}{2} \sin \frac{\alpha + \gamma}{2} \right] \cos \frac{\beta}{2} \sin \frac{\beta}{2} = \frac{I}{2} \sin \alpha \sin \beta$$

General Spin State
 $|\Psi\rangle = \mathbf{R}(\alpha\beta\gamma) |\uparrow\rangle$

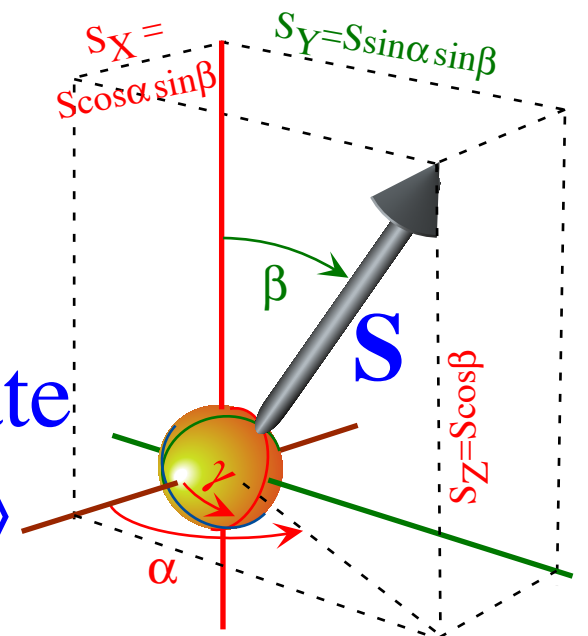

3D-real Stokes Vector defines 2D-HO polarization ellipses and spinor states

Asymmetry $S_A = S_Z$, Balance $S_B = S_X$, and Chirality $S_C = S_Y$

Each point $\{E_1, E_2\}$ defines 2D-HO phase space or analogous Ψ -space given by 2D amplitude array: $\begin{pmatrix} a_1 \\ a_2 \end{pmatrix} = \begin{pmatrix} x_1 + ip_1 \\ x_2 + ip_2 \end{pmatrix} = A \begin{pmatrix} e^{-i\frac{\alpha}{2}} \cos \frac{\beta}{2} \\ e^{i\frac{\alpha}{2}} \sin \frac{\beta}{2} \end{pmatrix} e^{-i\frac{\gamma}{2}}$
 This defines real 3D spin vector (S_A, S_B, S_C) "pointing" to a polarization ellipse or state.

$$\begin{aligned}
 \text{Asymmetry } S_A &= \frac{1}{2} \langle a | \sigma_A | a \rangle = \frac{1}{2} \begin{pmatrix} a_1^* & a_2^* \end{pmatrix} \begin{pmatrix} 1 & 0 \\ 0 & -1 \end{pmatrix} \begin{pmatrix} a_1 \\ a_2 \end{pmatrix} = \frac{1}{2} [a_1^* a_1 - a_2^* a_2] = \frac{1}{2} [x_1^2 + p_1^2 - x_2^2 - p_2^2] = \frac{I}{2} [\cos^2 \frac{\beta}{2} - \sin^2 \frac{\beta}{2}] = \frac{I}{2} \cos \beta \\
 \text{Balance } S_B &= \frac{1}{2} \langle a | \sigma_B | a \rangle = \frac{1}{2} \begin{pmatrix} a_1^* & a_2^* \end{pmatrix} \begin{pmatrix} 0 & 1 \\ 1 & 0 \end{pmatrix} \begin{pmatrix} a_1 \\ a_2 \end{pmatrix} = \frac{1}{2} [a_1^* a_2 + a_2^* a_1] = [p_1 p_2 + x_1 x_2] = I \left[-\sin \frac{\alpha + \gamma}{2} \sin \frac{\alpha - \gamma}{2} + \cos \frac{\alpha + \gamma}{2} \cos \frac{\alpha - \gamma}{2} \right] \cos \frac{\beta}{2} \sin \frac{\beta}{2} = \frac{I}{2} \cos \alpha \sin \beta \\
 \text{Chirality } S_C &= \frac{1}{2} \langle a | \sigma_C | a \rangle = \frac{1}{2} \begin{pmatrix} a_1^* & a_2^* \end{pmatrix} \begin{pmatrix} 0 & -i \\ i & 0 \end{pmatrix} \begin{pmatrix} a_1 \\ a_2 \end{pmatrix} = \frac{-i}{2} [a_1^* a_2 - a_2^* a_1] = [x_1 p_2 - x_2 p_1] = I \left[\cos \frac{\alpha + \gamma}{2} \sin \frac{\alpha - \gamma}{2} - \cos \frac{\alpha - \gamma}{2} \sin \frac{\alpha + \gamma}{2} \right] \cos \frac{\beta}{2} \sin \frac{\beta}{2} = \frac{I}{2} \sin \alpha \sin \beta
 \end{aligned}$$

General Spin State
 $|\Psi\rangle = \mathbf{R}(\alpha\beta\gamma) |\uparrow\rangle$

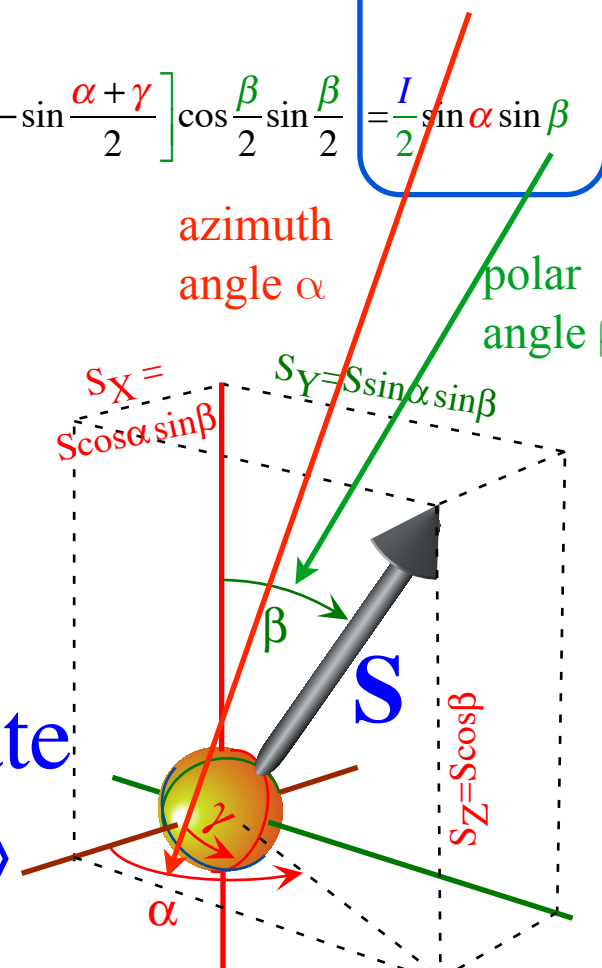

3D-real Stokes Vector defines 2D-HO polarization ellipses and spinor states

Asymmetry $S_A = S_Z$, **Balance** $S_B = S_X$, and **Chirality** $S_C = S_Y$

Each point $\{E_1, E_2\}$ defines 2D-HO phase space or analogous Ψ -space given by 2D amplitude array: $\begin{pmatrix} a_1 \\ a_2 \end{pmatrix} = \begin{pmatrix} x_1 + ip_1 \\ x_2 + ip_2 \end{pmatrix} = A \begin{pmatrix} e^{-i\frac{\alpha}{2}} \cos \frac{\beta}{2} \\ e^{i\frac{\alpha}{2}} \sin \frac{\beta}{2} \end{pmatrix} e^{-i\frac{\gamma}{2}}$
 This defines real 3D spin vector (S_A, S_B, S_C) "pointing" to a polarization ellipse or state.

$$\begin{aligned}
 \text{Asymmetry } S_A &= \frac{1}{2}(a|\sigma_A|a) = \frac{1}{2} \begin{pmatrix} a_1^* & a_2^* \end{pmatrix} \begin{pmatrix} 1 & 0 \\ 0 & -1 \end{pmatrix} \begin{pmatrix} a_1 \\ a_2 \end{pmatrix} = \frac{1}{2}[a_1^* a_1 - a_2^* a_2] = \frac{1}{2}[x_1^2 + p_1^2 - x_2^2 - p_2^2] = \frac{I}{2}[\cos^2 \frac{\beta}{2} - \sin^2 \frac{\beta}{2}] = \frac{I}{2} \cos \beta \\
 \text{Balance } S_B &= \frac{1}{2}(a|\sigma_B|a) = \frac{1}{2} \begin{pmatrix} a_1^* & a_2^* \end{pmatrix} \begin{pmatrix} 0 & 1 \\ 1 & 0 \end{pmatrix} \begin{pmatrix} a_1 \\ a_2 \end{pmatrix} = \frac{1}{2}[a_1^* a_2 + a_2^* a_1] = [p_1 p_2 + x_1 x_2] = I \left[-\sin \frac{\alpha+\gamma}{2} \sin \frac{\alpha-\gamma}{2} + \cos \frac{\alpha+\gamma}{2} \cos \frac{\alpha-\gamma}{2} \right] \cos \frac{\beta}{2} \sin \frac{\beta}{2} = \frac{I}{2} \cos \alpha \sin \beta \\
 \text{Chirality } S_C &= \frac{1}{2}(a|\sigma_C|a) = \frac{1}{2} \begin{pmatrix} a_1^* & a_2^* \end{pmatrix} \begin{pmatrix} 0 & -i \\ i & 0 \end{pmatrix} \begin{pmatrix} a_1 \\ a_2 \end{pmatrix} = \frac{-i}{2}[a_1^* a_2 - a_2^* a_1] = [x_1 p_2 - x_2 p_1] = I \left[\cos \frac{\alpha+\gamma}{2} \sin \frac{\alpha-\gamma}{2} - \cos \frac{\alpha-\gamma}{2} \sin \frac{\alpha+\gamma}{2} \right] \cos \frac{\beta}{2} \sin \frac{\beta}{2} = \frac{I}{2} \sin \alpha \sin \beta
 \end{aligned}$$

(a) Real Spinor Space Picture (2D-Oscillator Orbit)

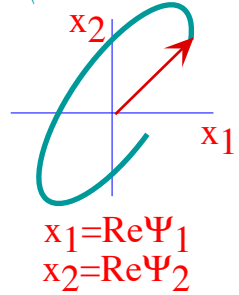

(b) 2-Phasor U(2) Spinor Picture

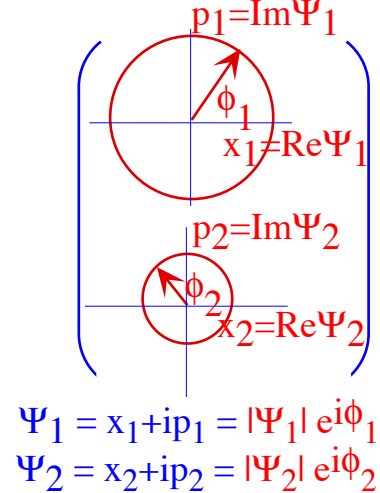

(c) 3-Dimensional Real R(3)-SU(2) Vector Picture

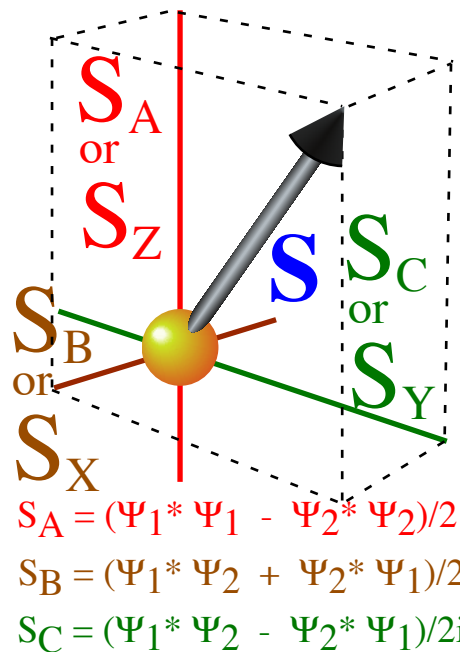

General Spin State $|\Psi\rangle = \mathbf{R}(\alpha\beta\gamma) |\uparrow\rangle$

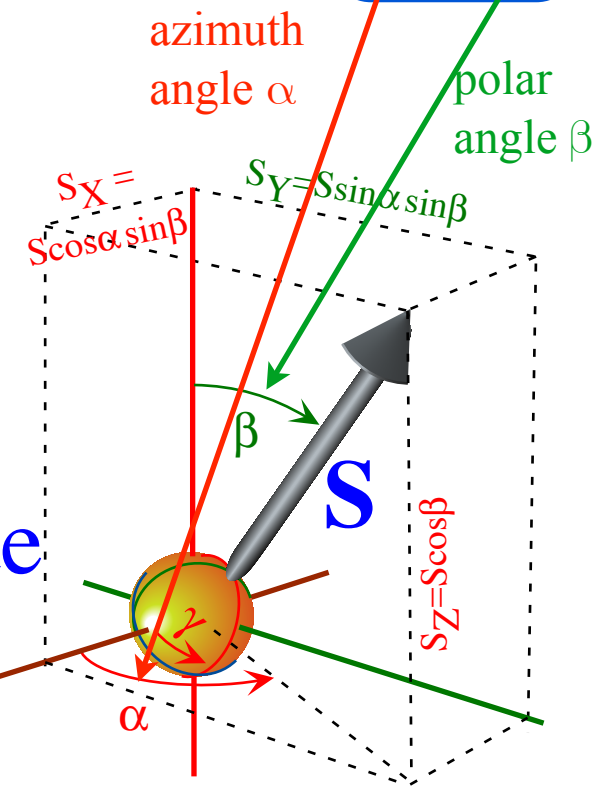

Fig. 10.5.2 Spinor, phasor, and vector descriptions of 2-state systems .

Review: How C_2 (Bilateral σ_B reflection) symmetry is eigen-solver

$U(2)$ vs $R(3)$: 2-State Schrodinger: $i\hbar\partial_t|\Psi(t)\rangle = \mathbf{H}|\Psi(t)\rangle$ vs. Classical 2D-HO: $\partial_t^2\mathbf{x} = -\mathbf{K}\cdot\mathbf{x}$

Hamilton-Pauli spinor symmetry (σ -expansion in ABCD-Types) $\mathbf{H} = \omega_\mu \sigma_\mu$

Deriving σ -exponential time evolution (or revolution) operator $\mathbf{U} = e^{-i\mathbf{H}t} = e^{-i\sigma_\mu \omega_\mu t}$

Spinor arithmetic like complex arithmetic

Spinor vector algebra like complex vector algebra

Spinor exponentials like complex exponentials ("Crazy-Thing"-Theorem)

Geometry of $U(2)$ evolution (or $R(3)$ revolution) operator $\mathbf{U} = e^{-i\mathbf{H}t} = e^{-i\sigma_\mu \omega_\mu t}$

The "mysterious" factors of 2 (or 1/2): 2D Spinor vs 3D Spin Vector space

2D Spinor vs 3D vector rotation

NMR Hamiltonian: 3D Spin Moment \mathbf{m} in \mathbf{B} field

Euler's state definition using rotations $\mathbf{R}(\alpha, 0, 0)$, $\mathbf{R}(0, \beta, 0)$, and $\mathbf{R}(0, 0, \gamma)$

Spin-1 (3D-real vector) case

Spin-1/2 (2D-complex spinor) case

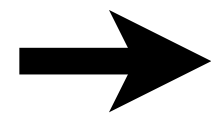

3D-real Stokes Vector defines 2D-HO polarization ellipses and spinor states

Asymmetry $S_A = S_Z$, Balance $S_B = S_X$, and Chirality $S_C = S_Y$

➔ Polarization ellipse and spinor state dynamics

Polarization ellipse and spinor state dynamics

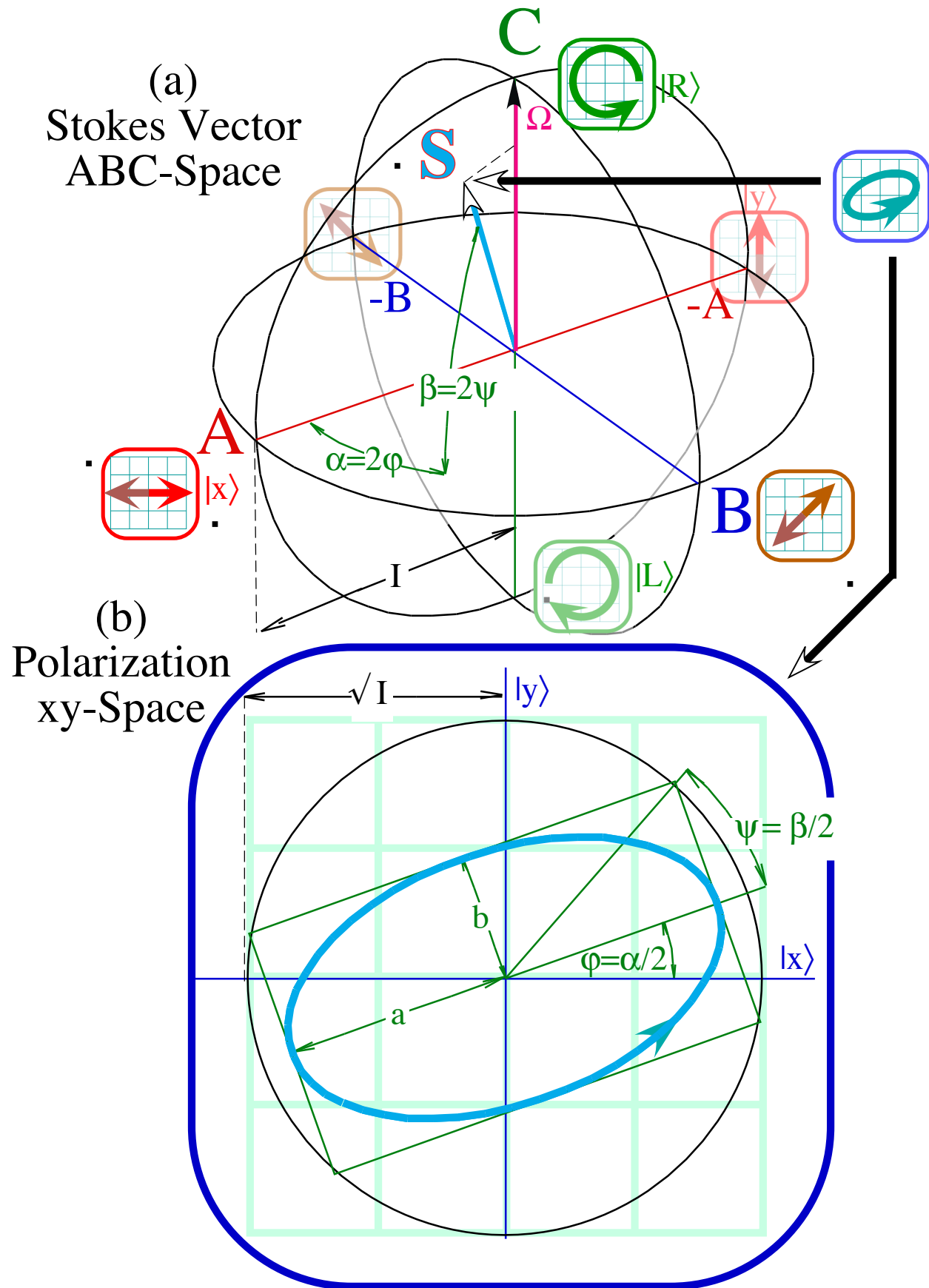

Fig. 10.B.3 Polarization variables (a) Stokes real-vector space (ABC) (b) Complex xy-spinor-space (x_1, x_2) .

Polarization ellipse and spinor state dynamics

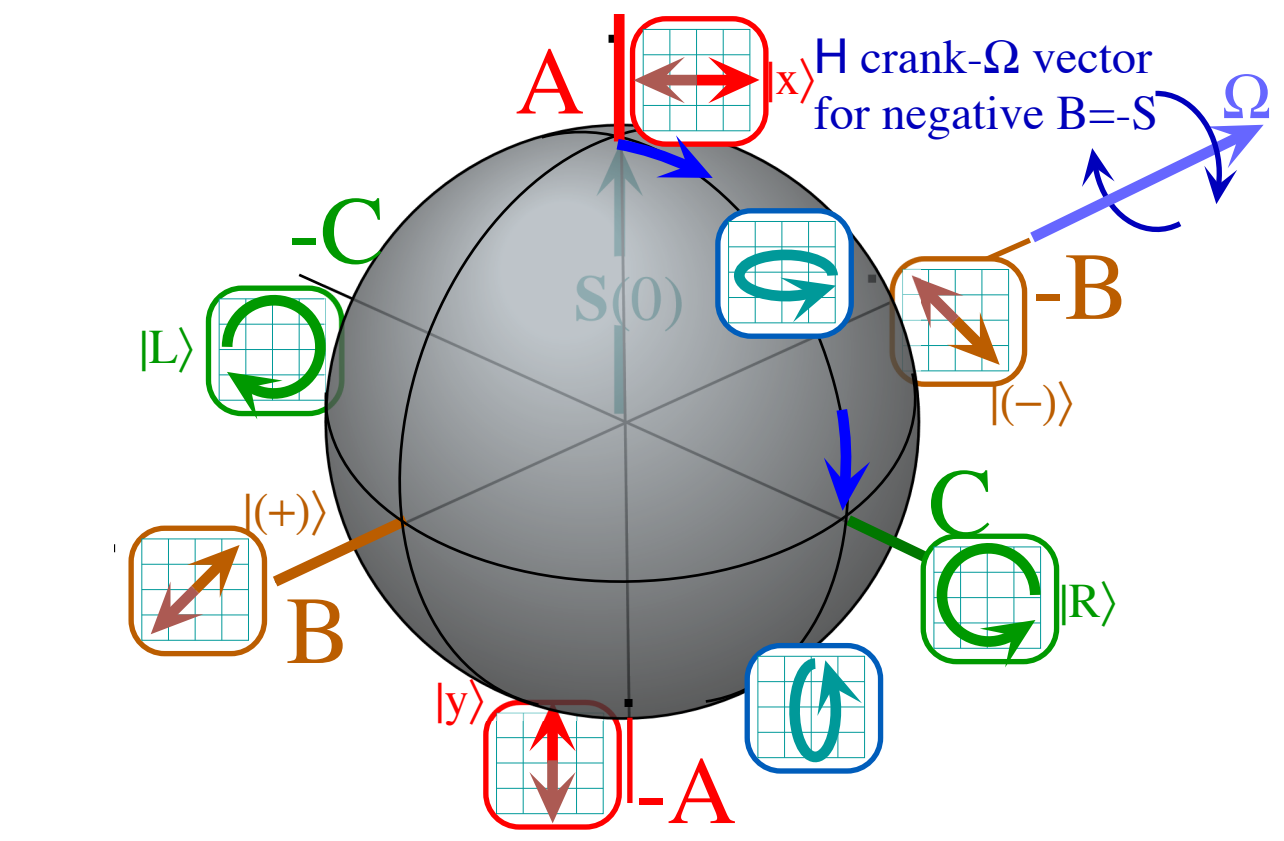
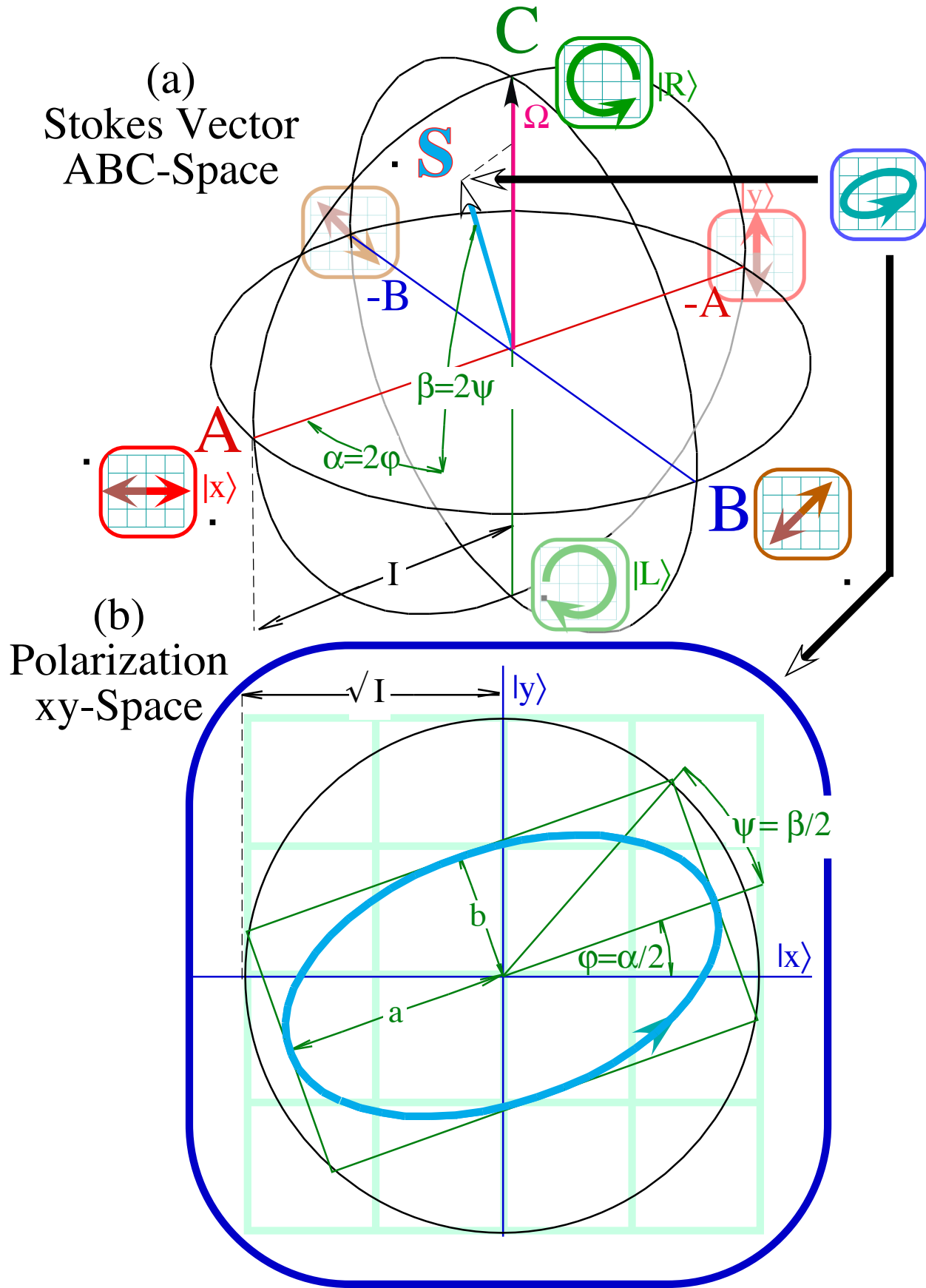

Fig. 10.5.5 Time evolution of a B-type beat. S-vector rotates from A to C to -A to -C and back to A.

Fig. 10.B.3 Polarization variables (a) Stokes real-vector space (ABC) (b) Complex xy-spinor-space (x_1, x_2).

Polarization ellipse and spinor state dynamics

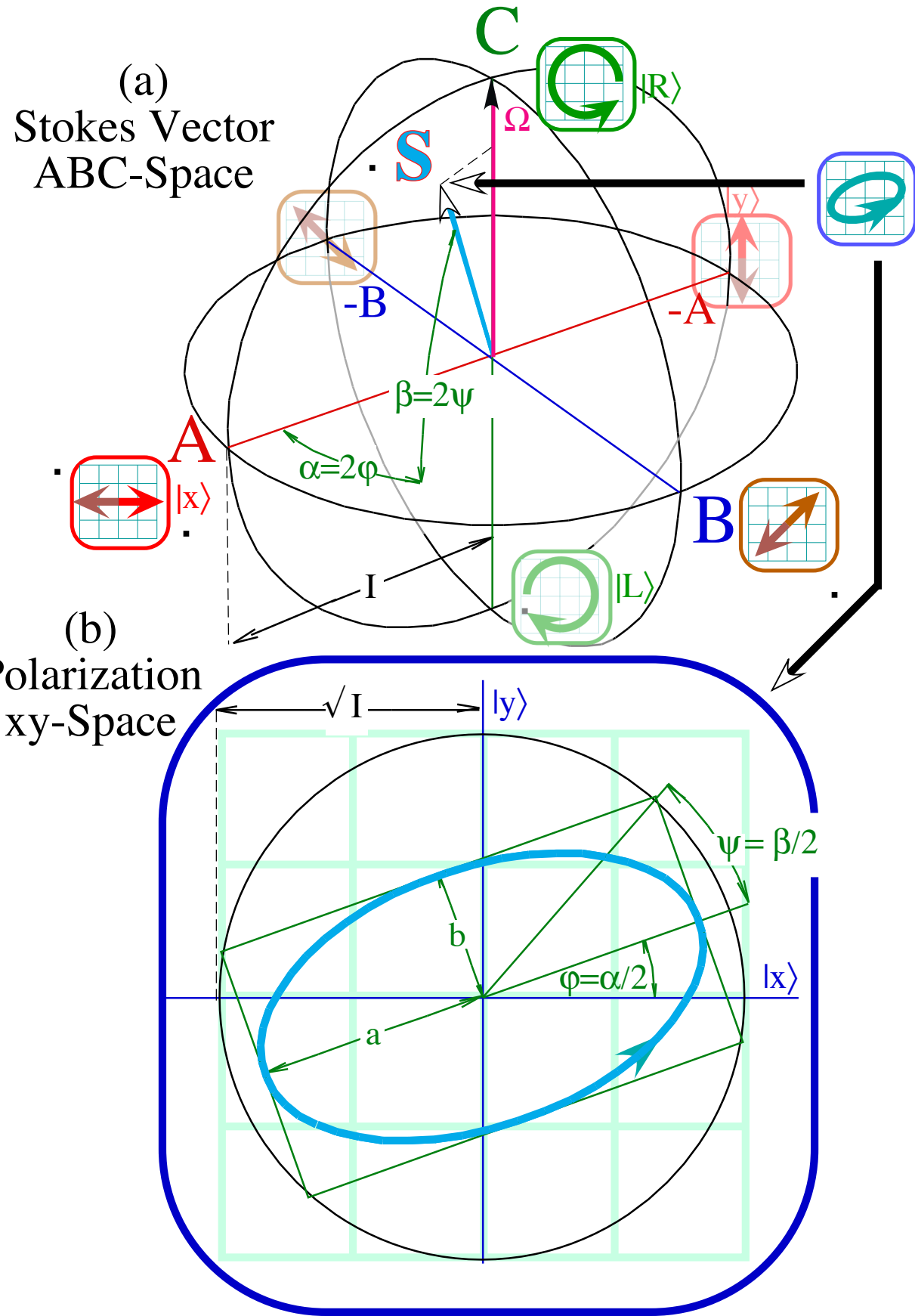

Fig. 3.4.5 Polarization variables (a) Stokes real-vector space (ABC) (b) Complex xy-spinor-space (x_1, x_2) .

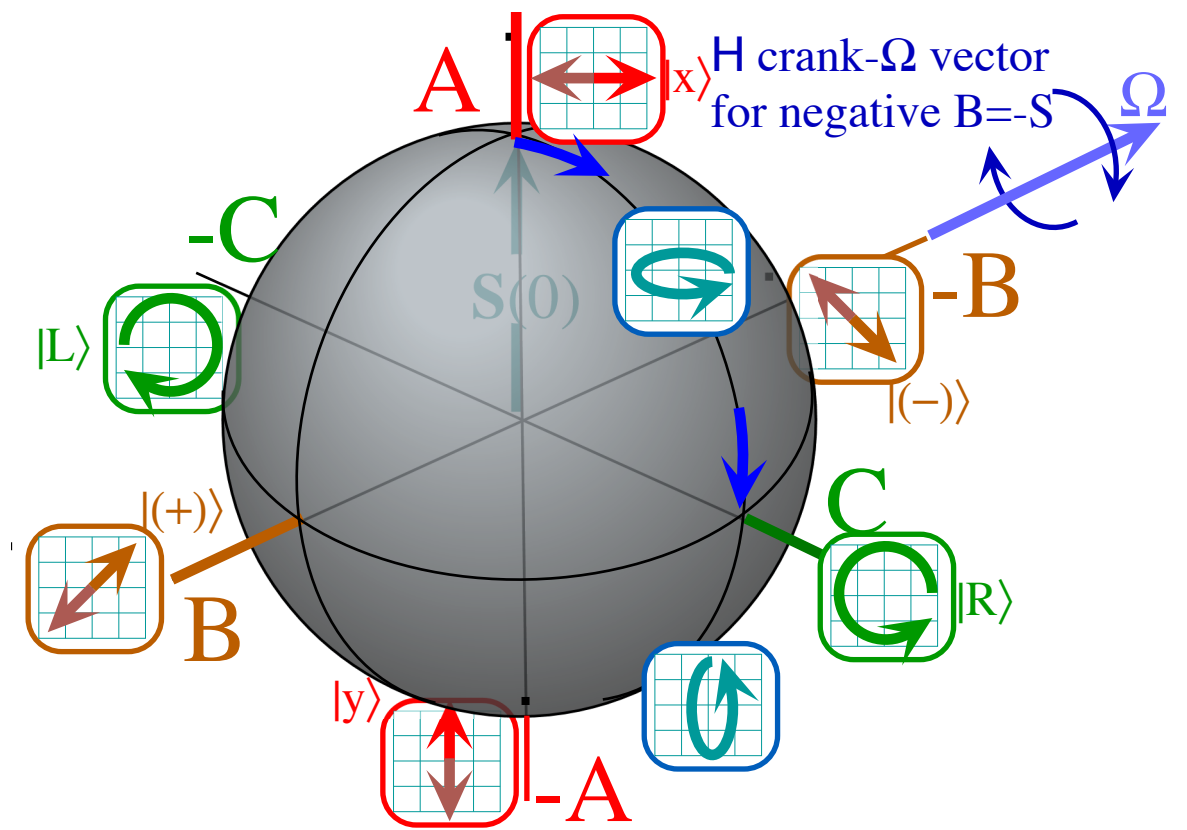
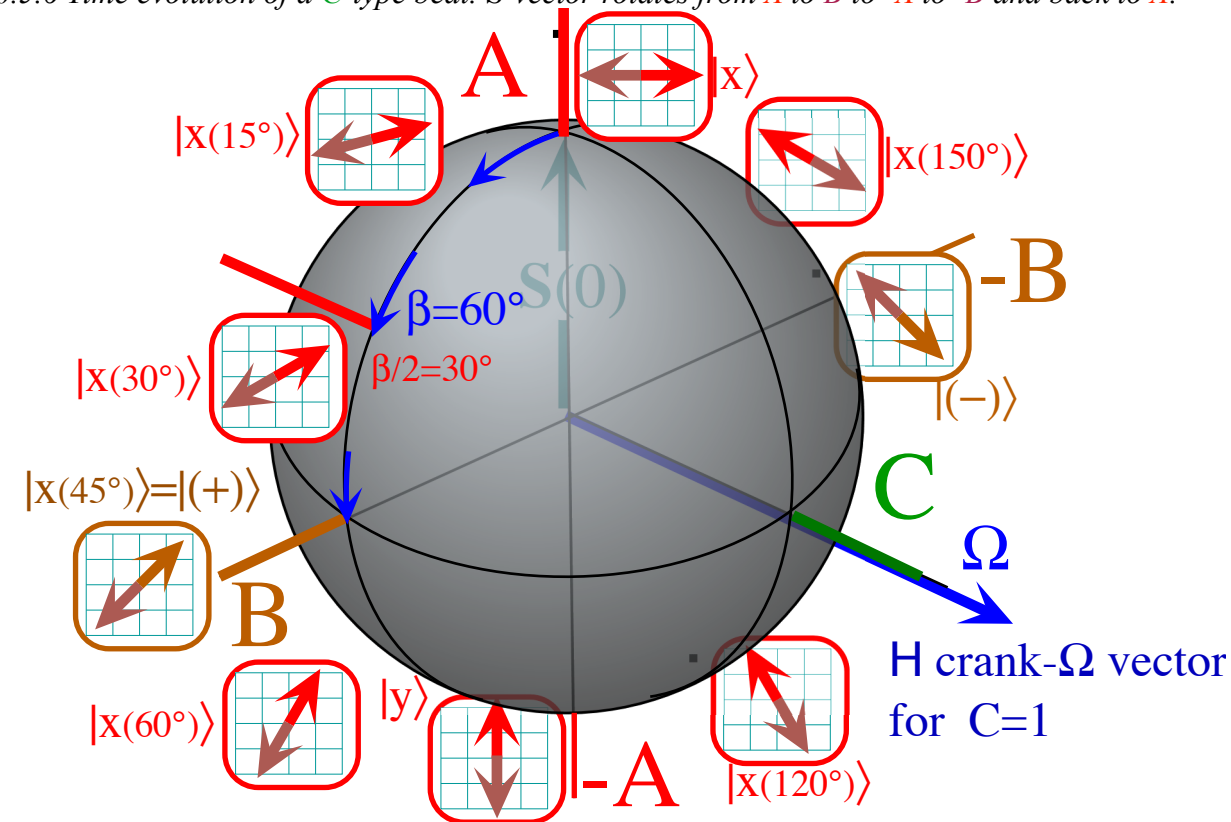

Fig. 10.5.5 Time evolution of a B-type beat. S-vector rotates from A to C to -A to -C and back to A.

Fig. 10.5.6 Time evolution of a C-type beat. S-vector rotates from A to B to -A to -B and back to A.



U(2) World : Complex 2D Spinors

2-State ket $|\Psi\rangle =$

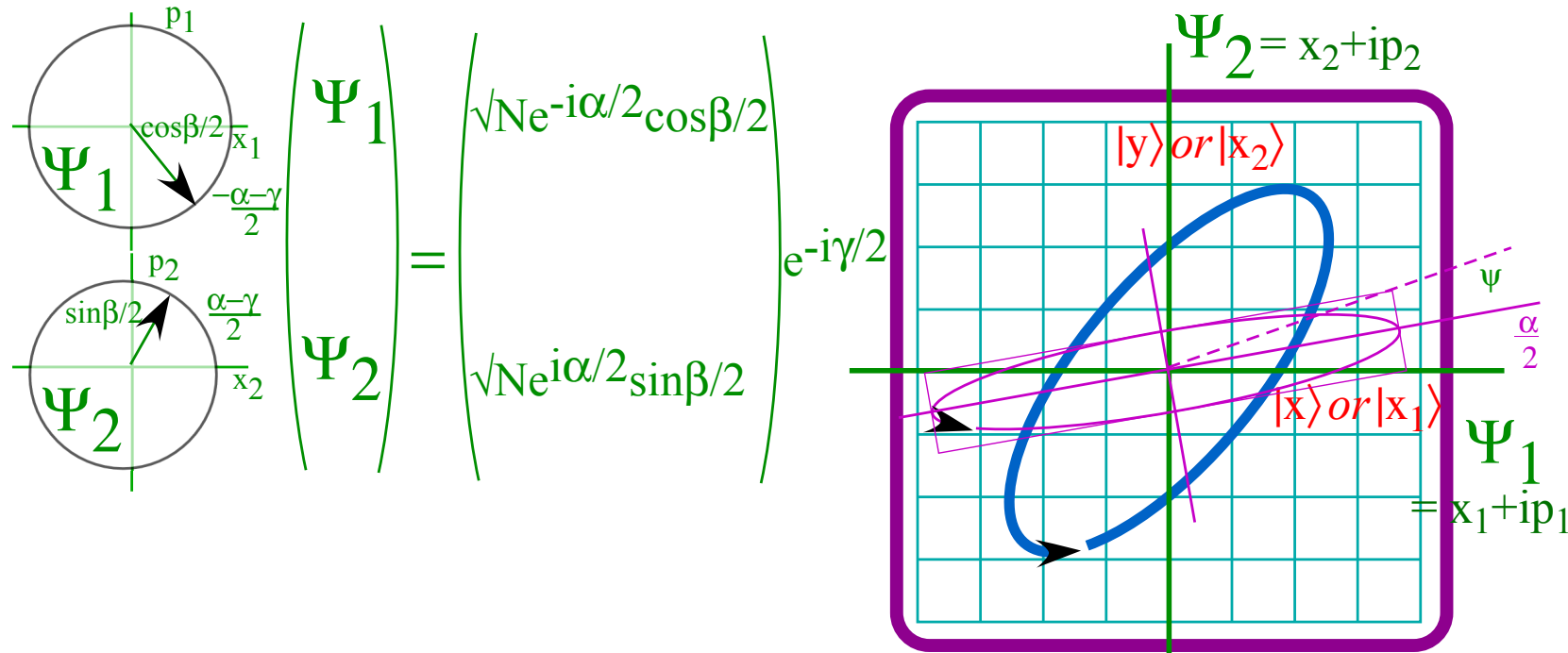

R(3) World : Real 3D Vectors

$|\Psi\rangle$ State Spin Vector \mathbf{S}

$$\begin{pmatrix} s_B \\ s_C \\ s_A \end{pmatrix} = \begin{pmatrix} N \sin\beta \cos\alpha \\ N \sin\beta \sin\alpha \\ N \cos\beta \end{pmatrix} \frac{1}{2}$$

(for $\alpha=15^\circ$ $\beta=45^\circ$)

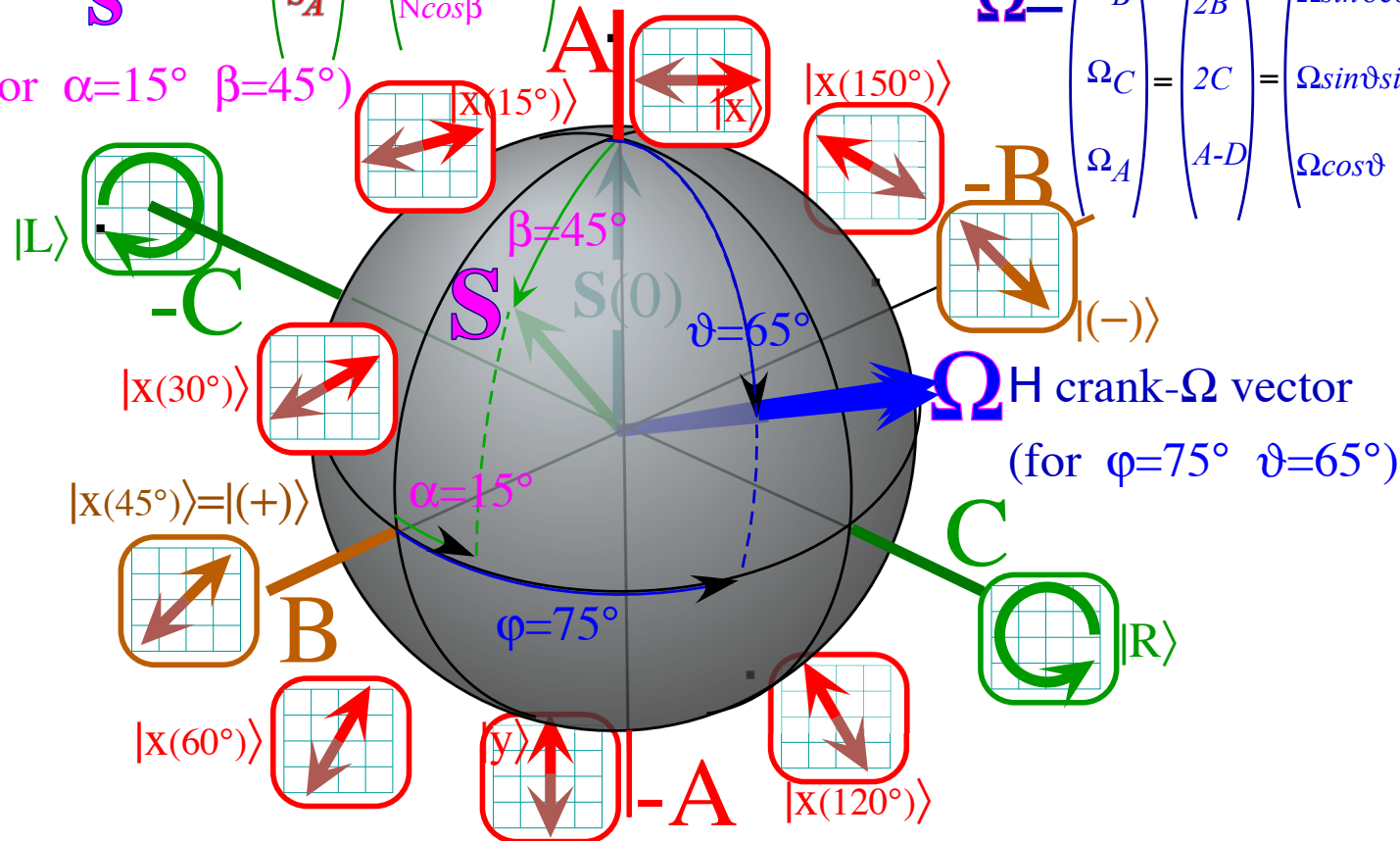

H-Operator Angular velocity

$$\Omega = \begin{pmatrix} \Omega_B \\ \Omega_C \\ \Omega_A \end{pmatrix} = \begin{pmatrix} 2B \\ 2C \\ A-D \end{pmatrix} = \begin{pmatrix} \Omega \sin\theta \cos\phi \\ \Omega \sin\theta \sin\phi \\ \Omega \cos\theta \end{pmatrix}$$

Ω H crank- Ω vector (for $\phi=75^\circ$ $\theta=65^\circ$)